

# GRE<sup>®</sup> Physics Test Practice Book

## **This practice book contains**

- one actual, full-length GRE<sup>®</sup> Physics Test
- test-taking strategies

## **Become familiar with**

- test structure and content
- test instructions and answering procedures

**Compare your practice test results with the performance of those who took the test at a GRE administration.**

# Table of Contents

Overview.....	3
Test Content .....	3
Preparing for the Test.....	4
Test-Taking Strategies.....	4
What Your Scores Mean .....	5
Taking the Practice Test .....	5
Scoring the Practice Test .....	5
Evaluating Your Performance .....	5
Practice Test.....	7
Worksheet for Scoring the Practice Test .....	87
Score Conversion Table.....	88
Answer Sheet.....	89

Test takers with disabilities or health-related needs who need test preparation materials in an alternate format should contact the ETS Office of Disability Services at [stassd@ets.org](mailto:stassd@ets.org). For additional information, visit [www.ets.org/gre/disabilities](http://www.ets.org/gre/disabilities)

## Overview

The GRE® Physics Test consists of about 100 multiple-choice questions. Testing time is 2 hours and 50 minutes; there are no separately-timed sections.

This publication provides a comprehensive overview of the GRE Physics Test to help you get ready for test day. It is designed to help you:

- Understand what is being tested
- Gain familiarity with the question types
- Review test-taking strategies
- Understand scoring
- Practice taking the test

To learn more about the GRE Subject Tests, visit [www.ets.org/gre](http://www.ets.org/gre).

## Test Content

The test consists of approximately 100 five-choice questions, some of which are based on such materials as diagrams, graphs, experimental data and descriptions of physical situations. The aim of the test is to determine the extent of the test takers' grasp of fundamental principles and their ability to apply these principles in the solution of problems. Most test questions can be answered on the basis of a mastery of the first three years of undergraduate physics. The test questions are constructed to simplify mathematical manipulations. As a result, neither calculators nor tables of logarithms are needed. If the solution to a problem requires the use of logarithms, the necessary values are included with the question.

The International System (SI) of units is used predominantly in the test. A table of information representing various physical constants and a few conversion factors among SI units is presented in the test book. Whenever necessary, additional values of physical constants are printed with the text of the question.

The approximate percentages of the test on the major content topics have been set by the committee of examiners, with input

from a nationwide survey of undergraduate physics curricula. The percentages reflect the committee's determination of the relative emphasis placed on each topic in a typical undergraduate program. These percentages are given below along with the major subtopics included in each content category.

Nearly all the questions in the test will relate to material in this listing; however, there may be occasional questions on other topics not explicitly listed here.

- I. Classical Mechanics (20%)**  
(such as kinematics, Newton's laws, work and energy, oscillatory motion, rotational motion about a fixed axis, dynamics of systems of particles, central forces and celestial mechanics, three-dimensional particle dynamics, Lagrangian and Hamiltonian formalism, non-inertial reference frames, elementary topics in fluid dynamics)
- II. Electromagnetism (18%)**  
(such as electrostatics, currents and DC circuits, magnetic fields in free space, Lorentz force, induction, Maxwell's equations and their applications, electromagnetic waves, AC circuits, magnetic and electric fields in matter)
- III. Optics and Wave Phenomena (9%)**  
(such as wave properties, superposition, interference, diffraction, geometrical optics, polarization, Doppler effect)
- IV. Thermodynamics and Statistical Mechanics (10%)**  
(such as the laws of thermodynamics, thermodynamic processes, equations of state, ideal gases, kinetic theory, ensembles, statistical concepts and calculation of thermodynamic quantities, thermal expansion and heat transfer)
- V. Quantum Mechanics (12%)**  
(such as fundamental concepts, solutions of the Schrödinger equation [including square wells, harmonic oscillators and hydrogenic atoms], spin, angular

momentum, wave function symmetry, elementary perturbation theory)

#### VI. Atomic Physics (10%)

(such as properties of electrons, Bohr model, energy quantization, atomic structure, atomic spectra, selection rules, black-body radiation, x-rays, atoms in electric and magnetic fields)

#### VII. Special Relativity (6%)

(such as introductory concepts, time dilation, length contraction, simultaneity, energy and momentum, four-vectors and Lorentz transformation, velocity addition)

#### VIII. Laboratory Methods (6%)

(such as data and error analysis, electronics, instrumentation, radiation detection, counting statistics, interaction of charged particles with matter, lasers and optical interferometers, dimensional analysis, fundamental applications of probability and statistics)

#### IX. Specialized Topics (9%)

Nuclear and Particle physics (such as nuclear properties, radioactive decay, fission and fusion, reactions, fundamental properties of elementary particles), Condensed Matter (such as crystal structure, x-ray diffraction, thermal properties, electron theory of metals, semiconductors, superconductors), Miscellaneous (such as astrophysics, mathematical methods, computer applications)

## Preparing for the Test

GRE Subject Test questions are designed to measure skills and knowledge gained over a long period of time. Although you might increase your scores to some extent through preparation a few weeks or months before you take the test, last minute cramming is unlikely to be of further help. The following information may be helpful.

- A general review of your college courses is probably the best preparation for the

test. However, the test covers a broad range of subject matter, and no one is expected to be familiar with the content of every question.

- Become familiar with the types of questions in the GRE Physics Test, paying special attention to the directions. If you thoroughly understand the directions before you take the test, you will have more time during the test to focus on the questions themselves.

## Test-Taking Strategies

The questions in the practice test illustrate the types of multiple-choice questions in the test. When you take the actual test, you will mark your answers on a separate machine-scorable answer sheet.

The following are some general test-taking strategies you may want to consider.

- Read the test directions carefully, and work as rapidly as you can without being careless. For each question, choose the best answer from the available options.
- All questions are of equal value; do not waste time pondering individual questions you find extremely difficult or unfamiliar.
- You may want to work through the test quickly, first answering only the questions about which you feel confident, then going back and answering questions that require more thought, and concluding with the most difficult questions if there is time.
- If you decide to change an answer, make sure you completely erase it and fill in the oval corresponding to your desired answer.
- Your score will be determined by the number of questions you answer correctly. Questions you answer incorrectly or for which you mark no answer or more than one answer are counted as incorrect. Nothing is subtracted from a score if you answer a question incorrectly. Therefore, to maximize your score it is better for you

to guess at an answer than not to respond at all.

- Record all answers on your answer sheet. Answers recorded in your test book will not be counted.
- Do not wait until the last few minutes of a testing session to record answers on your answer sheet.

## What Your Scores Mean

The number of questions you answered correctly on the whole test (total correct score) is converted to the total reported scaled score. This conversion ensures that a scaled score reported for any edition of a GRE Physics Test is comparable to the same scaled score earned on any other edition of the test. Thus, equal scaled scores on a particular test indicate essentially equal levels of performance regardless of the test edition taken.

GRE Physics Test total scores are reported on a 200 to 990 score scale in ten-point increments.

Test scores should be compared only with other scores on the Physics Test. For example, a 780 on the Physics Test is not equivalent to a 780 on the Chemistry Test.

## Taking the Practice Test

The practice test begins on page 7. The total time that you should allow for this practice test is 2 hours and 50 minutes. An answer sheet is provided for you to mark your answers to the test questions.

It is best to take this practice test under timed conditions. Find a quiet place to take the test and make sure you have a minimum of 2 hours and 50 minutes available.

To simulate how the administration will be conducted at the test center, print the answer sheet (pages 89 and 90). Then go to the back cover of the test book (page 86) and follow the instructions for completing the identification areas of the answer sheet. When you are ready to begin the test, note the time and begin marking your

answers on the answer sheet. Stop working on the test when 2 hours and 50 minutes have elapsed.

## Scoring the Practice Test

The worksheet on page 87 lists the correct answers to the questions. The “Correct Response” columns are provided for you to mark those questions for which you chose the correct answer.

Mark each question that you answer correctly. Then, add up your correct answers and enter your total number of correct answers in the space labeled “Total Correct” at the bottom of the page. Next, use the “Total Score” conversion tables on page 88 to find the corresponding scaled score. For example, suppose you chose the correct answers to 67 of the questions on the test. The “Total Correct” entry in the conversion table of 67 shows that your total scaled score is 820.

## Evaluating Your Performance

Now that you have scored your test, you may wish to compare your performance with the performance of others who took this test.

The data in the worksheet on page 87 are based on the performance of a sample of the test takers who took the GRE Physics Test in the United States.

The numbers in the column labeled “P+” on the worksheet indicate the percentages of examinees in this sample who answered each question correctly. You may use these numbers as a guide for evaluating your performance on each test question.

Interpretive data based on the scores earned by a recent cohort of test takers are available on the GRE website at [www.ets.org/gre/subject/scores/understand](http://www.ets.org/gre/subject/scores/understand). The interpretive data show, for selected scaled score, the percentage of test takers who received lower scores. To compare yourself with this population, look at the percentage next to the scaled score you earned on the practice test. Note that these interpretive data are updated annually and reported on GRE score reports.

It is important to realize that the conditions under which you tested yourself were not exactly the same as those you will encounter at a test center. It is impossible to predict how different test-taking conditions will affect test performance, and this is only one factor that may account for differences between your practice test scores and your actual test scores.

By comparing your performance on this practice test with the performance of other individuals who took GRE Physics Test, however, you will be able to determine your strengths and weaknesses and can then plan a program of study to prepare yourself for taking the GRE Physics Test under standard conditions.



FORM GR1777

77

GRADUATE RECORD EXAMINATIONS®

# PHYSICS TEST

Copyright © 2013 by Educational Testing Service. All rights reserved.  
GRE, GRADUATE RECORD EXAMINATIONS, ETS, EDUCATIONAL TESTING  
SERVICE and the ETS logos are registered trademarks of Educational Testing Service.

TABLE OF INFORMATION

Rest mass of the electron	$m_e = 9.11 \times 10^{-31} \text{ kg}$
Magnitude of the electron charge	$e = 1.60 \times 10^{-19} \text{ C}$
Avogadro's number	$N_A = 6.02 \times 10^{23}$
Universal gas constant	$R = 8.31 \text{ J/(mol} \cdot \text{K)}$
Boltzmann's constant	$k = 1.38 \times 10^{-23} \text{ J/K}$
Speed of light	$c = 3.00 \times 10^8 \text{ m/s}$
Planck's constant	$h = 6.63 \times 10^{-34} \text{ J} \cdot \text{s} = 4.14 \times 10^{-15} \text{ eV} \cdot \text{s}$ $\hbar = h/2\pi$ $hc = 1240 \text{ eV} \cdot \text{nm}$
Vacuum permittivity	$\epsilon_0 = 8.85 \times 10^{-12} \text{ C}^2/(\text{N} \cdot \text{m}^2)$
Vacuum permeability	$\mu_0 = 4\pi \times 10^{-7} \text{ T} \cdot \text{m/A}$
Universal gravitational constant	$G = 6.67 \times 10^{-11} \text{ m}^3/(\text{kg} \cdot \text{s}^2)$
Acceleration due to gravity	$g = 9.80 \text{ m/s}^2$
1 atmosphere pressure	$1 \text{ atm} = 1.0 \times 10^5 \text{ N/m}^2 = 1.0 \times 10^5 \text{ Pa}$
1 angstrom	$1 \text{ \AA} = 1 \times 10^{-10} \text{ m} = 0.1 \text{ nm}$

Prefixes for Powers of 10

$10^{-15}$	femto	f
$10^{-12}$	pico	p
$10^{-9}$	nano	n
$10^{-6}$	micro	$\mu$
$10^{-3}$	milli	m
$10^{-2}$	centi	c
$10^3$	kilo	k
$10^6$	mega	M
$10^9$	giga	G
$10^{12}$	tera	T
$10^{15}$	peta	P

Rotational inertia about center of mass

Rod	$\frac{1}{12} M\ell^2$
Disc	$\frac{1}{2} MR^2$
Sphere	$\frac{2}{5} MR^2$



This test starts on page 10.

**PHYSICS TEST**

**Time—170 minutes**

**100 Questions**

**Directions:** Each of the questions or incomplete statements below is followed by five suggested answers or completions. Select the one that is best in each case and then fill in the corresponding space on the answer sheet.

1. A net force  $F_A$  acts on object  $A$ , and a net force  $F_B$  acts on object  $B$ . The mass of object  $B$  is twice the mass of object  $A$ , and the acceleration of object  $B$  is twice that of object  $A$ . Which of the following is true of forces  $F_A$  and  $F_B$  ?

- (A)  $F_B = \frac{1}{4}F_A$
- (B)  $F_B = \frac{1}{2}F_A$
- (C)  $F_B = F_A$
- (D)  $F_B = 2F_A$
- (E)  $F_B = 4F_A$

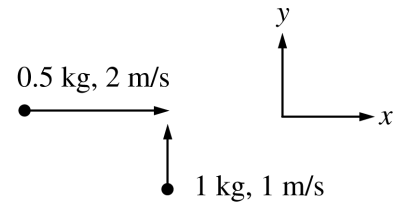

2. Two objects sliding on a frictionless surface, as represented above, collide and stick together. How much kinetic energy is converted to heat during the collision?
- (A)  $\frac{1}{9}$  J
  - (B)  $\frac{1}{6}$  J
  - (C)  $\frac{1}{2}$  J
  - (D)  $\frac{3}{4}$  J
  - (E)  $\frac{5}{6}$  J

**GO ON TO THE NEXT PAGE.**

## SCRATCH WORK

3. Two simple pendulums  $A$  and  $B$  consist of identical masses suspended from strings of length  $L_A$  and  $L_B$ , respectively. The two pendulums oscillate in equal gravitational fields. If the period of pendulum  $B$  is twice the period of pendulum  $A$ , which of the following is true of the lengths of the two pendulums?

- (A)  $L_B = \frac{1}{4}L_A$   
 (B)  $L_B = \frac{1}{2}L_A$   
 (C)  $L_B = L_A$   
 (D)  $L_B = 2L_A$   
 (E)  $L_B = 4L_A$

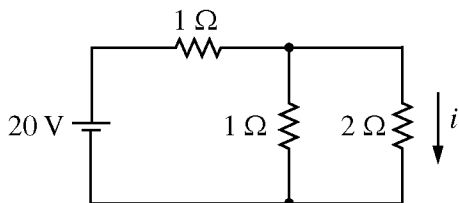

4. For the circuit shown in the figure above, what is the current  $i$  through the  $2\ \Omega$  resistor?

- (A) 2 A  
 (B) 4 A  
 (C) 5 A  
 (D) 10 A  
 (E) 20 A

5. By definition, the electric displacement current through a surface  $S$  is proportional to the

- (A) magnetic flux through  $S$   
 (B) rate of change of the magnetic flux through  $S$   
 (C) time integral of the magnetic flux through  $S$   
 (D) electric flux through  $S$   
 (E) rate of change of the electric flux through  $S$

6. The electric field of a plane electromagnetic wave of wave number  $k$  and angular frequency  $\omega$  is given by  $\mathbf{E} = E_0(\mathbf{e}_x + \mathbf{e}_y) \sin(kz - \omega t)$ . Which of the following gives the direction of the associated magnetic field  $\mathbf{B}$ ?

- (A)  $\mathbf{e}_z$   
 (B)  $-\mathbf{e}_x + \mathbf{e}_y$   
 (C)  $-\mathbf{e}_x - \mathbf{e}_y$   
 (D)  $\mathbf{e}_x - \mathbf{e}_z$   
 (E)  $\mathbf{e}_y - \mathbf{e}_z$

7. Which of the following is true about any system that undergoes a reversible thermodynamic process?

- (A) There are no changes in the internal energy of the system.  
 (B) The temperature of the system remains constant during the process.  
 (C) The entropy of the system and its environment remains unchanged.  
 (D) The entropy of the system and its environment must increase.  
 (E) The net work done by the system is zero.

8. For which of the following thermodynamic processes is the increase in the internal energy of an ideal gas equal to the heat added to the gas?

- (A) Constant temperature  
 (B) Constant volume  
 (C) Constant pressure  
 (D) Adiabatic  
 (E) Cyclic

GO ON TO THE NEXT PAGE.

## SCRATCH WORK

9. The root-mean-square speed of molecules in an ideal gas of molar mass  $M$  at temperature  $T$  is
- (A) 0
- (B)  $\sqrt{\frac{RT}{M}}$
- (C)  $\frac{RT}{M}$
- (D)  $\sqrt{\frac{3RT}{M}}$
- (E)  $\frac{3RT}{M}$
10. Light of variable frequency  $\nu$  shines on the metal surface of a photoelectric tube. Einstein's theory of the photoelectric effect predicts that the
- (A) work function of the metal is proportional to the frequency
- (B) work function of the metal is proportional to the wavelength
- (C) current in the tube is a linear function of the wavelength
- (D) potential difference necessary to stop the emitted electrons is a linear function of the frequency above the threshold frequency
- (E) potential difference necessary to stop the emitted electrons is equal to the work function
11. Characteristic X rays, appearing as sharp lines on a continuous background, are produced when high-energy electrons bombard a metal target. Which of the following processes results in the characteristic X rays?
- (A) Electrons producing Čerenkov radiation
- (B) Electrons colliding with phonons in the metal
- (C) Electrons filling inner shell vacancies that are created in the metal atoms
- (D) Electrons combining with protons to form neutrons
- (E) Electrons undergoing Coulomb scattering with nuclei
12. A single-electron atom has the electron in the  $\ell = 2$  state. The number of allowed values of the quantum number  $m_\ell$  is
- (A) 1
- (B) 2
- (C) 3
- (D) 4
- (E) 5
13. A particle of mass  $m$  is confined inside a one-dimensional box (infinite square well) of length  $a$ . The particle's ground state energy is which of the following?
- (A)  $\frac{\hbar}{8ma}$
- (B)  $\frac{\hbar^2}{8ma^2}$
- (C)  $\frac{\hbar^2}{ma^2}$
- (D)  $\frac{\hbar^2\pi^2}{2ma^2}$
- (E)  $\frac{\hbar^2a^2}{2mc^2}$
14. The Planck length is the only combination of the factors  $G$  (Newton's gravitational constant),  $\hbar$  (Planck's constant /  $2\pi$ ), and  $c$  (the speed of light) that has units of length. Which of the following gives the Planck length?
- (A)  $\left(\frac{\hbar G}{c^3}\right)^{1/2}$
- (B)  $\frac{\hbar G}{c^3}$
- (C)  $\frac{G^2}{\hbar c}$
- (D)  $\hbar c G$
- (E)  $\frac{\hbar G}{c}$

GO ON TO THE NEXT PAGE.

## SCRATCH WORK

15. The speed of light inside of a nonmagnetic dielectric material with a dielectric constant of 4.0 is
- (A)  $1.2 \times 10^9$  m/s  
 (B)  $3.0 \times 10^8$  m/s  
 (C)  $1.5 \times 10^8$  m/s  
 (D)  $1.0 \times 10^8$  m/s  
 (E)  $7.5 \times 10^7$  m/s
16. Fermat's principle of ray optics states, "A ray of light follows the path between two points which requires the least time." This principle can be used to derive which of the following?
- I. Snell's law of refraction  
 II. The law of reflection  
 III. Rayleigh's criterion for resolution
- (A) I only  
 (B) II only  
 (C) III only  
 (D) I and II  
 (E) II and III
17. Consider two identical systems, 1 and 2, each consisting of a planet in circular orbit about a much heavier star. For system 1 the radius of the orbit is  $a$ , and for system 2 the radius of the orbit is  $4a$ . Which of the following gives the ratio,  $\frac{T_1}{T_2}$ , of the period of system 1 to the period of system 2?
- (A)  $\frac{T_1}{T_2} = 1$   
 (B)  $\frac{T_1}{T_2} = \frac{1}{2}$   
 (C)  $\frac{T_1}{T_2} = \frac{1}{4}$   
 (D)  $\frac{T_1}{T_2} = \frac{1}{8}$   
 (E)  $\frac{T_1}{T_2} = \frac{1}{16}$
18. Two identical satellites,  $A$  and  $B$ , are in circular orbits around Earth. The orbital radius of  $A$  is twice that of  $B$ . Which of the following gives the ratio of the angular momentum of  $A$  to the angular momentum of  $B$ ?
- (A) 4  
 (B) 2  
 (C)  $\sqrt{2}$   
 (D)  $\frac{1}{\sqrt{2}}$   
 (E)  $\frac{1}{2}$
19. A 10 kg box slides horizontally without friction at a speed of 1 m/s. At one point, a constant force is applied to the box in the direction of its motion. The box travels 5 m with the constant force applied. The force is then removed, leaving the box with a speed of 2 m/s. Which of the following gives the magnitude of the applied force?
- (A) 1 N  
 (B) 2 N  
 (C) 3 N  
 (D) 4 N  
 (E) 5 N
20. What is the magnitude of the magnetic field at the center of a circular conducting loop of radius  $a$  that is carrying current  $I$ ?
- (A)  $4\pi\mu_0 I a^2$   
 (B)  $\mu_0 I a$   
 (C) 0  
 (D)  $\frac{\mu_0 I}{2a}$   
 (E)  $\frac{\mu_0 I}{4\pi a^2}$

GO ON TO THE NEXT PAGE.



## SCRATCH WORK

21. Let  $\omega_p$ ,  $\omega_d$ , and  $\omega_\alpha$  be the cyclotron frequencies of protons, deuterons, and alpha particles, respectively, in the same magnetic field. The frequencies are related by which of the following? (Assume that the particle masses are in the ratio 1 : 2 : 4.)
- (A)  $\omega_p = \omega_d = \omega_\alpha$   
 (B)  $\omega_p = \omega_d > \omega_\alpha$   
 (C)  $\omega_p = \omega_d < \omega_\alpha$   
 (D)  $\omega_p < \omega_d = \omega_\alpha$   
 (E)  $\omega_p > \omega_d = \omega_\alpha$
22. The emission spectrum of the doubly ionized lithium atom  $\text{Li}^{++}$  ( $Z = 3$ ,  $A = 7$ ) is identical to that of a hydrogen atom in which all the wavelengths are
- (A) decreased by a factor of 9  
 (B) decreased by a factor of 49  
 (C) decreased by a factor of 81  
 (D) increased by a factor of 9  
 (E) increased by a factor of 81
23. In an atom of hydrogen, the electron is bound to a proton. In an atom of positronium, the electron is bound to a positron instead of a proton. Which of the following gives the approximate Rydberg constant for positronium? (For a nucleus of infinite mass,  $R_\infty = \frac{m_e e^4}{8\epsilon_0^2 c h^3}$ .)
- (A)  $0.0005R_\infty$   
 (B)  $0.5R_\infty$   
 (C)  $0.999R_\infty$   
 (D)  $2R_\infty$   
 (E)  $1880R_\infty$
24. Which of the following gives the total spin quantum number of the electrons in the ground state of neutral nitrogen ( $Z = 7$ )?
- (A)  $\frac{1}{2}$   
 (B) 1  
 (C)  $\frac{3}{2}$   
 (D)  $\frac{5}{2}$   
 (E)  $\frac{7}{2}$
25. Consider a Hermitian operator  $\hat{A}$  with the property  $\hat{A}^4 = 1$ . Which of the following is an allowed pair of eigenvalues of  $\hat{A}$ ?
- (A) 0, 1  
 (B) 1, -1  
 (C) 1,  $i$   
 (D) 1,  $-i$   
 (E)  $1 + i$ ,  $1 - i$

$$\hat{T} \equiv \frac{\hat{p}^2}{2m}$$

$$\hat{H} \equiv \frac{\hat{p}^2}{2m} + V(\hat{x})$$

26. Consider the kinetic energy operator  $\hat{T}$  and the Hamiltonian operator  $\hat{H}$  above. Which of the following pairs of observables can be measured simultaneously with no restriction on their precision?
- (A)  $\hat{x}$  and  $\hat{p}$   
 (B)  $\hat{x}$  and  $\hat{T}$   
 (C)  $\hat{H}$  and  $\hat{p}$   
 (D)  $\hat{H}$  and  $\hat{T}$   
 (E)  $\hat{T}$  and  $\hat{p}$

GO ON TO THE NEXT PAGE.

## SCRATCH WORK

27. Electromagnetic radiation emitted from a nucleus is most likely to be in the form of

- (A) gamma rays
  - (B) microwaves
  - (C) ultraviolet radiation
  - (D) visible light
  - (E) infrared radiation
- 

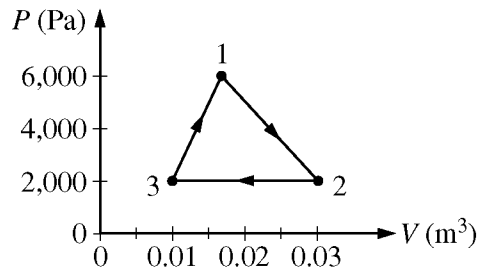

28. A sample of nitrogen gas undergoes the cyclic thermodynamic process shown above. Which of the following gives the net heat transferred to the system in one complete cycle  $1 \rightarrow 2 \rightarrow 3 \rightarrow 1$ ?

- (A)  $-80$  J
- (B)  $-40$  J
- (C)  $40$  J
- (D)  $80$  J
- (E)  $180$  J

GO ON TO THE NEXT PAGE.

## SCRATCH WORK

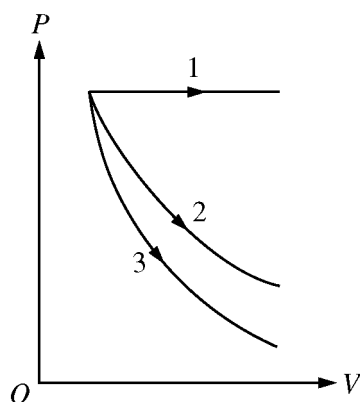

29. For an ideal gas, consider the three thermodynamic processes—labeled 1, 2, and 3—shown in the  $PV$  diagram above. Each process has the same initial state and the same final volume. One process is adiabatic, one is isobaric, and one is isothermal. Which of the following correctly identifies the three processes?

	<u>Adiabatic</u>	<u>Isobaric</u>	<u>Isothermal</u>
(A)	1	2	3
(B)	2	1	3
(C)	2	3	1
(D)	3	1	2
(E)	3	2	1

GO ON TO THE NEXT PAGE.

## SCRATCH WORK

30. The driver of a police car hears an echo of the car's siren from a wall toward which the car is moving with a speed of 3.5 m/s. If the speed of sound is 350 m/s and the frequency of the siren is 600 Hz, the driver hears the echo at a frequency nearest to which of the following?
- (A) 588 Hz  
 (B) 594 Hz  
 (C) 600 Hz  
 (D) 606 Hz  
 (E) 612 Hz
31. The first five harmonics produced by an organ pipe open at both ends are 50 Hz, 100 Hz, 150 Hz, 200 Hz, and 250 Hz. Which of the harmonics, if any, will survive once the pipe is closed at one end?
- (A) 50 Hz, 150 Hz, and 250 Hz only  
 (B) 100 Hz and 200 Hz only  
 (C) 150 Hz and 250 Hz only  
 (D) 200 Hz only  
 (E) None
32. A refracting telescope consists of two converging lenses separated by 100 cm. The eye-piece lens has a focal length of 20 cm. The angular magnification of the telescope is
- (A) 4  
 (B) 5  
 (C) 6  
 (D) 20  
 (E) 100
33. The best type of laser with which to do spectroscopy over a range of visible wavelengths is
- (A) a dye laser  
 (B) a helium-neon laser  
 (C) an excimer laser  
 (D) a ruby laser  
 (E) a neodymium-YAG laser
34. A rod measures 1.00 m in its rest system. How fast must an observer move parallel to the rod to measure its length to be 0.80 m?
- (A)  $0.50c$   
 (B)  $0.60c$   
 (C)  $0.70c$   
 (D)  $0.80c$   
 (E)  $0.90c$
35. A particle decays in  $2.0 \mu\text{s}$  in its rest frame. If the same particle moves at  $v = 0.60c$  in the lab frame, how far will it travel in the lab before decaying?
- (A) 150 m  
 (B) 288 m  
 (C) 360 m  
 (D) 450 m  
 (E) 750 m
36. The rest mass of a particle with total energy 5.0 GeV and momentum  $4.9 \text{ GeV}/c$  is approximately
- (A)  $0.1 \text{ GeV}/c^2$   
 (B)  $0.2 \text{ GeV}/c^2$   
 (C)  $0.5 \text{ GeV}/c^2$   
 (D)  $1.0 \text{ GeV}/c^2$   
 (E)  $1.5 \text{ GeV}/c^2$
37. If charge  $+Q$  is located in space at the point  $(x = 1 \text{ m}, y = 10 \text{ m}, z = 5 \text{ m})$ , what is the total electric flux that passes through the  $yz$ -plane?
- (A)  $\infty$   
 (B) 1  
 (C)  $\frac{Q}{\epsilon_0}$   
 (D)  $\frac{Q}{2\epsilon_0}$   
 (E) 0

GO ON TO THE NEXT PAGE.



## SCRATCH WORK

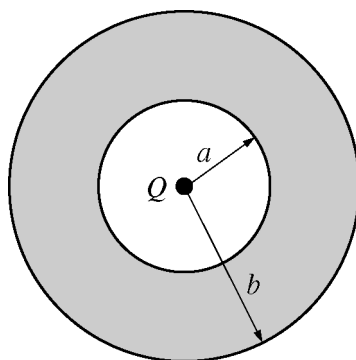

38. A point charge  $Q$  is placed at the center of a hollow, conducting spherical shell of inner radius  $a$  and outer radius  $b$ , as shown above. A net charge  $q$  is placed on the conducting shell. If the electric potential is assumed to be 0 at infinity, the magnitude of the electric potential at  $r$ , where  $a < r < b$ , is

(A) 0

(B)  $\frac{Q}{4\pi\epsilon_0 r}$

(C)  $\frac{Q + q}{4\pi\epsilon_0 r}$

(D)  $\frac{Q}{4\pi\epsilon_0 a}$

(E)  $\frac{Q + q}{4\pi\epsilon_0 b}$

GO ON TO THE NEXT PAGE.

## SCRATCH WORK

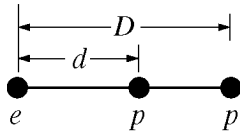

(1)

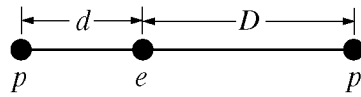

(2)

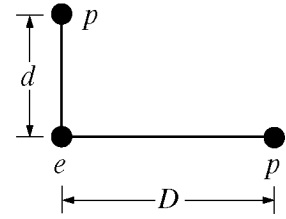

(3)

39. The figure above shows three arrangements of one electron ( $e$ ) and two protons ( $p$ ). Which of the following is true about the magnitude  $F$  of the net electrostatic force acting on the electron due to the protons?

- (A)  $F_1 > F_2 > F_3$
- (B)  $F_1 = F_2 > F_3$
- (C)  $F_1 > F_3 > F_2$
- (D)  $F_2 > F_1 > F_3$
- (E)  $F_2 > F_3 > F_1$

## SCRATCH WORK

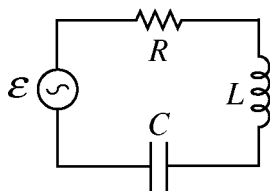

40. A series AC circuit with impedance  $Z$  consists of resistor  $R$ , inductor  $L$ , and capacitor  $C$ , as shown above. The ideal emf source has a sinusoidal output given by  $\mathcal{E} = \mathcal{E}_{\max} \sin \omega t$ , and the current is given by  $I = I_{\max} \sin(\omega t - \phi)$ . What is the average power dissipated in the circuit? ( $I_{rms}$  is the root-mean-square current.)

- (A)  $I_{rms}^2 R$
- (B)  $\frac{1}{2} I_{rms}^2 R$
- (C)  $\frac{1}{2} I_{rms}^2 Z$
- (D)  $\frac{1}{2} I_{rms}^2 R \cos \phi$
- (E)  $\frac{1}{2} I_{rms}^2 Z \cos \phi$

GO ON TO THE NEXT PAGE.

## SCRATCH WORK

41. The quantum efficiency of a photon detector is 0.1.  
If 100 photons are sent into the detector, one after the other, the detector will detect photons
- (A) exactly 10 times
  - (B) an average of 10 times, with an rms deviation of about 0.1
  - (C) an average of 10 times, with an rms deviation of about 1
  - (D) an average of 10 times, with an rms deviation of about 2
  - (E) an average of 10 times, with an rms deviation of about 3

**GO ON TO THE NEXT PAGE.**



## SCRATCH WORK

42. Two students perform an experiment in which they drop a ball from rest from a known height above the ground and measure the speed of the ball just before it strikes the ground. From repeated measurement, the students estimate the uncertainty in the measured speed of the ball to be 10 percent. Which of the following gives the uncertainty in the kinetic energy of the ball? (Assume the uncertainty in the ball's mass is negligibly small.)

- (A) 5%
- (B) 10%
- (C) 15%
- (D) 20%
- (E) 40%

43. Which of the following wave functions represents a solution to the Schrödinger equation for an electron in the  $2s$  state of a hydrogen atom? ( $c$  is a constant and  $a_0$  is the Bohr radius.)

- (A)  $c \cos \theta$
- (B)  $c \exp\left(-\frac{r}{a_0}\right)$
- (C)  $c \left(1 - \frac{r}{2a_0}\right) \exp\left(-\frac{r}{2a_0}\right)$
- (D)  $c \left(1 - \frac{r}{2a_0}\right) \exp\left(-\frac{r}{2a_0}\right) \cos \theta$
- (E)  $c \left(1 - \frac{r}{2a_0}\right) \exp\left(-\frac{r}{2a_0}\right) \sin \theta \exp(\pm i \phi)$

44. A particle in an infinite square well has as its initial wave function an equal mixture of the first three orthonormal stationary states:  $\Psi(x,0) = A[\psi_1(x) + \psi_2(x) + \psi_3(x)]$ . The value of the normalization constant  $A$  is equal to which of the following?

- (A)  $\frac{1}{\sqrt{3}}$
- (B)  $\frac{1}{\sqrt{2}}$
- (C) 1
- (D)  $\sqrt{2}$
- (E)  $\sqrt{3}$

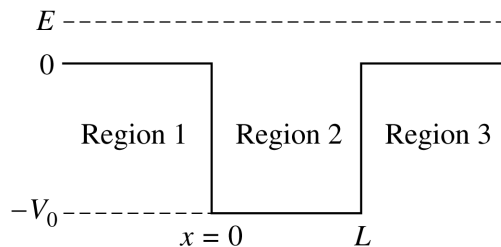

45. A matter wave of energy  $E > 0$  and wave number  $k$  is incident from the left on a potential well of width  $L$  and depth  $V_0$ . The top of the well is at zero energy and the bottom of the well is at  $-V_0$ , as shown in the figure above. The spatial part of the wave function in region 3 has which of the following forms? ( $A$  is a constant.)

- (A)  $Ae^{ikx}$
- (B)  $A \sin kx$
- (C)  $A \cos kx$
- (D)  $Ae^{ik'x}$  ( $k' < k$ )
- (E)  $Ae^{-\kappa x}$  ( $\kappa$  real and positive)

GO ON TO THE NEXT PAGE.

## SCRATCH WORK

46. Spring 1 has force constant  $k_1$  and spring 2 has force constant  $k_2$ , where  $k_1 > k_2$ . If the same external force is applied to both springs, which of the following is true about the extensions ( $\Delta x_1$  and  $\Delta x_2$ ) and the stored potential energies ( $U_1$  and  $U_2$ ) of the two springs?

<u>Extension</u>	<u>Stored Potential Energy</u>
(A) $\Delta x_1 < \Delta x_2$	$U_1 < U_2$
(B) $\Delta x_1 < \Delta x_2$	$U_1 > U_2$
(C) $\Delta x_1 = \Delta x_2$	$U_1 < U_2$
(D) $\Delta x_1 = \Delta x_2$	$U_1 = U_2$
(E) $\Delta x_1 > \Delta x_2$	$U_1 = U_2$

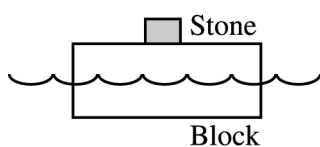

Figure 1



Figure 2

47. A stone is glued to the top of a light wooden block that floats in a pool of water, as shown in Figure 1 above. Assume that exactly 50 percent of the block is under water, and that the stone has half the weight of the block. If the block and stone are flipped over, as shown in Figure 2, and replaced in the pool, the amount of the block under water will be
- (A) less than 50%  
 (B) still 50%  
 (C) between 50% and 75%  
 (D) between 75% and 100%  
 (E) 100%, since the stone and block sink

48. A uniform solid disk starts from rest and rolls down an inclined plane without slipping. After some time, what fraction of the disk's total kinetic energy is rotational kinetic energy?

- (A)  $\frac{1}{4}$   
 (B)  $\frac{1}{3}$   
 (C)  $\frac{1}{2}$   
 (D)  $\frac{2}{3}$   
 (E)  $\frac{3}{4}$

49. Two projectiles are launched from ground level with the same initial speed. The maximum height  $h_1$  reached by projectile 1 is twice the maximum height  $h_2$  reached by projectile 2. If  $\theta_1$  and  $\theta_2$  denote the respective launch angles, as measured from the horizontal, these angles satisfy which of the following relationships?

- (A)  $\cos \theta_1 = \sqrt{2} \cos \theta_2$   
 (B)  $\sin \theta_1 = \sqrt{2} \sin \theta_2$   
 (C)  $\tan \theta_1 = \sqrt{2} \tan \theta_2$   
 (D)  $\sin \theta_1 = 2 \sin \theta_2$   
 (E)  $\cos \theta_1 = 2 \cos \theta_2$

GO ON TO THE NEXT PAGE.

## SCRATCH WORK

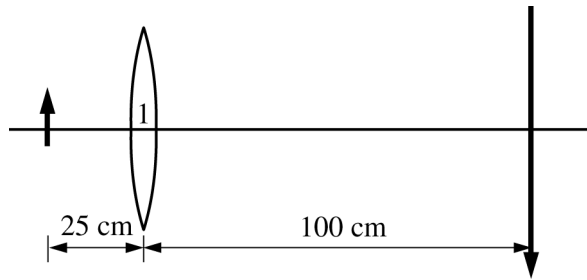

Figure 1

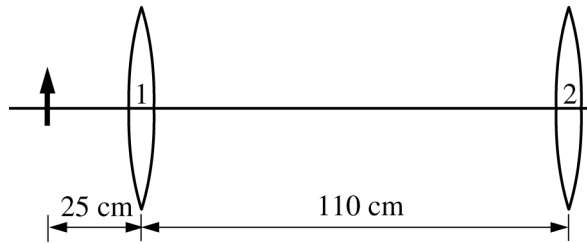

Figure 2

50. When an object is located 25 cm from lens 1, an inverted image is produced 100 cm from the lens, as shown in Figure 1 above. A second lens with a focal length of +20 cm is placed 110 cm from the first lens, as shown in Figure 2 above. Which of the following is true of the image produced by lens 2 ?
- (A) It is real and inverted relative to the object.
  - (B) It is real and upright relative to the object.
  - (C) It is virtual and inverted relative to the object.
  - (D) It is virtual and upright relative to the object.
  - (E) An image cannot be produced in this situation.

GO ON TO THE NEXT PAGE.

## SCRATCH WORK

51. A grating spectrometer can just barely resolve two wavelengths of 500 nm and 502 nm, respectively. Which of the following gives the resolving power of the spectrometer?
- (A) 2
  - (B) 250
  - (C) 5,000
  - (D) 10,000
  - (E) 250,000
52. A gas cell with an optical path length of 10 cm is placed in one arm of a Michelson interferometer. If the light source for the interferometer is a laser with wavelength  $\lambda = 632.2$  nm, then 100 fringes are counted as the gas cell is evacuated. What is the index of refraction of the original gas?
- (A) 1.00063
  - (B) 1.00032
  - (C) 1.00016
  - (D) 0.99968
  - (E) -1.00016
53. A microwave line has a laboratory wavelength of 1  $\mu\text{m}$ . If the Hubble constant  $H \approx 75$  (km/s)/Mpc, the observed wavelength for the line from a galaxy 100 Mpc distant is about
- (A) 250 nm shorter
  - (B) 25 nm shorter
  - (C) the same
  - (D) 25 nm longer
  - (E) 250 nm longer

**GO ON TO THE NEXT PAGE.**



## SCRATCH WORK

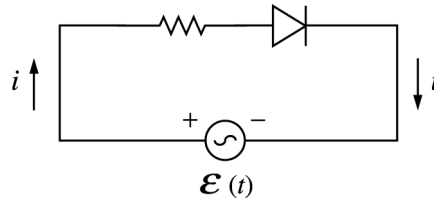

54. The AC circuit shown above contains an ideal rectifying diode. If the function generator supplies  $\mathcal{E}(t) = V_0 \sin \omega t$ , which of the following describes the voltage across the resistor?

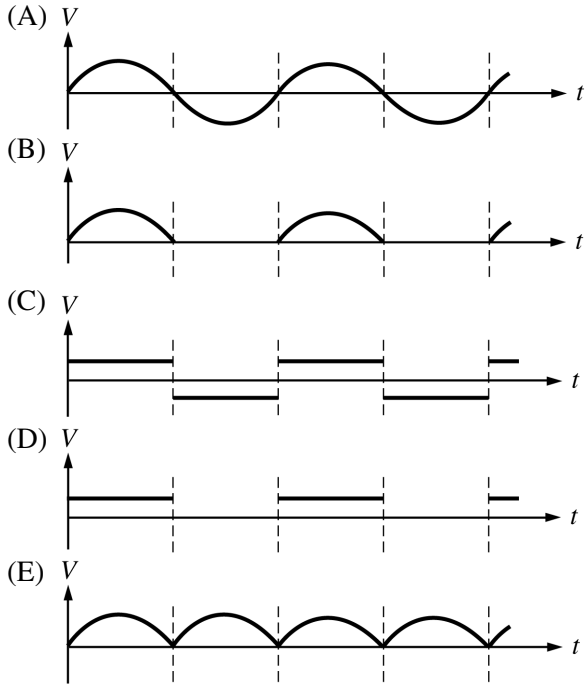

GO ON TO THE NEXT PAGE.

## SCRATCH WORK

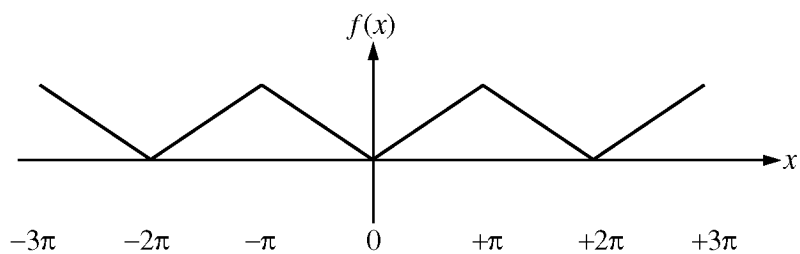

55. The Fourier series expansion of a function  $f(x)$  that is periodic with period  $2\pi$  is

$$f(x) = \frac{a_0}{2} + \sum_{n=1}^{\infty} a_n \cos(nx) + \sum_{n=1}^{\infty} b_n \sin(nx).$$

If  $f(x)$  is given by the graph above, which of the following statements about the coefficients is true?

- (A)  $a_n = 0$  for all  $n$
- (B)  $b_n = 0$  for all  $n$
- (C)  $a_n = 0$  for even  $n$  only
- (D)  $b_n = 0$  for even  $n$  only
- (E)  $a_n = b_n$  for all  $n$

GO ON TO THE NEXT PAGE.

## SCRATCH WORK

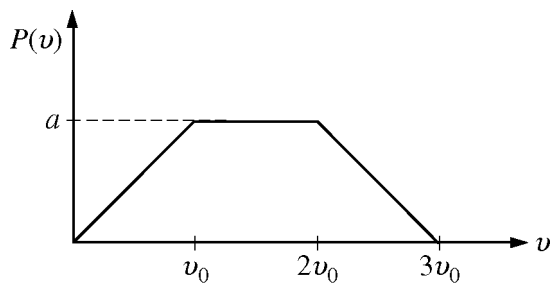

56. A sample of  $N$  molecules has the distribution of speeds shown in the figure above.  $P(v)dv$  is an estimate of the number of molecules with speeds between  $v$  and  $v + dv$ , and this number is nonzero only up to  $3v_0$ , where  $v_0$  is constant. Which of the following gives the value of  $a$ ?

- (A)  $a = \frac{N}{3v_0}$   
 (B)  $a = \frac{N}{2v_0}$   
 (C)  $a = \frac{N}{v_0}$   
 (D)  $a = \frac{3N}{2v_0}$   
 (E)  $a = N$

57. Which of the following statements is (are) true for a Maxwell-Boltzmann description of an ideal gas of atoms in equilibrium at temperature  $T$ ?

- I. The average velocity of the atoms is zero.  
 II. The distribution of the speeds of the atoms has a maximum at  $v = 0$ .  
 III. The probability of finding an atom with zero kinetic energy is zero.

- (A) I only  
 (B) II only  
 (C) I and II  
 (D) I and III  
 (E) II and III

58. A monatomic ideal gas changes from an initial state  $(P_i, V_i, T_i, n_i)$  to a final state  $(P_f, V_f, T_f, n_f)$ , where  $P_i < P_f$ ,  $V_i = V_f$ ,  $T_i < T_f$  and  $n_i = n_f$ . Which of the following gives the change in entropy of the gas?

- (A)  $\frac{3}{2}nR \ln\left(\frac{T_f}{T_i}\right)$   
 (B)  $\frac{3}{2}nR \ln\left(\frac{T_i}{T_f}\right)$   
 (C)  $\frac{5}{2}nR \ln\left(\frac{T_f}{T_i}\right)$   
 (D)  $\frac{5}{2}nR \ln\left(\frac{T_i}{T_f}\right)$   
 (E) 0

GO ON TO THE NEXT PAGE.

## SCRATCH WORK

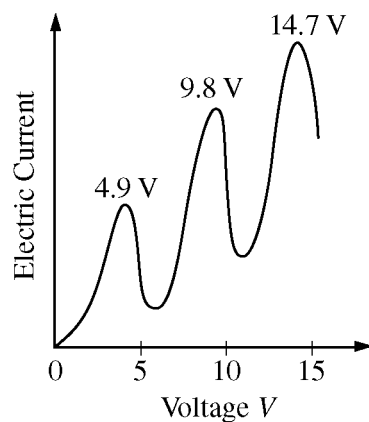
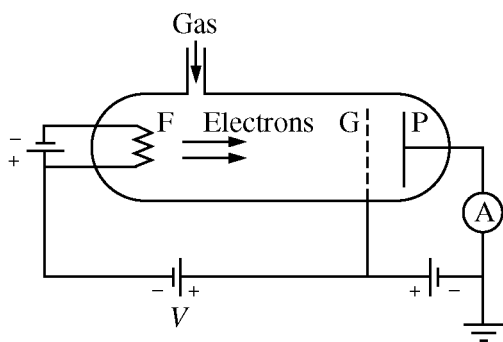

59. Low-energy electrons are accelerated between electrodes in a tube filled with a gas in the Franck-Hertz apparatus represented above. A plot of current collected versus accelerating voltage is also shown. The data provide evidence for which of the following?
- (A) Electronic energy losses due only to elastic collisions
  - (B) Excitation energies of the gas atoms of 4.9, 9.8, and 14.7 eV
  - (C) Excitation energy of the gas atoms of 4.9 eV only
  - (D) Atomic energy levels of  $-4.9$ ,  $-9.8$ , and  $-14.7$  eV
  - (E) Atomic energy levels of  $-4.9$  and  $-9.8$  eV only

GO ON TO THE NEXT PAGE.



## SCRATCH WORK

60. A photon of wavelength  $\lambda$  is scattered from an electron through an angle  $\theta$ . Which of the following correctly gives the wavelength  $\lambda'$  of the scattered photon?
- (A)  $\lambda' = \lambda + \frac{h}{mc}(1 - \cos\theta)$   
 (B)  $\lambda' = \lambda + \frac{h}{mc}(1 + \cos\theta)$   
 (C)  $\lambda' = \lambda - \frac{h}{mc}(1 - \cos\theta)$   
 (D)  $\lambda' = \lambda - \frac{h}{mc}(1 + \cos\theta)$   
 (E)  $\lambda' = \frac{h}{mc}(1 - \cos\theta)$
61. Excited states of the helium atom can be characterized as para- (antiparallel electron spins) and ortho- (parallel electron spins). The observation that an ortho- state has lower energy than the corresponding para- state can be understood in terms of which of the following?
- (A) The Heisenberg uncertainty principle  
 (B) The Pauli exclusion principle  
 (C) The Bohr model of the atom  
 (D) Nuclear hyperfine coupling  
 (E) Maxwell-Boltzmann statistics
62. A particle of mass  $m$  and spin zero is in a three-dimensional isotropic well described by  $V(r) = \frac{1}{2}m\omega^2r^2$ , where  $r^2 = x^2 + y^2 + z^2$ . How many states have energy  $\frac{7}{2}\hbar\omega$  ?
- (A) 1  
 (B) 2  
 (C) 4  
 (D) 6  
 (E) 8
63. The operators for the total angular momentum and its three projections are  $\hat{\mathbf{J}}$  and  $\hat{J}_x, \hat{J}_y, \hat{J}_z$ , respectively. The commutator between two operators  $\hat{A}$  and  $\hat{B}$  is  $[\hat{A}, \hat{B}] \equiv \hat{A}\hat{B} - \hat{B}\hat{A}$ . Which of the following is true?
- (A)  $[\hat{\mathbf{J}}^2, \hat{J}_z] = 0$   
 (B)  $[\hat{\mathbf{J}}^2, \hat{J}_z] = i\hbar\hat{J}_y$   
 (C)  $[\hat{J}_x, \hat{J}_y] = 0$   
 (D)  $[\hat{J}_x, \hat{J}_z] = i\hbar\hat{J}_z$   
 (E)  $[\hat{J}_x + i\hat{J}_y, \hat{J}_z] = 0$
64. The suspension cable of a 1,000 kg elevator snaps, sending the elevator moving downward through its shaft. The emergency brakes of the elevator stop the elevator shortly before it reaches the bottom of the shaft. If the elevator fell a distance of 100 m starting from rest, the heat that the brakes must dissipate to bring the elevator safely to rest is
- (A) 100 J  
 (B) 1,000 J  
 (C) 10,000 J  
 (D) 100,000 J  
 (E) 1,000,000 J

GO ON TO THE NEXT PAGE.

## SCRATCH WORK

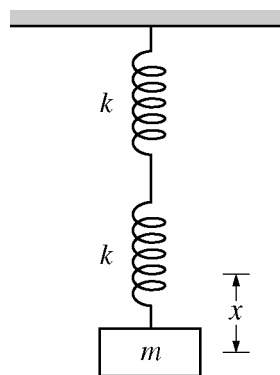
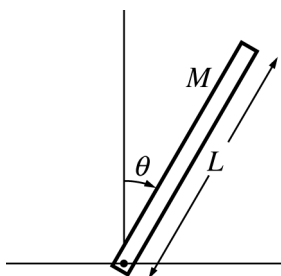

65. A uniform rod of length  $L$  and mass  $M$  is released from rest at  $\theta = 0$  and rotates about a horizontal axis through its base, as shown in the figure above. What is the angular acceleration of the rod as a function of  $\theta$ ? (Ignore the effects of friction and air resistance.)

- (A)  $\frac{g}{2L}$   
 (B)  $\frac{g}{L}\theta$   
 (C)  $\frac{6g}{L}\cos\theta$   
 (D)  $\frac{3g}{2L}\sin\theta$   
 (E)  $\frac{12g}{L}\sin\theta$

66. Two identical, ideal springs, each with force constant  $k$ , are attached in series and hung vertically. When a block of mass  $m$  is attached to the two-spring system, the block moves down a distance  $x$  from the relaxed state, as shown in the figure above. Which of the following gives the angular frequency of the block when it oscillates vertically?

- (A)  $\sqrt{\frac{2k}{m}}$   
 (B)  $\sqrt{\frac{k}{m}}$   
 (C)  $\sqrt{\frac{k}{2m}}$   
 (D)  $2\pi\sqrt{\frac{k}{x}}$   
 (E)  $2\pi\sqrt{\frac{2k}{x}}$

67. A block attached to a spring is moving along the  $x$ -axis on a frictionless horizontal surface. What is the Hamiltonian for the block?

- (A)  $H = 0$   
 (B)  $H = -kx$   
 (C)  $H = \frac{k}{2}x^2$   
 (D)  $H = \frac{p^2}{2m} - \frac{k}{2}x^2$   
 (E)  $H = \frac{p^2}{2m} + \frac{k}{2}x^2$

GO ON TO THE NEXT PAGE.

## SCRATCH WORK

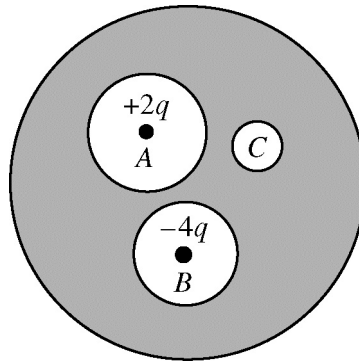

68. A conducting sphere is solid except for three spherical cavities inside. Cavity  $A$  contains a point charge of  $+2q$ , cavity  $B$  contains a point charge of  $-4q$ , and cavity  $C$  is empty, as shown above. What charges are induced on the inner surfaces of the spherical cavities?

	<u>Cavity A</u>	<u>Cavity B</u>	<u>Cavity C</u>
(A)	$-2q$	$+4q$	0
(B)	$-2q$	$+4q$	$-2q$
(C)	$-2q$	$+4q$	$-6q$
(D)	$+2q$	$-4q$	0
(E)	$+2q$	$+2q$	$+2q$

GO ON TO THE NEXT PAGE.

## SCRATCH WORK

69. A magnetic field is directed perpendicular to the plane of a circular coil of area  $0.2 \text{ m}^2$  and 250 turns. If the magnetic field is increased from  $0.01 \text{ T}$  to  $0.06 \text{ T}$  during a time interval of  $0.25 \text{ s}$ , the average induced EMF in the coil is

- (A)  $0.04 \text{ V}$
- (B)  $0.1 \text{ V}$
- (C)  $2.5 \text{ V}$
- (D)  $10 \text{ V}$
- (E)  $50 \text{ V}$

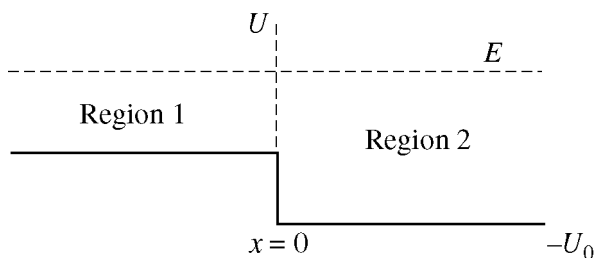

70. The figure above depicts a step potential with

$$U(x) = 0, \quad \text{for } x \leq 0 \quad (\text{region 1}),$$

$$U(x) = -U_0, \quad \text{for } x > 0 \quad (\text{region 2}).$$

A beam of particles with  $E > 0$  is incident from the left. The momentum of the particle in each region has the form  $\hbar k$ . The reflection coefficient  $R$  for the interface at  $x = 0$  is

- (A)  $R = 0$
- (B)  $R = \frac{4k_1k_2}{(k_1 + k_2)^2}$
- (C)  $R = \frac{(k_1 + k_2)^2}{(k_1 - k_2)^2}$
- (D)  $R = \frac{(k_1 - k_2)^2}{(k_1 + k_2)^2}$
- (E)  $R = \frac{-4k_1k_2}{(k_1 + k_2)^2}$

71. Consider the Pauli spin matrices  $\sigma_x$ ,  $\sigma_y$ , and  $\sigma_z$ . The product  $\sigma_x \sigma_y$  is equal to which of the following?

- (A)  $0$
- (B)  $\sigma_z$
- (C)  $-\sigma_z$
- (D)  $\sigma_y \sigma_x$
- (E)  $-\sigma_y \sigma_x$

72. The binding energy per nucleon is greatest for which of the following nuclei?

- (A)  ${}^3_2\text{He}$
- (B)  ${}^4_2\text{He}$
- (C)  ${}^{56}_{26}\text{Fe}$
- (D)  ${}^{235}_{92}\text{U}$
- (E)  ${}^{238}_{92}\text{U}$

73. The negative muon,  $\mu^-$ , has properties most similar to which of the following?

- (A) Quark
- (B) Boson
- (C) Photon
- (D) Meson
- (E) Electron

GO ON TO THE NEXT PAGE.



## SCRATCH WORK

74. Which of the following correctly gives the quark and antiquark content of a lepton and a baryon?

	<u>Lepton</u>		<u>Baryon</u>	
	<u>Quarks</u>	<u>Antiquarks</u>	<u>Quarks</u>	<u>Antiquarks</u>
(A)	0	0	3	0
(B)	0	0	1	1
(C)	1	0	1	1
(D)	1	1	2	0
(E)	1	1	3	0

**GO ON TO THE NEXT PAGE.**

## SCRATCH WORK

75. Under certain conditions, a beam of electrons impinging on a crystal surface will diffract and a scattering pattern of the beam can be obtained. What is the approximate kinetic energy of the electrons needed in order to see the pattern? (Assume the lattice spacing of the crystal to be 0.4 nm.)
- (A) 0.1 eV
  - (B) 1 eV
  - (C) 10 eV
  - (D) 100 eV
  - (E) 1000 eV

**GO ON TO THE NEXT PAGE.**

## SCRATCH WORK

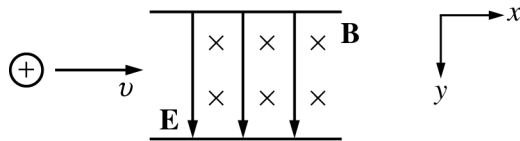

76. A beam of positive ions is initially moving in the  $+x$ -direction with nonrelativistic velocity. The beam enters a velocity selector in which the electric field  $\mathbf{E}$  is oriented along the  $+y$ -direction and the magnetic field  $\mathbf{B}$  is oriented along the  $+z$ -direction, as shown above. Which of the following gives the critical speed  $v_c$  at which the ion beam is not deflected as it moves through the velocity selector?

(A)  $v_c = EB$

(B)  $v_c = \frac{1}{EB}$

(C)  $v_c = \frac{B^2}{E}$

(D)  $v_c = \frac{B}{E}$

(E)  $v_c = \frac{E}{B}$

GO ON TO THE NEXT PAGE.

## SCRATCH WORK

77. Under ideal conditions, the electric and magnetic fields inside a superconductor are zero. Maxwell's equations imply that which of the following must be true just outside the surface of the superconductor?

- (A)  $\mathbf{B} = \mathbf{0}$
- (B)  $\mathbf{B}$  is perpendicular to the surface.
- (C)  $\mathbf{B}$  is tangential to the surface.
- (D)  $\mathbf{B}$  is time independent.
- (E) The magnetic flux is quantized.

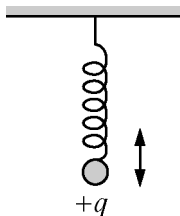

78. A positive charge,  $+q$ , oscillates up and down, as represented in the figure above. What is the direction of the Poynting vector  $\mathbf{S}$  at point  $P$ ? (Assume  $P$  is located far to the right of  $+q$ .)

- (A) Toward the left
- (B) Toward the right
- (C) Toward the top of the page
- (D) Toward the bottom of the page
- (E) Into the page

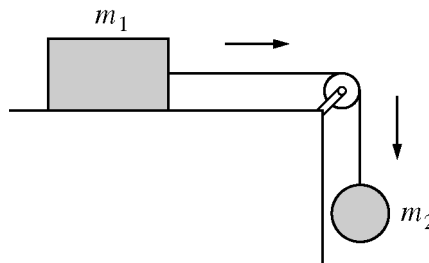

79. A block with mass  $m_1$  that slides on a frictionless table is attached by a massless string over a massless, frictionless pulley to a hanging ball with mass  $m_2$ , as shown in the figure above. The tension in the string must be

- (A) equal to  $m_2g$
- (B) greater than  $m_2g$
- (C) less than  $m_2g$
- (D) equal to  $m_1g$
- (E) greater than  $m_1g$

GO ON TO THE NEXT PAGE.



## SCRATCH WORK

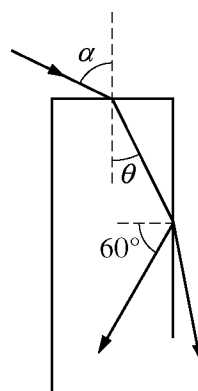
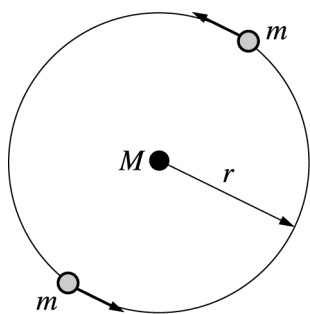

80. Two planets of mass  $m$  revolve around a star of mass  $M$  in a circle of radius  $r$ , as shown in the figure above. The two planets are always on opposite sides of the star. The orbital period  $T$  of the planets is of the form  $T = 2\pi\sqrt{\frac{r^3}{GM'}}$ .

What is the value of  $M'$ ?

- (A)  $M - \frac{m}{2}$   
 (B)  $M - \frac{m}{4}$   
 (C)  $M$   
 (D)  $M + \frac{m}{4}$   
 (E)  $M + \frac{m}{2}$
81. White light is normally incident on a puddle of water (index of refraction 1.33). A thin (500 nm) layer of oil (index of refraction 1.5) floats on the surface of the puddle. Of the following, the most strongly reflected wavelength is
- (A) 500 nm  
 (B) 550 nm  
 (C) 600 nm  
 (D) 650 nm  
 (E) 700 nm

82. As represented in the figure above, a light ray refracts from air into a rectangular block of plastic with an index of refraction  $n > 1$ . At a point on the side of the block, the ray partly reflects (at an angle of  $60^\circ$ ) and partly refracts. The value of the angle  $\alpha$  is

- (A)  $30^\circ$   
 (B)  $60^\circ$   
 (C)  $\cos^{-1} \frac{n}{2}$   
 (D)  $\sin^{-1} \frac{n}{2}$   
 (E)  $\tan^{-1} n$
83. Assume that the solar flux at Earth's surface is  $1,000 \text{ W/m}^2$  and that the sunlight is normal to a completely reflecting surface with an area of  $3 \text{ m}^2$ . What is the total radiation force exerted on the surface?
- (A)  $2 \times 10^{-6} \text{ N}$   
 (B)  $1 \times 10^{-5} \text{ N}$   
 (C)  $2 \times 10^{-5} \text{ N}$   
 (D)  $3 \text{ N}$   
 (E)  $6 \text{ N}$

GO ON TO THE NEXT PAGE.

## SCRATCH WORK

84. The hydrogen lines observed in the spectrum of the quasar 3C9 are shifted so far into the red that their wavelengths are three times as long as those observed in the light from hydrogen atoms at rest in a laboratory on Earth. If it is assumed that the shift is entirely due to the relative motion of 3C9 and Earth, the relative speed of the quasar is
- (A)  $2c$
  - (B)  $c$
  - (C)  $0.8c$
  - (D)  $0.5c$
  - (E)  $0.3c$
85. Protons used in cancer therapy are typically accelerated to about  $0.6c$ . How much work must be done on a particle of mass  $m$  in order for it to reach this speed, assuming it starts at rest?
- (A)  $0.25mc^2$
  - (B)  $0.60mc^2$
  - (C)  $0.67mc^2$
  - (D)  $1.25mc^2$
  - (E)  $1.60mc^2$
86. The sign of the charge carriers in a doped semiconductor can be deduced by measuring which of the following properties?
- (A) Specific heat
  - (B) Thermal conductivity
  - (C) Electrical resistivity
  - (D) Magnetic susceptibility
  - (E) Hall coefficient

**GO ON TO THE NEXT PAGE.**

## SCRATCH WORK

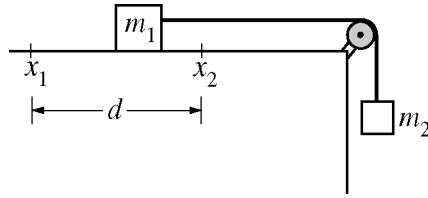

87. In the experimental setup above, two masses,  $m_1$  and  $m_2$ , are connected by a massless string over a massless pulley. Mass  $m_1$  slides on a frictionless surface. The values of the two masses can be measured, as well as the distance  $d$  and the speed of mass  $m_1$  as it passes  $x_1$  and again at  $x_2$ . The experiment can be used to do which of the following?
- I. Demonstrate momentum conservation
  - II. Demonstrate energy conservation
  - III. Measure the value of the acceleration due to gravity
- (A) I only  
(B) II only  
(C) III only  
(D) I and II  
(E) II and III

GO ON TO THE NEXT PAGE.

## SCRATCH WORK

88. An airplane drops a payload while traveling due north, parallel to the ground, at a constant speed of 100 m/s. If air resistance is neglected, what is the velocity of the payload relative to the plane 4.0 s after it is released?

- (A) 0
- (B) 40 m/s down
- (C) 80 m/s down
- (D) 100 m/s north and 40 m/s down
- (E) 100 m/s south and 40 m/s down

89. Two balls, identical in every way except that one has twice the mass of the other, are dropped from rest from the same height so that they both reach terminal speed before hitting the ground. If it is assumed that the drag force varies like the speed squared, what is the ratio of the terminal speeds of the balls? (Note: The subscripts  $h$  and  $l$  denote the heavy and light masses, respectively.)

- (A)  $\frac{v_h}{v_l} = 1$
- (B)  $\frac{v_h}{v_l} = \sqrt{2}$
- (C)  $\frac{v_h}{v_l} = 2$
- (D)  $\frac{v_h}{v_l} = 2\sqrt{2}$
- (E)  $\frac{v_h}{v_l} = 4$

**GO ON TO THE NEXT PAGE.**



## SCRATCH WORK

90. One end of a horizontal, massless spring is attached to a wall. A mass of 0.30 kg is attached to the other end of the spring and rests on a table. The mass is displaced 0.030 m from its equilibrium position and released. It has a speed of 0.040 m/s as it passes through its equilibrium position. In the absence of friction, what is the total mechanical energy of the system?
- (A) 0.24 mJ
  - (B) 0.38 mJ
  - (C) 0.48 mJ
  - (D) 0.75 mJ
  - (E) 0.96 mJ

**GO ON TO THE NEXT PAGE.**

## SCRATCH WORK

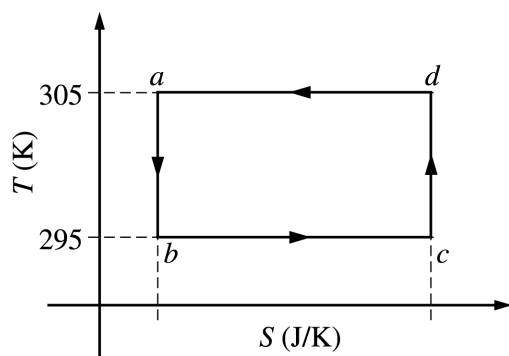

91. The diagram above shows a Carnot cycle for an ideal air conditioner, which is to cool a house on a hot summer day. The air conditioner absorbs heat at the lower temperature inside and pumps it to the environment at the higher temperature outside. Which of the following gives the ratio of the heat  $Q_{bc}$  absorbed in the house (i.e., between points  $b$  and  $c$  on the cycle) to the work done during the cycle?

- (A) 0
- (B) 0.033
- (C) 0.97
- (D) 1.0
- (E) 30.

92. A particle in an infinite square well with walls at  $x = 0$  and  $x = L$  has energy  $E = \frac{9\hbar^2\pi^2}{2mL^2}$ . The probability that the particle is between  $x = 0$  and  $x = L/6$  is

- (A) 1/36
- (B) 1/6
- (C) 1/3
- (D) 1/2
- (E) 1

93. An inertial reference frame  $S'$  moves at constant speed with respect to a second inertial reference frame  $S$ . An observer in  $S$  measures the energy  $E$ , momentum  $p$ , and position  $x$  of a moving particle at time  $t$  for a particular event. An observer in  $S'$  measures energy  $E'$ , momentum  $p'$ , and position  $x'$  at time  $t'$  for the same moving particle at the same event. Which of the following is an expression of a relativistic invariant for this event?

- (A)  $x = x'$
- (B)  $p = p'$
- (C)  $t = t'$
- (D)  $E = E'$
- (E)  $E^2 - (pc)^2 = E'^2 - (p'c)^2$

94. Consider three identical, ideal capacitors. The first capacitor is charged to a voltage  $V_0$  and then disconnected from the battery. The other two capacitors, initially uncharged and connected in series, are then connected across the first capacitor. What is the final voltage on the first capacitor?

- (A)  $\frac{V_0}{5}$
- (B)  $\frac{V_0}{3}$
- (C)  $\frac{V_0}{2}$
- (D)  $\frac{2V_0}{3}$
- (E)  $V_0$

GO ON TO THE NEXT PAGE.

## SCRATCH WORK

95. A charge of  $-5.0 \mu\text{C}$  is distributed uniformly around a ring 1.0 m in radius. A point charge of  $+3.0 \mu\text{C}$  is at the center of the ring. The work required to move the point charge 1.0 m in a direction normal to the plane of the ring is most nearly

- (A) 40 mJ
- (B) 80 mJ
- (C) 100 mJ
- (D) 140 mJ
- (E) 270 mJ

96. The magnetic field inside a long coil of wire (solenoid) has a certain magnitude and direction when the coil is air filled. If a diamagnetic material is inserted in the coil, how do the magnitude and direction of the magnetic field change?

- |     | <u>Magnitude</u> | <u>Direction</u> |
|-----|------------------|------------------|
| (A) | Increases        | Same             |
| (B) | Increases        | Opposite         |
| (C) | Decreases        | Same             |
| (D) | Decreases        | Opposite         |
| (E) | No change        | Opposite         |

**GO ON TO THE NEXT PAGE.**

## SCRATCH WORK

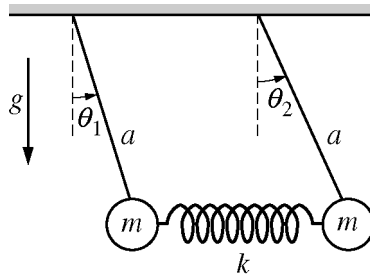

97. The figure above shows two identical simple pendulums, each with mass  $m$  and suspended by a massless rod of length  $a$ . The pendulums are coupled by a massless spring of force constant  $k$ . The coordinates  $\theta_i$  measure the angular displacements from vertical, as shown. Which of the following gives the Lagrangian for the system? (Assume small angular displacements  $\theta_i$ .)

- (A)  $L = \frac{1}{2}ma^2(\dot{\theta}_1^2 + \dot{\theta}_2^2) - \frac{1}{2}mga(\theta_1^2 + \theta_2^2) - \frac{1}{2}ka^2(\theta_2 - \theta_1)^2$
- (B)  $L = \frac{1}{2}ma^2(\dot{\theta}_1^2 + \dot{\theta}_2^2) + \frac{1}{2}mga(\theta_1^2 + \theta_2^2) - \frac{1}{2}ka^2(\theta_2 - \theta_1)^2$
- (C)  $L = \frac{1}{2}ma^2(\dot{\theta}_1^2 + \dot{\theta}_2^2) - \frac{1}{2}mga(\theta_1^2 + \theta_2^2) + \frac{1}{2}ka^2(\theta_2 - \theta_1)^2$
- (D)  $L = \frac{1}{2}ma^2(\dot{\theta}_1^2 + \dot{\theta}_2^2) + \frac{1}{2}mga(\theta_1^2 + \theta_2^2)$
- (E)  $L = \frac{1}{2}ma^2(\dot{\theta}_1^2 + \dot{\theta}_2^2) + \frac{1}{2}ka^2(\theta_2 - \theta_1)^2$

GO ON TO THE NEXT PAGE.



## SCRATCH WORK

98. The spacing between the parallel Bragg planes in a certain crystal is  $d$ . Electrons of fixed energy, corresponding to a given wavelength  $\lambda$ , are incident on the crystal. Which of the following is the minimal condition for strong reflection for at least two different angles?

- (A)  $\lambda > d$
- (B)  $\lambda > \frac{d}{2}$
- (C)  $\lambda < 2d$
- (D)  $\lambda < d$
- (E)  $\lambda < \frac{d}{2}$

99. Consider an electron in the  $n = 4$ ,  $\ell = 1$  state in hydrogen. Which of the following final states can NOT be reached by an allowed transition?

- (A)  $n = 3$ ,  $\ell = 2$
- (B)  $n = 3$ ,  $\ell = 1$
- (C)  $n = 3$ ,  $\ell = 0$
- (D)  $n = 2$ ,  $\ell = 0$
- (E)  $n = 1$ ,  $\ell = 0$

GO ON TO THE NEXT PAGE.

## SCRATCH WORK

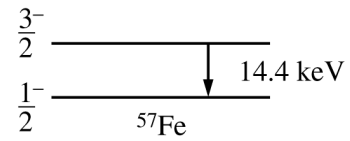
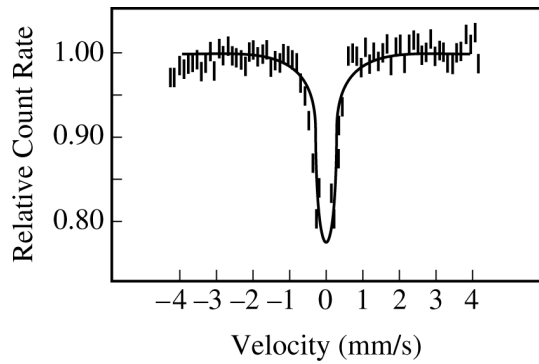

100. A room-temperature Mössbauer absorption spectrum for the 14.4 keV gamma-ray transition of  $^{57}\text{Fe}$  is illustrated in the figure above. From the data, it can be deduced that the lifetime of the  $\frac{3}{2}^-$  excited state is approximately
- (A) 100 ms
  - (B) 100  $\mu\text{s}$
  - (C) 100 ns
  - (D) 100 ps
  - (E) 100 fs

**If you finish before time is called, you may check your work on this test.**

## SCRATCH WORK

NOTE: To ensure prompt processing of test results, it is important that you fill in the blanks exactly as directed.

SUBJECT TEST

A. Print and sign your full name in this box:

PRINT: \_\_\_\_\_  
 (LAST) (FIRST) (MIDDLE)  
 SIGN: \_\_\_\_\_

Copy this code in box 6 on your answer sheet. Then fill in the corresponding ovals exactly as shown.

6. TITLE CODE				
7	7	9	7	6
0	0	0	0	0
1	1	1	1	1
2	2	2	2	2
3	3	3	3	3
4	4	4	4	4
5	5	5	5	5
6	6	6	6	●
●	●	7	●	7
8	8	8	8	8
9	9	●	9	9

Copy the Test Name and Form Code in box 7 on your answer sheet.

TEST NAME Physics  
 FORM CODE GR1777

GRADUATE RECORD EXAMINATIONS SUBJECT TEST

B. The Subject Tests are intended to measure your achievement in a specialized field of study. Most of the questions are concerned with subject matter that is probably familiar to you, but some of the questions may refer to areas that you have not studied.

Your score will be determined by the number of questions you answer correctly. Questions you answer incorrectly or for which you mark no answer or more than one answer are counted as incorrect. Nothing is subtracted from a score if you answer a question incorrectly. Therefore, to maximize your score, it is better for you to guess at an answer than not to respond at all.

You are advised to use your time effectively and to work as rapidly as you can without losing accuracy. Do not spend too much time on questions that are too difficult for you. Go on to the other questions and come back to the difficult ones later if you can.

YOU MUST INDICATE ALL YOUR ANSWERS ON THE SEPARATE ANSWER SHEET. No credit will be given for anything written in this examination book, but you may write in the book as much as you wish to work out your answers. After you have decided on your response to a question, fill in the corresponding oval on the answer sheet. BE SURE THAT EACH MARK IS DARK AND COMPLETELY FILLS THE OVAL. Mark only one answer to each question. No credit will be given for multiple answers. Erase all stray marks. If you change an answer, be sure that all previous marks are erased completely. Incomplete erasures may be read as intended answers. Do not be concerned that the answer sheet provides spaces for more answers than there are questions in the test.

Example:

What city is the capital of France?

- (A) Rome
- (B) Paris
- (C) London
- (D) Cairo
- (E) Oslo

Sample Answer

(A) ● (C) (D) (E)  
 (A) ~~B~~ (C) (D) (E)  
 (A) ~~✓~~ (C) (D) (E)  
 (A) ● (C) (D) (E)  
 (A) ~~F~~ (C) (D) (E)

CORRECT ANSWER  
 PROPERLY MARKED

IMPROPER MARKS

**DO NOT OPEN YOUR TEST BOOK UNTIL YOU ARE TOLD TO DO SO.**



Educational Testing Service  
 Princeton, New Jersey 08541

**Worksheet for the GRE Physics Test, Form GR1777**  
**Answer Key and Percentages\* of Test Takers Answering Each Question Correctly**

QUESTION		P+	CORRECT RESPONSE
Number	Answer		
1	E	92	
2	E	41	
3	E	70	
4	B	64	
5	E	30	
6	B	47	
7	C	59	
8	B	64	
9	D	91	
10	D	59	
11	C	41	
12	E	79	
13	D	77	
14	A	76	
15	C	48	
16	D	53	
17	D	74	
18	C	34	
19	C	70	
20	D	60	
21	E	43	
22	A	49	
23	B	50	
24	C	31	
25	B	51	
26	E	66	
27	A	71	
28	C	47	
29	D	63	
30	E	32	
31	E	32	
32	A	39	
33	A	23	
34	B	82	
35	D	53	
36	D	56	
37	D	52	
38	E	24	
39	C	86	
40	A	23	
41	E	28	
42	D	44	
43	C	41	
44	A	85	
45	A	37	
46	A	76	
47	A	53	
48	B	52	
49	B	49	
50	C	30	

QUESTION		P+	CORRECT RESPONSE
Number	Answer		
51	B	33	
52	B	29	
53	D	39	
54	B	56	
55	B	45	
56	B	64	
57	D	46	
58	A	69	
59	C	20	
60	A	57	
61	B	50	
62	D	36	
63	A	63	
64	E	78	
65	D	43	
66	C	52	
67	E	77	
68	A	71	
69	D	52	
70	D	43	
71	E	32	
72	C	49	
73	E	74	
74	A	53	
75	C	19	
76	E	74	
77	C	43	
78	B	41	
79	C	54	
80	D	26	
81	C	20	
82	D	59	
83	C	25	
84	C	55	
85	A	38	
86	E	50	
87	E	66	
88	B	44	
89	B	47	
90	A	70	
91	E	25	
92	B	55	
93	E	70	
94	D	24	
95	A	22	
96	C	34	
97	A	52	
98	D	22	
99	B	48	
100	C	21	

Total Correct: \_\_\_\_\_

Total Scaled: \_\_\_\_\_

\* The numbers in the P+ column indicate the percentages of test takers in the United States who answer each question correctly.

## Score Conversions for the GRE Physics Test, Form GR1777

TOTAL SCORE			
Total Correct	Scaled Score	Total Correct	Scaled Score
84-100	990	43	590
83	980	42	580
82	970	41	570
81	960	40	560
80	950	38-39	550
79	940	37	540
78	930	36	530
77	920	35	520
76	910	33-34	510
75	900	32	500
74	890	31	490
73	880	30	480
72	870	28-29	470
71	860	27	460
70	850	26	450
69	840	25	440
68	830	23-24	430
67	820	22	420
66	810	21	410
65	800	20	400
64	790	18-19	390
63	780	17	380
62	770	16	370
61	760	14-15	360
60	750	13	350
59	740	12	340
58	730	11	330
57	720	9-10	320
56	710	8	310
55	700	7	300
54	690	6	290
53	680	5	280
52	670	4	270
51	660	1-3	260
50	650	0	250
49	640		
48	630		
47	620		
46	610		
44-45	600		



**1. NAME**  
 Enter your last name, first name initial (given name), and middle initial if you have one.  
 Omit spaces, apostrophes, Jr., II., etc.

Last Name only (Family Name or Surname) - First 15 Letters															
A	A	A	A	A	A	A	A	A	A	A	A	A	A	A	A
B	B	B	B	B	B	B	B	B	B	B	B	B	B	B	B
C	C	C	C	C	C	C	C	C	C	C	C	C	C	C	C
D	D	D	D	D	D	D	D	D	D	D	D	D	D	D	D
E	E	E	E	E	E	E	E	E	E	E	E	E	E	E	E
F	F	F	F	F	F	F	F	F	F	F	F	F	F	F	F
G	G	G	G	G	G	G	G	G	G	G	G	G	G	G	G
H	H	H	H	H	H	H	H	H	H	H	H	H	H	H	H
I	I	I	I	I	I	I	I	I	I	I	I	I	I	I	I
J	J	J	J	J	J	J	J	J	J	J	J	J	J	J	J
K	K	K	K	K	K	K	K	K	K	K	K	K	K	K	K
L	L	L	L	L	L	L	L	L	L	L	L	L	L	L	L
M	M	M	M	M	M	M	M	M	M	M	M	M	M	M	M
N	N	N	N	N	N	N	N	N	N	N	N	N	N	N	N
O	O	O	O	O	O	O	O	O	O	O	O	O	O	O	O
P	P	P	P	P	P	P	P	P	P	P	P	P	P	P	P
Q	Q	Q	Q	Q	Q	Q	Q	Q	Q	Q	Q	Q	Q	Q	Q
R	R	R	R	R	R	R	R	R	R	R	R	R	R	R	R
S	S	S	S	S	S	S	S	S	S	S	S	S	S	S	S
T	T	T	T	T	T	T	T	T	T	T	T	T	T	T	T
U	U	U	U	U	U	U	U	U	U	U	U	U	U	U	U
V	V	V	V	V	V	V	V	V	V	V	V	V	V	V	V
W	W	W	W	W	W	W	W	W	W	W	W	W	W	W	W
X	X	X	X	X	X	X	X	X	X	X	X	X	X	X	X
Y	Y	Y	Y	Y	Y	Y	Y	Y	Y	Y	Y	Y	Y	Y	Y
Z	Z	Z	Z	Z	Z	Z	Z	Z	Z	Z	Z	Z	Z	Z	Z

First Name Initial	(A) (B) (C) (D) (E) (F) (G) (H) (I) (J) (K) (L) (M) (N) (O) (P) (Q) (R) (S) (T) (U) (V) (W) (X) (Y) (Z)
Middle Initial	(A) (B) (C) (D) (E) (F) (G) (H) (I) (J) (K) (L) (M) (N) (O) (P) (Q) (R) (S) (T) (U) (V) (W) (X) (Y) (Z)

**DO NOT USE INK**

Use only a pencil with soft, black lead (No. 2 or HB) to complete this answer sheet. Be sure to fill in completely the space that corresponds to your answer choice. Completely erase any errors or stray marks.

BE SURE EACH MARK IS DARK AND COMPLETELY FILLS THE INTENDED SPACE AS ILLUSTRATED HERE: ●  
 YOU MAY FIND MORE RESPONSE SPACES THAN YOU NEED. IF SO, PLEASE LEAVE THEM BLANK.

1	(A) (B) (C) (D) (E)	24	(A) (B) (C) (D) (E)	47	(A) (B) (C) (D) (E)	70	(A) (B) (C) (D) (E)	93	(A) (B) (C) (D) (E)
2	(A) (B) (C) (D) (E)	25	(A) (B) (C) (D) (E)	48	(A) (B) (C) (D) (E)	71	(A) (B) (C) (D) (E)	94	(A) (B) (C) (D) (E)
3	(A) (B) (C) (D) (E)	26	(A) (B) (C) (D) (E)	49	(A) (B) (C) (D) (E)	72	(A) (B) (C) (D) (E)	95	(A) (B) (C) (D) (E)
4	(A) (B) (C) (D) (E)	27	(A) (B) (C) (D) (E)	50	(A) (B) (C) (D) (E)	73	(A) (B) (C) (D) (E)	96	(A) (B) (C) (D) (E)
5	(A) (B) (C) (D) (E)	28	(A) (B) (C) (D) (E)	51	(A) (B) (C) (D) (E)	74	(A) (B) (C) (D) (E)	97	(A) (B) (C) (D) (E)
6	(A) (B) (C) (D) (E)	29	(A) (B) (C) (D) (E)	52	(A) (B) (C) (D) (E)	75	(A) (B) (C) (D) (E)	98	(A) (B) (C) (D) (E)
7	(A) (B) (C) (D) (E)	30	(A) (B) (C) (D) (E)	53	(A) (B) (C) (D) (E)	76	(A) (B) (C) (D) (E)	99	(A) (B) (C) (D) (E)
8	(A) (B) (C) (D) (E)	31	(A) (B) (C) (D) (E)	54	(A) (B) (C) (D) (E)	77	(A) (B) (C) (D) (E)	100	(A) (B) (C) (D) (E)
9	(A) (B) (C) (D) (E)	32	(A) (B) (C) (D) (E)	55	(A) (B) (C) (D) (E)	78	(A) (B) (C) (D) (E)	101	(A) (B) (C) (D) (E)
10	(A) (B) (C) (D) (E)	33	(A) (B) (C) (D) (E)	56	(A) (B) (C) (D) (E)	79	(A) (B) (C) (D) (E)	102	(A) (B) (C) (D) (E)
11	(A) (B) (C) (D) (E)	34	(A) (B) (C) (D) (E)	57	(A) (B) (C) (D) (E)	80	(A) (B) (C) (D) (E)	103	(A) (B) (C) (D) (E)
12	(A) (B) (C) (D) (E)	35	(A) (B) (C) (D) (E)	58	(A) (B) (C) (D) (E)	81	(A) (B) (C) (D) (E)	104	(A) (B) (C) (D) (E)
13	(A) (B) (C) (D) (E)	36	(A) (B) (C) (D) (E)	59	(A) (B) (C) (D) (E)	82	(A) (B) (C) (D) (E)	105	(A) (B) (C) (D) (E)
14	(A) (B) (C) (D) (E)	37	(A) (B) (C) (D) (E)	60	(A) (B) (C) (D) (E)	83	(A) (B) (C) (D) (E)	106	(A) (B) (C) (D) (E)
15	(A) (B) (C) (D) (E)	38	(A) (B) (C) (D) (E)	61	(A) (B) (C) (D) (E)	84	(A) (B) (C) (D) (E)	107	(A) (B) (C) (D) (E)
16	(A) (B) (C) (D) (E)	39	(A) (B) (C) (D) (E)	62	(A) (B) (C) (D) (E)	85	(A) (B) (C) (D) (E)	108	(A) (B) (C) (D) (E)
17	(A) (B) (C) (D) (E)	40	(A) (B) (C) (D) (E)	63	(A) (B) (C) (D) (E)	86	(A) (B) (C) (D) (E)	109	(A) (B) (C) (D) (E)
18	(A) (B) (C) (D) (E)	41	(A) (B) (C) (D) (E)	64	(A) (B) (C) (D) (E)	87	(A) (B) (C) (D) (E)	110	(A) (B) (C) (D) (E)
19	(A) (B) (C) (D) (E)	42	(A) (B) (C) (D) (E)	65	(A) (B) (C) (D) (E)	88	(A) (B) (C) (D) (E)	111	(A) (B) (C) (D) (E)
20	(A) (B) (C) (D) (E)	43	(A) (B) (C) (D) (E)	66	(A) (B) (C) (D) (E)	89	(A) (B) (C) (D) (E)	112	(A) (B) (C) (D) (E)
21	(A) (B) (C) (D) (E)	44	(A) (B) (C) (D) (E)	67	(A) (B) (C) (D) (E)	90	(A) (B) (C) (D) (E)	113	(A) (B) (C) (D) (E)
22	(A) (B) (C) (D) (E)	45	(A) (B) (C) (D) (E)	68	(A) (B) (C) (D) (E)	91	(A) (B) (C) (D) (E)	114	(A) (B) (C) (D) (E)
23	(A) (B) (C) (D) (E)	46	(A) (B) (C) (D) (E)	69	(A) (B) (C) (D) (E)	92	(A) (B) (C) (D) (E)	115	(A) (B) (C) (D) (E)

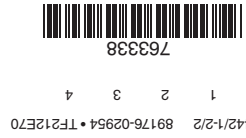

Copyright © 2012 by Educational Testing Service, Princeton, NJ 08541  
 All rights reserved. Printed in U.S.A.  
 Q3442/1-2/2 89176-02954 • TF212E70

**2. YOUR NAME:** (Print) Last Name (Family or Surname) First Name (Given) M.I.

**MAILING ADDRESS:** (Print) P.O. Box or Street Address  
 City State or Province  
 Country ZIP or Postal Code  
 City State or Province

**CENTER:** City Center Number Room Number

**SIGNATURE:**

**3. DATE OF BIRTH**

Month	Day	Year
Jan. (0) (1) (2) (3) (4) (5) (6) (7) (8) (9)	(0) (1) (2) (3) (4) (5) (6) (7) (8) (9)	(0) (1) (2) (3) (4) (5) (6) (7) (8) (9)

**4. LAST FOUR DIGITS OF SOCIAL SECURITY NUMBER** (U.S.A. only)

(0) (1) (2) (3) (4) (5) (6) (7) (8) (9)	(0) (1) (2) (3) (4) (5) (6) (7) (8) (9)	(0) (1) (2) (3) (4) (5) (6) (7) (8) (9)	(0) (1) (2) (3) (4) (5) (6) (7) (8) (9)
---	---	---	---

**5. REGISTRATION NUMBER** (from your admission ticket)

(0) (1) (2) (3) (4) (5) (6) (7) (8) (9)	(0) (1) (2) (3) (4) (5) (6) (7) (8) (9)	(0) (1) (2) (3) (4) (5) (6) (7) (8) (9)	(0) (1) (2) (3) (4) (5) (6) (7) (8) (9)
---	---	---	---

**6. TITLE CODE** (on back cover of your test book)

(0) (1) (2) (3) (4) (5) (6) (7) (8) (9)	(0) (1) (2) (3) (4) (5) (6) (7) (8) (9)	(0) (1) (2) (3) (4) (5) (6) (7) (8) (9)	(0) (1) (2) (3) (4) (5) (6) (7) (8) (9)
---	---	---	---

**7. TEST NAME** (on back cover of your test book)

**FORM CODE** (on back cover of your test book)

**8. TEST BOOK SERIAL NUMBER** (number in upper right corner of front cover of your test book)

**SHADED AREA FOR ETS USE ONLY**

Item responses continued on reverse side.

SUBJECT TEST

COMPLETE THE  
CERTIFICATION STATEMENT,  
THEN TURN ANSWER SHEET  
OVER TO SIDE 1.

CERTIFICATION STATEMENT

Please write the following statement below, DO NOT PRINT.

"I certify that I am the person whose name appears on this answer sheet. I also agree not to disclose the contents of the test I am taking today to anyone."  
Sign and date where indicated.

\_\_\_\_\_

\_\_\_\_\_

\_\_\_\_\_

\_\_\_\_\_

SIGNATURE: \_\_\_\_\_ DATE: \_\_\_\_\_ / \_\_\_\_\_ / \_\_\_\_\_  
Month Day Year

BE SURE EACH MARK IS DARK AND COMPLETELY FILLS THE INTENDED SPACE AS ILLUSTRATED HERE: ● .  
YOU MAY FIND MORE RESPONSE SPACES THAN YOU NEED. IF SO, PLEASE LEAVE THEM BLANK.

116	A B C D E	148	A B C D E	180	A B C D E	212	A B C D E
117	A B C D E	149	A B C D E	181	A B C D E	213	A B C D E
118	A B C D E	150	A B C D E	182	A B C D E	214	A B C D E
119	A B C D E	151	A B C D E	183	A B C D E	215	A B C D E
120	A B C D E	152	A B C D E	184	A B C D E	216	A B C D E
121	A B C D E	153	A B C D E	185	A B C D E	217	A B C D E
122	A B C D E	154	A B C D E	186	A B C D E	218	A B C D E
123	A B C D E	155	A B C D E	187	A B C D E	219	A B C D E
124	A B C D E	156	A B C D E	188	A B C D E	220	A B C D E
125	A B C D E	157	A B C D E	189	A B C D E	221	A B C D E
126	A B C D E	158	A B C D E	190	A B C D E	222	A B C D E
127	A B C D E	159	A B C D E	191	A B C D E	223	A B C D E
128	A B C D E	160	A B C D E	192	A B C D E	224	A B C D E
129	A B C D E	161	A B C D E	193	A B C D E	225	A B C D E
130	A B C D E	162	A B C D E	194	A B C D E	226	A B C D E
131	A B C D E	163	A B C D E	195	A B C D E	227	A B C D E
132	A B C D E	164	A B C D E	196	A B C D E	228	A B C D E
133	A B C D E	165	A B C D E	197	A B C D E	229	A B C D E
134	A B C D E	166	A B C D E	198	A B C D E	230	A B C D E
135	A B C D E	167	A B C D E	199	A B C D E	231	A B C D E
136	A B C D E	168	A B C D E	200	A B C D E	232	A B C D E
137	A B C D E	169	A B C D E	201	A B C D E	233	A B C D E
138	A B C D E	170	A B C D E	202	A B C D E	234	A B C D E
139	A B C D E	171	A B C D E	203	A B C D E	235	A B C D E
140	A B C D E	172	A B C D E	204	A B C D E	236	A B C D E
141	A B C D E	173	A B C D E	205	A B C D E	237	A B C D E
142	A B C D E	174	A B C D E	206	A B C D E	238	A B C D E
143	A B C D E	175	A B C D E	207	A B C D E	239	A B C D E
144	A B C D E	176	A B C D E	208	A B C D E	240	A B C D E
145	A B C D E	177	A B C D E	209	A B C D E	241	A B C D E
146	A B C D E	178	A B C D E	210	A B C D E	242	A B C D E
147	A B C D E	179	A B C D E	211	A B C D E		

**IF YOU DO NOT WANT THIS ANSWER SHEET TO BE SCORED**

If you want to cancel your scores from this test administration, complete A and B below. You will not receive scores for this test. No record of this test or the cancellation will be sent to the recipients you indicated, and there will be no scores for this test on your GRE file.

To cancel your scores from this test administration, you must:

A. Fill in both circles here . . . ○ — ○ B. Sign your full name here: \_\_\_\_\_

TR	TW	TFS	TCS	1R	1W	1FS	1CS	2R	2W	2FS	2CS
FOR ETS USE ONLY				3R	3W	3FS	3CS	4R	4W	4FS	4CS
				5R	5W	5FS	5CS	6R	6W	6FS	6CS



*Measuring the Power of Learning.®*

[www.ets.org](http://www.ets.org)

120774-007627 • UNLWEB617