

# Quantization in Astrophysics, Brownian Motion, and Supersymmetry

Including articles never before published

**F. Smarandache & V. Christianto**  
(editors)

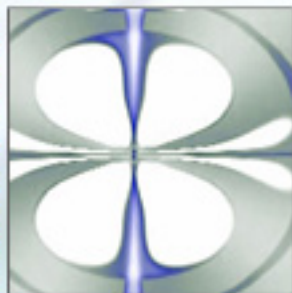
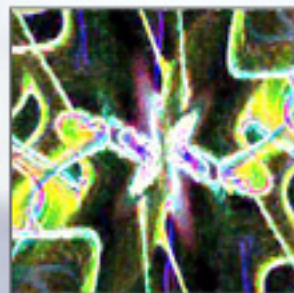
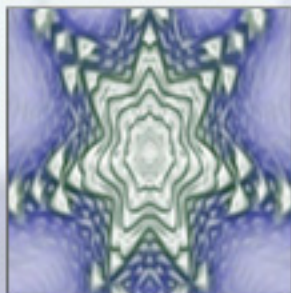
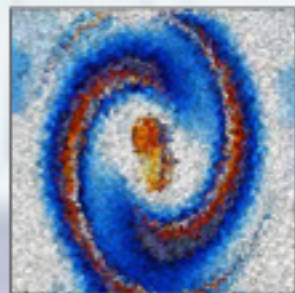

**MathTiger, 2007**

**Chennai, Tamil Nadu, India**

**ISBN 819021909X**

# Quantization in Astrophysics, Brownian Motion, and Supersymmetry

F. Smarandache & V. Christianto  
(editors)

Including articles never before published

**MathTiger, 2007**  
**Chennai, Tamil Nadu**  
**ISBN: 81-902190-9-X**  
**Printed in India**

This book can be ordered in a paper bound reprint from:

**Books on Demand**

ProQuest Information & Learning  
(University of Microfilm International)  
300 N. Zeeb Road  
P.O. Box 1346, Ann Arbor  
MI 48106-1346, USA  
Tel.: 1-800-521-0600 (Customer Service)  
<http://wwwlib.umi.com/bod/basic>

**Copyright** 2007 by MathTiger and Authors for their own articles.

Many books can be downloaded from the following

**Digital Library of Science:**

<http://www.gallup.unm.edu/~smarandache/eBooks-otherformats.htm>

Covers art (digital painting) by F. Smarandache.

**Peer Reviewers:**

1. Prof. E. Scholz, Dept. of Mathematics, Wuppertal University, Germany
2. Prof. T.R. Love, Dept. of Mathematics & Dept. of Physics,  
California State University at Dominguez Hills
3. Dr. S. Trihandaru, Dept. of Physics, UKSW

**(ISBN-10) 81-902190-9-X**

**(ISBN-13) 978-81-902190-9-9**

**(EAN) 9788190219099**

**Printed in India**

## Quantization in Astrophysics, Brownian Motion, and Supersymmetry

The present book discusses, among other things, various quantization phenomena found in Astrophysics and some related issues including Brownian Motion. With recent discoveries of exoplanets in our galaxy and beyond, this Astrophysics quantization issue has attracted numerous discussions in the past few years.

Most chapters in this book come from published papers in various peer-reviewed journals, and they cover different methods to describe quantization, including Weyl geometry, Supersymmetry, generalized Schrödinger, and Cartan torsion method. In some chapters Navier-Stokes equations are also discussed, because it is likely that this theory will remain relevant in Astrophysics and Cosmology

While much of the arguments presented in this book are theoretical, nonetheless we recommend further observation in order to verify or refute the propositions described herein. It is of our hope that this volume could open a new chapter in our knowledge on the formation and structure of Astrophysical systems.

The present book is also intended for young physicist and math fellows who perhaps will find the arguments described here are at least worth pondering.



# Preface

This book, titled *Quantization in Astrophysics, Brownian Motion, and Supersymmetry*, is a collection of articles to large extent inspired by some less-understood empirical findings of Astrophysics and Cosmology. Examples in relation to these findings are small but non-vanishing cosmological constant and accelerating cosmological expansion, indication of dark matter and dark energy, the evidence for approximate Bohr quantization of radii of planetary orbits involving gigantic value of effective (or real) Planck constant, Pioneer anomaly and flyby anomalies, and the Tiffit's redshift quantization.

There is recently no generally accepted theoretical approach to these anomalies and the book is intended to provide a representative collection of competing theories and models. The general theoretical backgrounds indeed cover a wide spectrum: mention only Nottale's Scale Relativity and Schrödinger equation assigned with Brownian motion and its modification proposed by Carlos Castro (#6), Castro's Extended Relativity in Clifford algebra and Weyl geometry based cosmology (#8), Diego Rapoport's work with Cartan-Weyl space-time geometry and representation of random structures via torsion fields (#16,#17), and Pitkanen's Topological Geometroynamics (#3).

In the case of dark matter and energy the proposals include Castro's proposal for cosmology based on Weyl geometry (#7). The approach of Pitkanen relies of the identification of dark matter as a hierarchy of macroscopic quantum phases with arbitrarily large values of ordinary Planck constant.

In the case of planetary Bohr orbitology one plausible method is based on Nottale's Scale Relativity inspired proposal that fractal hydrodynamics is equivalent with Schrödinger equation with effective Planck constant which depends on the properties of system and by *Equivalence Principle* is proportional to the product of interacting gravitational masses in the recent case. Note that Nottale predicted Bohr quantization already 1993, much before exoplanets provided further evidence for it. Other early papers describing exoplanets are 1998-1999 *Fizika* paper of A. Rubcic and J. Rubcic on Bohr quantization for planets and exoplanets, which are included here for clarity (#1 & #2).

Several models for the planetary quantization are discussed: Fu Yuhua's approach relies on Hausdorff fractal dimension (#5); F. Smarandache & V. Christianto discuss a plausible extension of Nottale's generalized Schrödinger equation to Ginzburg-Landau (Gross-Pitaevskii) equation based on phion condensate model (#11, #14, #26), which can also be considered as superfluid vortex in Cantorian spacetime; M.

Pitkanen's approach explains planetary Bohr orbitology as being a reflection of the quantal character of dark matter in astrophysical length and time scales.

The present book also discuss solutions to a number of known problems with respect to Relativity, Quantum Mechanics, Astrophysics, i.e. Bell's theorem (F. Smarandache & V. Christianto, #14), holographic dark energy (Gao Shan, #18), unified thermostatics (F. Smarandache & V. Christianto, #25), hypergeometrical universe and supersymmetry (M. Pereira, #19), rotational aspects of relativity (A. Yefremov, #21, #22), and also Pioneer anomaly (#20, #23, #24).

In the case of Pioneer anomaly the explanations include modifications of Newton's gravitational potential and the notion of metric in general relativity, dark matter induced acceleration, the acceleration anomaly induced by the compensation of cosmic expansion in planetary length scale, and mechanism inducing anomalous Doppler frequency shift as Q-relativity effect. (Perhaps this Doppler frequency shift is comparable with a daily idiom: "The grass always *looks* greener on the other side of the fence.")\*

We would like to express our special thanks to journal editors for their kind permission to us to include these published papers in this volume, and for all peer-reviewers for their patience in reading our submitted drafts, and suggesting improvement.

It is our hope that the present book could open a new chapter in our knowledge on the formation and structure of Astrophysical systems.

November 26<sup>th</sup>, 2006  
M. Pitkanen

---

\* German: Kirschen in Nachbars Garten sind immer süßer. Ref:  
<http://www.proz.com/kudoz/1020232>. Also <http://www.usingenglish.com/reference/idioms/t.html>

# Foreword

*"The first principles of things will never be adequately known. Science is an open ended endeavor, it can never be closed. We do science without knowing the first principles. It does in fact not start from first principles, nor from the end principles, but from the middle. We not only change theories, but also the concepts and entities themselves, and what questions to ask. The foundations of science must be continuously examined and modified; it will always be full of mysteries and surprises."*  
(A.O. Barut, *Foundation of Physics* 24(11), Nov. 1994, p.1571)

The present book is dedicated in particular for various quantization phenomena found in Astrophysics. It includes various published (and unpublished) papers discussing how 'macroquantization' could be described through different frameworks, like Weyl geometry, or Cartan torsion field, or generalizing Schrödinger equation.

To our present knowledge, quantization in various Astrophysics phenomena has not been studied extensively yet, except by a number of physicists. Mostly, it is because of scarcity of theoretical guidance to describe such '*macroquantization phenomena*'. For decades, it becomes too 'obvious' for some physicists that quantum physics will reduce to (semi)-classical mechanics as the scale grows. But as numerous recent Astrophysical findings have shown, 'quantization' is also observed in macro-physics phenomena, which indicates that quantum physics also seem to play significant role to describe those celestial objects.

Nonetheless, it is worth noting here that the wavefunction description of the Universe has been known since 1970s, for instance using Wheeler-DeWitt (Einstein-Schrödinger) equation, or Hartle's, Vilenkin's method in 1980s, albeit it is also known that these approaches lack sufficient vindication in terms of Astrophysics data. Therefore, from this viewpoint, the quantization description of Astrophysical systems is merely a *retro* and improved version of those earlier ideas. Or, if we are allowed to paraphrasing John Wheeler in this context, perhaps we could say: "Time is Nature's way to avoid all things from happening at once, and Quantization is Nature's way to bring arrangement and to avoid all things from colliding because of n-bodies interaction," (as shown by Poincare in early 20<sup>th</sup> century).

We would like to express our sincere gratitude not only to a number of journal editors for their kind permission to enable us include these published papers in this volume (including *Fizika* editor, *AFLB* editor, *EJTP* editor, *PiP* editor, *Gravitation and Cosmology* editor and *Apeiron* editor); but also to Profs. E. Scholz, T. Love and S. Trihandaru for their patience in reading the draft version of this book. And to numerous colleagues and friends who share insightful discussions and with whom we have been working with.

As concluding remark to this foreword, we would like to note that after pre-release of this book (at <http://www.gallup.unm.edu/~smarandache/Quantization.pdf>), it has attracted not less than 1325 hits (downloads) to this book in the first three days (January 21<sup>st</sup>, 2007), and 3708 hits within the first five days (January 24<sup>th</sup>, 2007). Perhaps the printed version of this volume will be appreciated in similar way.

January 26<sup>th</sup>, 2007.  
F.S. & V.C.



# Quantization in Astrophysics, Brownian Motion, and Supersymmetry

F. Smarandache & V. Christianto  
(editors)

Preface	iv
Foreword	vi
Content	viii

## Quantization in Astrophysics, Tiffit redshift, and generalized Schrödinger equation

1. Square laws for orbits in Extra-Solar Planetary Systems – A. Rubcic & J. Rubcic (*Fizika A* 8, 1999, 2, 45-50) 1
2. The quantization of the solar-like gravitational systems – A. Rubcic & J. Rubcic (*Fizika B* 7, 1998, 1, 1-13) 7
3. Quantization of Planck Constants and Dark Matter Hierarchy in Biology and Astrophysics – M. Pitkanen (Oct. 28<sup>th</sup>, 2006) 20
4. Could q-Laguerre equation explain the chained fractionation of the principal quantum number for hydrogen atom? – M. Pitkanen (Oct. 2006) 58
5. On quantization in Astrophysics – Fu Yuhua (Oct, 4<sup>th</sup> 2006) 68

## Weyl Geometry, Extended Relativity, Supersymmetry, and application in Astrophysics

6. On Nonlinear Quantum Mechanics, Brownian Motion, Weyl Geometry, and Fisher Information – C. Castro & J. Mahecha (*Progress in Physics*, Vol. 2 No. 1, 2006) 72
7. Does Weyl's Geometry solve the Riddle of Dark Energy? – C. Castro (a condensed version of forthcoming paper in *Foundation of Physics*, 2006) 88
8. The Extended Relativity Theory in Clifford spaces – C. Castro & M. Pavsic (*Progress in Physics*, Vol. 1 No. 2, 2005) 97
9. On Area Coordinates and Quantum Mechanics in Yang's Noncommutative Spacetime with a Lower and Upper Scale – C. Castro (*Progress in Physics*, Vol. 2 No. 2, 2006) 162
10. Running Newtonian Coupling and Horizonless Solutions in Quantum Einstein Gravity – C Castro, J.A. Nieto, J.F. Gonzalez (8<sup>th</sup> Dec. 2006) 178

## Quantization in Astrophysics and phion condensate: *Five Easy Pieces*

11. On the origin of macroquantization in Astrophysics and Celestial Motion – V. Christianto (*Annales de la Fondation Louis De Broglie*, Vol. 31, 2006) 202
12. The Cantorian superfluid vortex hypothesis – V. Christianto (*Apeiron* Vol. 10, No. 3, 2003) 214
13. A note on geometric and information fusion interpretation of Bell's theorem and quantum measurement – F. Smarandache & V. Christianto (*Progress in Physics* Vol. 2, 2006) 232
14. Plausible explanation of Quantization of Intrinsic Redshift from Hall effect and Weyl Quantization - F. Smarandache & V. Christianto (*Progress in Physics* Vol. 2, 2006) 241
15. A new wave quantum relativistic equation from Quaternionic Representation of Maxwell-Dirac isomorphism – V. Christianto (*EJTP*, Vol. 3(12), 2006, 117-144) 248

## Cartan-Weyl space time, Torsion fields, and Navier-Stokes

16. Torsion Fields, the Quantum Potential, Cartan-Weyl Space-Time and State-Space Geometries and their Brownian Motions – D.L. Rapoport (Dec 8<sup>th</sup>, 2006) 276
17. Viscous and Magnet -Fluid-Dynamics, Torsion Fields, and Brownian Motions Representations on Compact Manifolds and the Random Symplectic Invariants - D.L. Rapoport (Dec. 16<sup>th</sup>, 2006) 329
18. A note on Holographic Dark Energy – Gao Shan (Nov., 2006) 386

## Hypergeometrical Universe, Pioneer Anomaly, Quaternion Relativity

19. Hypergeometrical Universe - M. Pereira (8<sup>th</sup> January, 2007) 391
20. Three Solar System anomalies indicating the presence of Macroscopically Coherent Dark Matter in Solar System - M. Pitkanen (Nov., 2006) 433
21. Relativistic Oscillator in Quaternion Relativity – A. Yefremov (Nov. 2006) 440
22. Quaternionic Relativity. II Non-inertial motions – A. Yefremov (*Grav. & Cosmology*, Vol. 2, 1996) 458
23. Relativistic Doppler effect and Thomas Precession in Arbitrary Trajectories (and comment on Pioneer anomaly) – A. Yefremov (8<sup>th</sup> Jan. 2007) 469
24. Less mundane explanation of Pioneer anomaly from Q-relativity – F. Smarandache and V. Christianto (*Progress in Physics* Vol. 3 No.1 2007) 473
25. A note on unified statistics including Fermi-Dirac, Bose-Einstein, and Tsallis statistics, and plausible extension to anisotropic effect – V. Christianto & F. Smarandache (Jan. 8<sup>th</sup>, 2007) 481
26. Numerical solution of Time-dependent gravitational Schrödinger equation -- V. Christianto, D. Rapoport, F. Smarandache (Jan. 2<sup>nd</sup>, 2007) 487

Abstract 505

# Quantization in Astrophysics, Tifft redshift, and generalised Schrodinger equation

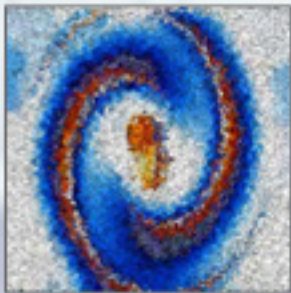

SQUARE LAW FOR ORBITS IN EXTRA-SOLAR PLANETARY SYSTEMS

ANTUN RUBČIĆ and JASNA RUBČIĆ

*Department of Physics, University of Zagreb, Bijenička 32,  
10000 Zagreb, Croatia  
E-mail: rubcic@sirius.phy.hr*

Received 27 April 1999; Accepted 1 September 1999

Reprinted with kind permission from editor of *Fizika A*

The square law  $r_n = r_1 n^2$  for orbital sizes  $r_n$  ( $r_1$  is a constant dependent on the particular system, and  $n$  are consecutive integer numbers) is applied to the recently discovered planets of  $\nu$  Andromedae and to pulsars PSR B1257+12 and PSR 1828-11. A comparison with the solar planetary system is made. The product  $nv_n$  of the orbital velocity  $v_n$  with the corresponding orbital number  $n$  for planets of  $\nu$  Andromedae is in good agreement with those for terrestrial planets, demonstrating the generality of the square law in dynamics of diverse planetary systems. "Quantized velocity" of  $nv_n$  is very close to  $24 \text{ km s}^{-1}$ , i.e. to the step found in the quantized redshifts of galaxies. A definite conclusion for planetary systems of pulsars requires additional observations.

PACS numbers: 95.10.Ce, 95.10.Fh, 95.30.-t

UDC 523.2, 531.35

Keywords: planets of  $\nu$  Andromedae and of pulsars PSR B1257+12 and PSR 1828-11, square law for orbital sizes, "quantized velocity"  $nv_n$

In our previous papers [1,2], the orbital distribution of planets and satellites in the solar system has been described by the simple square law

$$r_n = r_1 n^2. \quad (1)$$

Semimajor axes  $r_n$  of planetary and satellite orbits are proportional to the square of consecutive integer numbers  $n$ , where  $r_1$  is a constant dependent on the system. We have also applied the square law to the planetary system of the pulsar PSR B1257+12 [3].

Very recently, the planetary system of the nearby star  $\nu$  Andromedae (from hereafter:  $\nu$  And) has been discovered using the Doppler radial velocity method [4]. It is the first system of multiple companions with a parent star similar to the Sun. Therefore, it is important to check whether the planets of  $\nu$  And obey also the square law. Moreover, the planets of the pulsar PSR 1828-11 will be considered,

too, although the present findings are not yet confirmed. So far, only three extra-solar planetary systems with more than one observed planet per system have been discovered.

The observational data for  $\nu$  And and two pulsars are given in Table 1. Note that masses ( $M$ ) of planets of  $\nu$  And, and those of the pulsars are of the order of the Jupiter mass ( $M_J$ ) and Earth mass ( $M_E$ ), respectively. Question mark added to the planet A of PSR B1257+12 means that original results [5] have been questioned [6] with the suggestion that planet A might be an artefact in the calculations.

TABLE 1. Semimajor axes  $r_n$ , masses ( $M$ )  $\sin(i)$ , deduced orbital numbers  $n$ , products of  $n$  with the corresponding orbital velocity  $v_n$ , and the mean values of  $nv_n$  for extra-solar planetary systems.

System	$r_n/(10^{11}\text{m})$	$(M) \sin(i)$	$n$	$nv_n/(\text{km s}^{-1})$
$\nu$ Andromedae				
$\nu$ And b	0.0883	0.71 ( $M_J$ )	1	138.52
$\nu$ And c	1.242	2.11 "	4	147.7
$\nu$ And d	3.740	4.61 "	7	<u>148.99</u>
				145.08
PSRB1257 + 12				
A(?)	0.285	0.015 ( $M_E$ )	5	410.49
B	0.540	3.4 "	7	417.50
C	0.705	2.8 "	8	<u>417.59</u>
				415.20
PSR 1828-11				
A	1.391	3 ( $M_E$ )	6	208.57
B	1.975	12 "	7	204.21
C	3.142	18 "	9	<u>208.16</u>
				206.98

Data are taken from: Jean Schneider, *Extra-solar Planets Encyclopaedia*, update 15 April 1999. <http://www.obspm.fr/planets>

In order to determine the orbital numbers  $n$  for the particular system, the square roots of orbital semimajor axes have been plotted vs. integer numbers in such a way that all observational points are close to a straight line without an intercept. Deviations of the observational points from the straight line for pulsar planetary systems are found to be less than 2%, while those of  $\nu$  And less than 6.2% on the average.

The results of the fit to the data in Table 1 are shown in Fig. 1. The square law satisfactorily describes orbital sizes in extra-solar planetary systems, in spite of the fact that only few planets per system have been found. It is evident that

some orbits predicted by the square law are not occupied. For the planetary system of  $\nu$  And, the orbits at  $n$  equal to 2, 3, 5, and 6 are vacant. It may be that at these orbits small planets exist, but undetectable by the present methods. Future observations should confirm or disprove these assumptions.

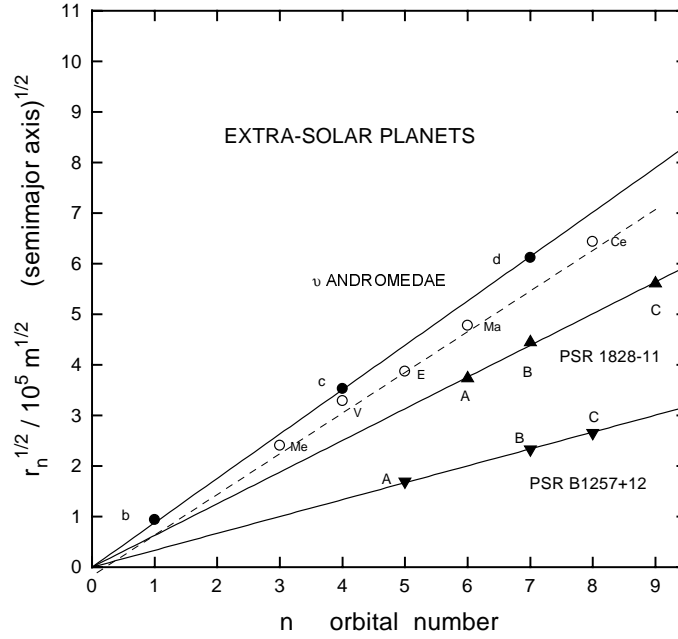

Fig. 1. Correlation of the square root of the semimajor axes  $r_n$  with the orbital numbers  $n$  for extra-solar planetary systems. Terrestrial planets (open circles, dashed line) are added for comparison.

We have shown [1] that the radius and velocity at the  $n$ -th orbit (within the approximation of circular orbits) is proportional to  $n^2$  and  $1/n$ , respectively. Further investigation [2] has shown that along with the orbital number  $n$ , an additional number  $k$  may be introduced, resulting in the following relationships

$$r_n = \frac{G}{v_0^2} M \frac{n^2}{k^2}, \quad (2)$$

$$v_n = v_0 \frac{k}{n}, \quad (3)$$

where  $G$  is the gravitational constant,  $M$  the mass of the central body, and  $v_0$  a fundamental velocity, which may be considered as an important quantity of all considered systems.

The integer number  $n$  determines the quadratic increase of orbital radii, while  $k$  defines the extension or spacing of orbits. By increasing  $k$ , orbits are more closely

packed. Thus  $k$  may be named the "spacing number" to differ from the main "orbital number"  $n$ . Equation (3) states that  $nv_n$  is a constant for a given system, and for some other systems it is a multiple of the fundamental velocity  $v_0$ . Indeed, this has been demonstrated for the solar system [2], i.e. for its five subsystems: the terrestrial planets and the largest asteroid Ceres ( $k = 6$ ), the Jovian planets ( $k = 1$ ), and satellites of Jupiter ( $k = 2$ ), Saturn ( $k = 4$ ) and Uranus ( $k = 1$ ). For all these subsystems, the value of  $nv_n = kv_0$  is given by  $(25.0 \pm 0.7)k \text{ km s}^{-1}$  [2], confirming thus Eq. (3). It has to be pointed out that more accurate value of  $nv_n = [(23.5 \pm 0.3)k + (4.0 \pm 1.0)] \text{ km s}^{-1}$  was obtained (Eq.(12) in Ref. [2]). A similar situation for orbital velocities may be expected in extra-solar systems.

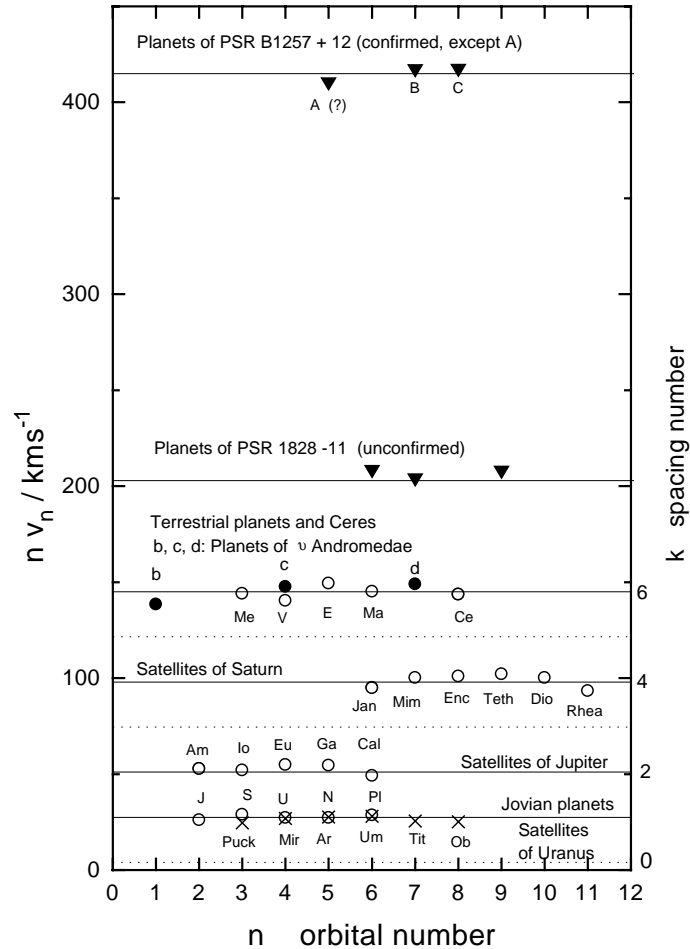

Fig. 2. Correlation of the products of orbital numbers  $n$  and orbital velocities  $v_n$  with  $n$  and the spacing number  $k$ , for the solar subsystems and three extra-solar planetary systems.

The correlation of  $nv_n$  with  $n$  and  $k$  is shown in Fig. 2. This figure is based on Fig. 3. of Ref. [2], where only data for the solar system have been taken into account. Here, it is supplemented by the extra-solar system data of  $\nu$  And and pulsars PSR 1828-11 and PSR B1257+12. Figure 2 demonstrates that new data of the planetary system of  $\nu$  And, with the mean value of  $nv_n$  equal to  $145.1 \text{ km s}^{-1}$  (see Table 1), are compatible with the data for terrestrial planets of the solar system, for which  $nv_n$  has almost the same value of  $145.0 \text{ km s}^{-1}$  [2]. A similarity among the two planetary systems can be seen also in Fig. 1. Although the number of planets for pulsar planetary systems are small, one may notice the well defined "velocity levels" with the step of nearly  $207 \text{ km s}^{-1}$ . However, one should not take this as a final result because only two  $nv_n$  are known. Future discoveries of other pulsar planetary systems will probably change the number of levels defined by  $k$  in Fig. 2. Indeed, one may even expect that the step of  $207 \text{ km s}^{-1}$  might be decreased to  $207/8 = 25.9 \text{ km s}^{-1}$ , which is nearly equal to that of the solar system. This would lead to the similarity in dynamical properties of diverse systems. However, only future observations should give a definite answer to these expectations.

The velocity about  $24 \text{ km s}^{-1}$  is deduced from the quantized redshifts of galaxies [7-11] as one of the possible "quantized periods". Some other values like 36, 72 and  $144 \text{ km s}^{-1}$  are also found. It is a great puzzle why the orbital velocities should be related to the velocities derived from redshifts. However, one suspects that some fundamental link exists among the systems.

Some authors prefer the fundamental velocity of about  $144 \text{ km s}^{-1}$  [12-14]. This was found for planets in the solar system if one takes all planets as a single system. In the present model, the terrestrial planets are located at the level  $k = 6$ , and Jovian planets at  $k = 1$ , because  $v_0$  is adopted to be  $24 \text{ km s}^{-1}$ . In that case, Jovian planets are considered as a subsystem with  $n = 2$  for Jupiter,  $n = 3$  for Saturn, etc., as can be seen in Fig. 2 (see also Refs. [1-3]). The terrestrial planets could be considered as the remnants of mass of a Jupiter-like planet, which failed to be formed at  $n = 1$  [1,14]. However, terrestrial planets may be taken as an independent subsystem, with Mercury at  $n = 3$ , Venus at  $n = 4$ , etc., as can be seen in Figs. 1 and 2.

The assumption  $v_0 \approx 144 \text{ km s}^{-1}$  will introduce many vacant orbits between Jupiter and Pluto, if the square law for orbital radii is taken into account. Thus, Jupiter will be at  $n = 11$ , Saturn at  $n = 15$ , Uranus at  $n = 21$ , Neptune at  $n = 26$  and finally Pluto at  $n = 30$ . An analysis of the solar-system data suggests that planets of  $\nu$  And are located at the velocity level  $k = 6$ , with  $v_0 \approx 24 \text{ km s}^{-1}$ . If  $v_0$  is taken to be  $144 \text{ km s}^{-1}$ , then  $k$  will be equal to one. Consequently, the value of  $k$ , e.g., for the Jovian planets would be then  $1/6$ . According to the present model, that does not seem likely, because the "spacing number"  $k$  is defined as an integer number and determines the packing of orbits.

There is a hope that the same value  $v_0$  can be attributed to the systems around alike stars. For pulsars, one may suppose that  $v_0$  could be equal to about  $26 \text{ km s}^{-1}$  and consequently  $k$  should be equal to 8 and 16 for PSR 1828-11 and PSR B1257+12, respectively. Although this assumption seems very attractive, it cannot be confirmed without further observations.



In conclusion, one may claim that the square law is adequate for the description of the orbital distribution for diverse systems: solar subsystems, extra-solar planetary systems with stars similar to the Sun and even to planetary systems of pulsars.

#### *Acknowledgements*

The authors are very grateful to Profs. H. Arp and K. Pavlovski for their permanent interest, suggestions and support throughout the work.

#### References

- 1) A. Rubčić and J. Rubčić, *Fizika B* **4** (1995) 11;
- 2) A. Rubčić and J. Rubčić, *Fizika B* **7** (1998) 1;
- 3) A. Rubčić and J. Rubčić, *Fizika B* **5** (1996) 85;
- 4) P. Butler, G. Marcy, D. Fischer, T. Brown, A. Contos, S. Korzennik, P. Nisenson and R. Noyes, *Evidence for multiple companions to upsilon Andromedae*, *ApJ* (1999) (in press);
- 5) A. Wolszczan, in *Compact Stars and Binaries*, J. van Paradijs et al. (Eds), *Proc. IAU Symp.* **165** (1996) 187;
- 6) K. Scherer, H. Fichtner, J.D. Anderson and E.L. Lau, *Science* **278** no. 5345 (1997) 1919;
- 7) W. G. Tift, *ApJ* **206** (1976) 38;
- 8) H. Arp and J. W. Sulentic, *ApJ* **291** (1985) 88;
- 9) W. J. Cocke and W. G. Tift, *BAAS* **26** (1994) 1409;
- 10) B. N. G. Guthrie and W. M. Napier, *Astron. Astrophys.* **310** (1996) 353;
- 11) H. Arp, *Seeing Red: Redshifts, Cosmology and Academic Science*, Apeiron, Montreal, Canada (1998) pp.195-223;
- 12) A. G. Agnese and R. Festa, *Hadronic Journal* **21** (1998) 237;
- 13) G. Reinisch, *Astron. Astrophys.* **337** (1998) 299;
- 14) L. Nottale, *Chaos, Solitons and Fractals* **9** (no. 7) (1998) 1043.

# THE QUANTIZATION OF THE SOLAR-LIKE GRAVITATIONAL SYSTEMS

ANTUN RUBČIĆ and JASNA RUBČIĆ

*Department of Physics, Faculty of Science, University of Zagreb, Bijenička cesta 32, HR-10001 Zagreb, Croatia; e-mail rubcic@sirius.phy.hr*

Received 24 January 1998; Accepted 1 June 1998

Reprinted with kind permission from editor of *Fizika B*

Mean orbital distances  $r_n$  of planets from the Sun and of major satellites from the parent planets Jupiter, Saturn and Uranus are described by the square law  $r_n = r_1 n^2$ , where the values of  $n$  are consecutive integers, and  $r_1$  is the mean orbital distance expected at  $n = 1$  for a particular system. Terrestrial planets and Jovian planets are analysed as separate systems. Thus, five independent solar-like systems are considered. The basic assumption is that specific orbital angular momentum is "quantized". Consequently, all orbital parameters are also discrete. The number  $n$  relates to the law of orbital spacing. An additional discretization, related to  $r_1$ , i.e. to the scale of orbits, accounts for the detailed structure of planar gravitational systems. Consequently, it is also found that orbital velocity  $v_n$  multiplied by  $n$  is equal to the multiple of a fundamental velocity  $v_0 \approx 24 \text{ km s}^{-1}$ , valid for all subsystems in the Solar System. This velocity is equal to one of the "velocity" increments of quantized redshifts of galaxies.

PACS numbers: 95.10.Ce, 95.10.Fh, 96.30.-t

UDC 523.2, 531.35

Keywords: planetary and satellite orbits, law of squares of integer numbers, discrete values of orbital velocities

## 1. Introduction

Recently, Agnese and Festa [1] published their approach in explaining discrete orbital spacing of planets in the Solar System. They used Bohr-Sommerfeld quantization rules and obtained the square law for orbital radii of planets in the form  $a_n = a_1 n^2$ ,  $n = 1, 2, 3 \dots$ . All planets have been treated as one group. That assumption leads to many vacant orbits.

For example, Jupiter and Saturn occupy the orbits at  $n = 11$  and  $n = 15$ , respectively, leaving three vacant orbits in between. Likewise, there are five vacant orbits between Saturn and Uranus. However, according to the current views [2], the planets are about as closely spaced as they could possibly be. Less massive planets are expected to be in more tightly packed orbits than the larger ones.

Recently, Oliveira Neto [3] used the square law in the form  $r_{n,m} = r_0(n^2 + m^2)/2$ , where  $n$  and  $m$  are integers. Only for Venus, Earth, Mars and Vesta  $m$  is not equal to  $n$ , while  $n = m$  for all other planets, asteroid Camilla, Chiron and an unknown planet between Uranus and Neptune. Moreover, an average mass of all planets and asteroids equal to about 35 Earth masses is assumed in the calculation, which is not physically justified

In our earlier work [4,5], we have shown that a square law could be applied to planetary orbital mean distances, as well as to those of major satellites of Jupiter, Saturn and Uranus. The leading assumption was that vacant orbits should be avoided. A radical change in treating the planetary orbits has been made by the separation of terrestrial planets from the Jovian ones. It means that terrestrial planets are considered as an independent system, enjoying the same status as the Jovian group of planets as well as the satellite system of Jupiter, Saturn and Uranus. The division of planets into two groups is justified by their different physical, chemical and dynamical properties [4,6,7]. From a cosmogonical point of view, an explanation could be the following: the centres of aggregation of future planets have been governed by the simple square law. After the accretion process, Jupiter has been formed in the orbit at  $n = 2$ , Saturn at  $n = 3$ , ending with Pluto at  $n = 6$ . The first Jovian protoplanet close to the Sun at  $n = 1$ , has never been formed due to the Sun's thermonuclear reactions. The high-melting-point materials have survived and accreted as the system of terrestrial planets, while the gaseous components have been dispersed due to the solar wind. Only beyond the "temperature limit" of about 200 K, which corresponds to about  $5 \cdot 10^{11}$  m, could the giant Jovian planets exist [4].

The division of planets into two groups appeared also in solving the modified Schrödinger radial equation of the hydrogen-like atom introducing, of course, the gravitational potential [8] and coefficient of diffusion of Brownian motion which characterizes the effect of chaos on large time scales [9a,10]. From a dynamical point of view, the five systems: terrestrial planets, Jovian planets, and satellites of Jupiter, Saturn and Uranus are to a considerable degree adiabatic. Therefore, the relevant equations in the present model include characteristic parameters of the particular system, but they also have a necessary physical generality and consistency. However, many authors [7,11,12] have preferred to treat the spacing of all planets with a single formula, like the Titius-Bode law or its numerous modifications. The authors of this work consider the square law, like that discovered by Bohr in his planetary model of the hydrogen atom, more favourable for an analysis of the planar gravitational systems. Moreover, it has been proposed [13] that the square law of orbital spacing, could be termed the fourth Kepler's law, in the honour of Kepler who searched for a rule of planetary spacing about four centuries ago.

An application of the square law to the extra-solar planetary systems will certainly be examined in the near future. Recently, first attempts [5,10] were made for the three planets of pulsar PSR B 1257+12.

## 2. The model

A discrete distribution of planetary orbits may be obtained by the "quantization" of angular momentum  $J_n$ . Let an orbiting mass be denoted by  $m_n$ , and mass of the central body by  $M$ . Then, using Newton's equation of motion for circular orbits, angular momentum (supposing that  $m_n \ll M$ ) is given by

$$J_n = m_n v_n r_n = m_n \sqrt{GM r_n}, \quad (1)$$

where  $G$  is the gravitational constant,  $r_n$  is the radius of the  $n$ -th orbit and  $v_n$  is the orbital velocity. We assume that angular momentum is "quantized",

$$m_n \sqrt{GM r_n} = n \frac{H}{2\pi}, \quad (2)$$

where  $H$  may be treated as an effective "Planck's gravitational constant", depending on the particular system and even on the particular orbiting body. Equation (2) is not very useful. What one can do is to divide  $H/2\pi$  by the mass of the orbiting body to obtain the "specific Planck's constant"  $H' = H/(2\pi m_n)$  which yields for the orbital radius

$$r_n = \frac{n^2 H'^2}{GM}. \quad (3)$$

$H'$  is also system dependent, but the quantity  $H'/M$  is of the same order of magnitude for all systems (see Table 1, and also Ref. 4). Variability of  $H'/M$  is described by a dimensionless factor  $f$  multiplied by a universal constant  $A$ , i.e.,  $H/(2\pi m_n M) = H'/M = fA$ . Then, Eq. (3) takes the form

$$r_n = \frac{1}{G} (fA)^2 M n^2. \quad (4)$$

We have shown [4] that by comparing electrostatic and gravitational forces, as one possible approach, the constant  $A$  may be defined by the fundamental physical constants as follows:

$$A = 2\pi \frac{G}{\alpha c} = 1.9157 \cdot 10^{-16} \text{ m}^2 \text{ kg}^{-1} \text{ s}^{-1}, \quad (5)$$

where  $\alpha = 2\pi e^2/(4\pi\epsilon_0 \hbar c)$  is the fine-structure constant,  $e$  the charge of an electron,  $\epsilon_0$  the permittivity of vacuum,  $\hbar$  the Planck constant and  $c$  the velocity of light. The dimension of the constant  $A$  is that of angular momentum per square mass, and, in accordance with Eq. (5), the simple proportionality between  $A$  and the Planck constant per square Planck's mass  $m_P = (\hbar c/(2\pi G))^{1/2} = 2.177 \cdot 10^{-8} \text{ kg}$  [9b] is given by

$$A = \frac{\hbar}{\alpha m_P^2}, \quad \text{or} \quad A = \frac{\hbar}{m_0^2}, \quad (6)$$

where  $m_0^2 = \alpha m_P^2$ . A constant analogous to  $A$  has been defined as  $p = 0.8 \cdot 10^{-16} \text{ m}^2 \text{ kg}^{-1} \text{ s}^{-1}$  by Wesson [14] in searching for a clue to a unification of gravitation and particle

physics. Such a constant appeared also in Ref. 1 with the value  $2.35 \cdot 10^{-16} \text{ m}^2 \text{ kg}^{-1} \text{ s}^{-1}$ . Slightly different values of the same constant are due to different initial assumptions.

TABLE 1. Mean values of constants  $r_1$ ,  $H'/M$  and  $f$ , with the assigned values of integers  $n$ , for planetary and satellite systems.

System	$r_1$ (m)	$n$	$H'/M$ ( $\text{m}^2\text{s}^{-1}\text{kg}^{-1}$ )	$f$
Terrestrial planets	$(0.639 \pm 0.016)10^{10}$	3,4,5,6,8	$(0.462 \pm 0.006)10^{-15}$	$2.41 \pm 0.03$
Jovian planets	$(1.751 \pm 0.044)10^{11}$	2,3,4,5,6	$(2.418 \pm 0.030)10^{-15}$	$12.61 \pm 0.16$
Jupiter's satellites	$(4.579 \pm 0.180)10^7$	2,3,4,5,6	$(1.268 \pm 0.025)10^{-15}$	$6.62 \pm 0.13$
Saturn's satellites	$(0.390 \pm 0.012)10^7$	6,7,8,9,10,11	$(0.676 \pm 0.010)10^{-15}$	$3.53 \pm 0.05$
Uranus' satellites	$(0.843 \pm 0.018)10^7$	3,4,5,6,7,8	$(2.542 \pm 0.027)10^{-15}$	$13.27 \pm 0.28$

Using Eqs. (4) and (5), some important parameters of the solar subsystems, the orbital radii  $r_n = r_1 n^2$ , specific angular momenta  $J_n/m_n$ , orbital periods  $T_n$  and velocities  $v_n$  are given by

$$r_n = \left( \frac{2\pi f}{\alpha c} \right)^2 GM n^2, \quad (7)$$

$$\frac{J_n}{m_n} = \left( \frac{2\pi f}{\alpha c} \right) GM n \quad (8),$$

$$T_n = 2\pi \left( \frac{2\pi f}{\alpha c} \right)^3 GM n^3 \quad (9),$$

$$v_n = \frac{1}{2\pi f} \frac{\alpha c}{n}. \quad (10)$$

In Eq. (10),  $\alpha c/n = v_{nH}$  is the orbital velocity of an electron at the  $n$ -th orbit in the Bohr's model of the hydrogen atom, and the term  $1/(2\pi f)$  is a gravitational correction factor. This term is system dependent and it demonstrates that gravitational systems are less regular than analogous electro-dynamical systems.

### 3. Results and discussion

Distributions of specific angular momenta of planets and major satellites according to the linear relationship (Eq. (8)) are illustrated in Fig. 1.

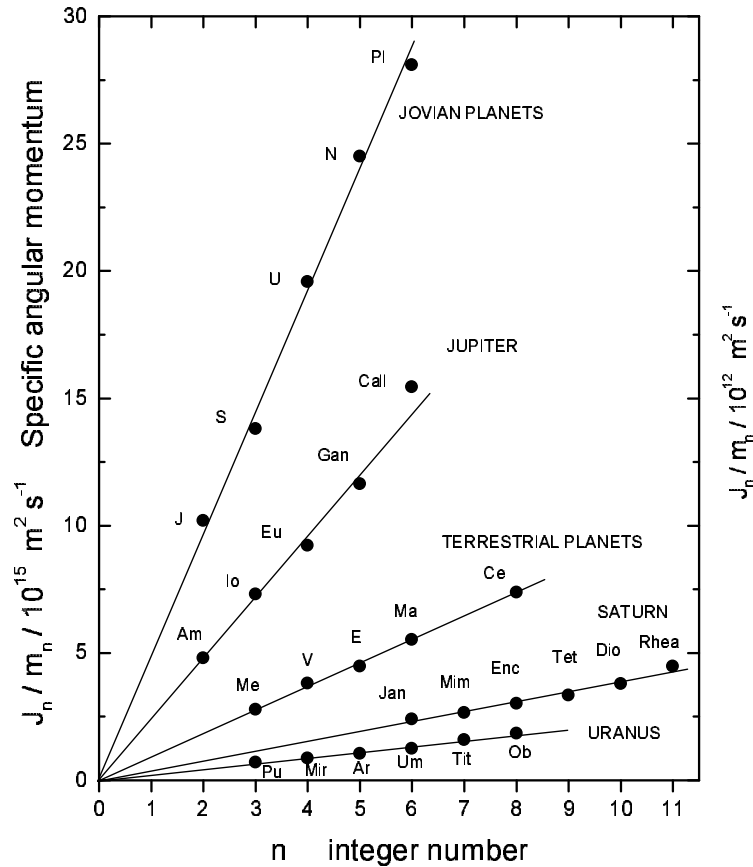

Fig. 1 Specific angular momentum  $J_n/m_n = \sqrt{GM}r_n$  versus the integer number  $n$  for Jovian and terrestrial planets (left scale) and for the major satellites of Jupiter, Saturn and Uranus (right scale).

Discrete values of  $J_n/m_n$  are obtained from Eq. (1) using the observed values of semi-major axes as the mean distances of planets from the Sun, or of satellites from the parent planet, which are taken as the orbital radii  $r_n$  of approximate circular orbits. This introduces small errors of  $r_n$  [4], and of  $J_n/m_n$  for Mercury and Pluto, due to the eccentricities of their orbits of 0.206 and 0.255, respectively [15]. The approximation of circular orbits is very good for other planets and all major satellites. The integer numbers  $n$  are unambiguously determined by the requirement of Eq. (8) that angular momenta are zero at  $n = 0$ , resulting in the straight lines shown in Fig. 1, with no intercepts, as the best fit to the deduced values of  $J_n/m_n$ . The left scale corresponds to Jovian and terrestrial planets, while the right scale is valid for major satellites of Jupiter, Saturn and Uranus. We have also included in our calculations the satellites Amalthea, Janus and Puck (the largest of the small ones), which are near the Roche limit of the parent planets Jupiter, Saturn and Uranus, respectively, and also the largest asteroid Ceres. Therefore, the values of  $r_1$  in the

square law  $r_n = r_1 n^2$  for spacing of planetary orbits in accordance with Eq. (7), and also of  $H'/M$  and  $f$ , which are listed in Table 1, differ slightly from the values given in our earlier work [4]. Note that the orbit of the asteroid Ceres is at  $n = 8$ , which is nearly the center of the Main Belt, whose extension is from  $n = 7$  to  $n = 9$ .

There is one exception in treating the spacing of major satellites. Titan, the largest satellite of Saturn, is not included in the system of smaller satellites from Janus to Rhea. Titan would have the orbit at  $n = 19$  if it were a member of that system. Seven vacant orbits between Rhea and Titan suggest that Titan could be a member of a more extensive system, similarly to Jupiter in the Jovian group of planets in relation to the terrestrial planets. Titan and small satellites Hyperion and Japetus do not form a complete system.

Note that asteroids (except for the largest, Ceres), comets, planetary rings and outer small satellites of planets can not be treated by Eqs. (7-10) because, due to their small masses, a variety of other physical processes (scattering, capture, impacts, planetary perturbations) prevail over the simple law. Moreover, it was recently shown in modeling the massive extrasolar planets, that orbital evolution and significant migration of planets could take place, due to the interaction of a planet with circumstellar disk, with the parent spinning star and also due to the Roche lobe overflow [16]. A planet may move very far from its initial position of formation accompanied also with the loss of mass. However, under certain conditions, planets maintain their position of formation. One may suppose that initial positions are governed by the square law according to the "quantum-mechanical laws", but possible later evolution might be subjected to numerous "effects of classical physics".

We have tried to correlate the factor  $f$  with the ratio of the total mass ( $m_n$  of orbiting bodies to the mass  $M$  of the central body [5], more precisely, of  $f$  with  $(\sum m_n/M)^{1/3}$ . The values of  $f$  for terrestrial planets, Jovian planets and satellites of Jupiter fit very well a straight line, but there are strong deviations of  $f$  for satellites of Saturn, and particularly for those of Uranus. Note that the planes of planetary orbits are close to the ecliptic (except those of Mercury and Pluto) which is also valid for satellites of Jupiter, due to the small inclination of Jupiter's spin axis. However, the satellites of Saturn have an inclination of  $27^\circ$  and those of Uranus  $98^\circ$ . Their satellites have supposedly been formed in the equatorial planes after the protoplanets, within the planetary envelopes, and obtained an additional angular momentum of yet unknown origin. We believe that the deviation of the factor  $f$  from the introduced correlation [5] has the same cause as the change of inclination.

In our later investigation, we have found that reciprocal values of the factor  $f$  take discrete values that may be described by another integer number  $k$ , i.e.,

$$f^{-1} = (0.06753 \pm 0.00085)k + (0.0115 \pm 0.0029), \quad (11)$$

as may be seen in Fig. 2. Therefore, Eq. (10) may be written in the form

$$nv_n = v_1 \approx [(23.5 \pm 0.3)k + (4.0 \pm 1.0)]\text{km s}^{-1}. \quad (12)$$

The product of  $nv_n$ , i.e. the orbital speed  $v_1$  at  $n = 1$  for a particular system, vs.  $n$  is shown in Fig. 3. The values of  $n$  are taken from Table 1, and the mean velocities from observed semimajor axes as  $v_n = (GM/r_n)^{1/2}$  (see

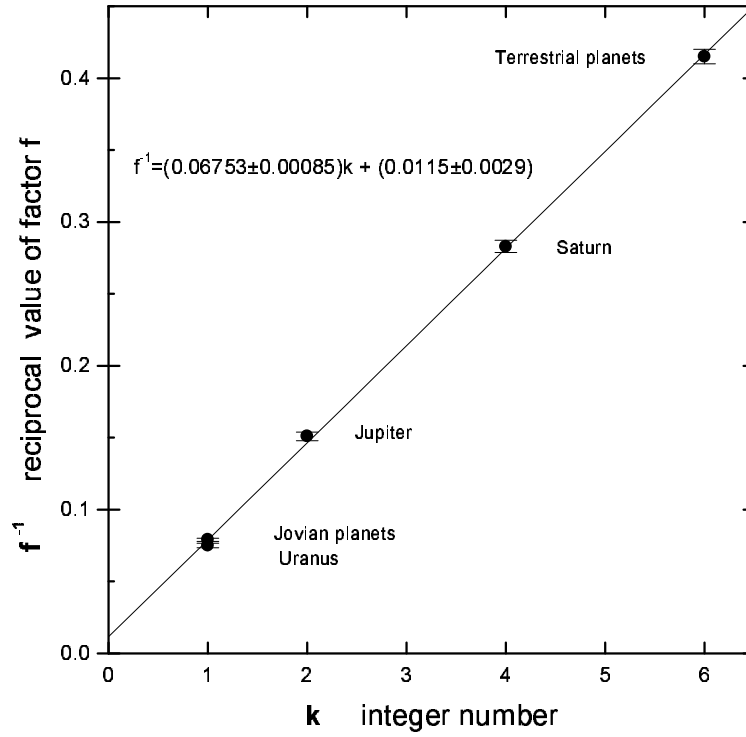

Fig. 2. Correlation of the reciprocal value of the factor  $f$  with integer number  $k$ .

Horizontal lines represent "velocity levels" with spacing define by  $v_0 = 23.5 \text{ km s}^{-1}$  (Eq. (12)). The integer number  $k$  is related to the scale of orbits in a system. It means that a given system can have a series of discrete possible orbital distributions. That is hardly understandable from the standpoints of classical physics, because one can only expect a continuous change of orbital spacing. For example, Uranian satellites are characterized by  $k = 1$ . Neglecting the value of  $f^{-1}$  at  $k = 0$  in Eq. (11), the orbital radii are approximately described by  $r_n = \text{const} \cdot M n^2 / k^2$ . If  $k = 2$ , the orbits would be contracted by the factor four, i.e. contraction of orbits occurs in jumps. Consequently, reduced orbital radii  $r_n/M$  become

$$\frac{r_n}{M} = \frac{G n^2}{v_0^2 k^2} = (1.07 \pm 0.06) \cdot 10^{-19} \frac{n^2}{k^2}, \quad (13)$$

where  $G/v_0^2$  may be called a characteristic length with a dimension  $\text{m kg}^{-1}$ . The value of  $v_0$  in Eq. (13), equal to  $(25.0 \pm 0.7) \text{ km s}^{-1}$  was obtained from the fit of  $f^{-1}$  vs.  $k$  with zero intercept at  $k = 0$ , and neglecting a constant term of velocity  $v_1$  at  $k = 0$  (i.e.,  $4.0 \text{ km s}^{-1}$  in Eq. (12)). That causes a larger error in the calculation of  $r_n$ ,  $v_1$  and of other quantities, but the formulae are simpler in illustrating the main



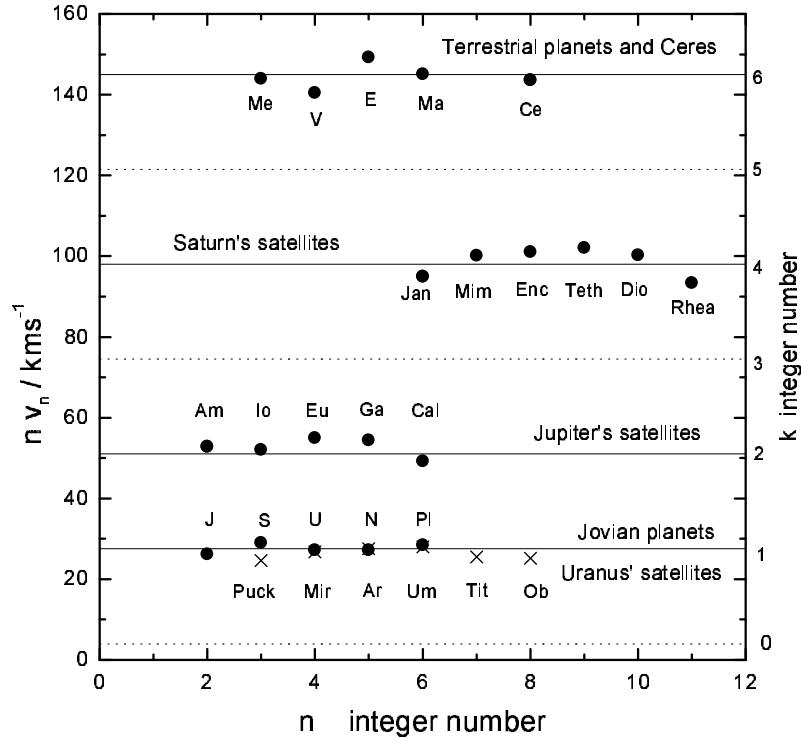

Fig. 3. The product  $nv_n$  of mean orbital velocity  $v_n = \sqrt{GM/r_n}$  and integer number  $n$  versus  $n$  for Jovian and terrestrial planets and for the major satellites of Jupiter, Saturn and Uranus. Integer number  $k$  (right scale) is related to the scaling of orbits. The "velocity levels" are given by Eq. (12).

The orbital integers  $n$  and  $k$  determine the details of possible discrete gravitational structures.

The value of  $v_0 \approx 24 \text{ km s}^{-1}$  has been found as one of increments of the intrinsic galactic redshifts derived from their "quantized" values [17-21]. One may suspect that  $v_0$  is important not only for the Solar System, but that it has a deeper physical meaning to be revealed.

Equation (13) may be rewritten in another important, symmetrical form

$$\frac{r_n}{M} v_0^2 k^2 = \frac{G}{c^2} c^2 n^2. \quad (14)$$

The term  $G/c^2$  is equal to the ratio of the Planck's length  $L_P = (hG/(2\pi c^3))^{1/2}$  and Planck's mass  $m_P = (hc/(2\pi G))^{1/2}$ , i.e.,  $G/c^2 = L_P/m_P$ . Hence, Eq. (14) takes a form

$$\frac{r_n}{M} (kv_0)^2 = \frac{L_P}{m_P} (nc)^2. \quad (15)$$

Equation (15) gives a remarkable connection between macroscopic and microscopic parameters of gravitational systems.

Consider again the initial assumption in our model. The discretization of angular momenta, using the approximation of circular orbits, is given by Eq. (2), i.e.,  $m_n v_n r_n = nH/2\pi$ . The present model permits to write a proper "quantum condition" in accordance with Bohr as

$$m_n v_n r_n \left( \frac{M m_n}{m_0^2} 2\pi f \right)^{-1} = n \frac{h}{2\pi}. \quad (16)$$

An approach to prove Eq. (16), using the theory of similarity, is given in Appendix. Equation (16) can be interpreted as follows: angular momentum of an orbiting body in a planar gravitational system is proportional to the mass  $M$  of the central body and to the mass  $m_n$  of the orbiting body. Therefore, angular momentum per square mass is of special importance. Further multiplication by  $m_0^2 = \alpha m_p^2$  scales a gravitational macroscopic system to the microscopic (atomic) one. However, the ratio  $M m_n / m_0^2$  must be multiplied by the factor  $2\pi f$ , which has to be determined from observational data. Dynamic properties of gravitational systems reach, in the limit, the electrodynamic ones. If the quantities  $r_n = GM/v_n^2$  and  $m_0^2 = h/A$  are introduced in Eq. (16), one easily obtains  $v_n = (2\pi f)^{-1} \alpha c/n$  for the velocity at the  $n$ -th orbit, in accordance with Eq. (10). For  $2\pi f = 1$ , the orbital velocity distribution of the electron in Bohr's hydrogen atom is obtained. It has already been shown that  $n v_n = v_1 = \alpha c / (2\pi f) = k v_0$  (see Fig. 3). For  $k = 1$ , one obtains  $v_0 = 25.0 \text{ km s}^{-1}$ , and consequently, from  $v_0 = \alpha c / (2\pi f_0)$  follows that the maximum value of  $2\pi f$  is  $2\pi f_0 = 87.6 \pm 2.5$ . Orbital radii are then simply given by  $r_n = GM/v_n^2 = (2\pi f_0 / (\alpha c))^2 GM n^2 / k^2$ , which is just Eq. (13). From Eq. (16), an effective "Planck's gravitational constant" appears to be  $H = (2\pi f M m_n / m_0^2) h$ . Then, the Schrödinger's radial wave equation for a gravitational system generates the first orbital radius  $r_1$  in agreement with Eq. (7), as it is shown in Appendix.

The present model describes the structures of planar gravitational systems. It includes three parameters: two integer numbers,  $n$  and  $k$ , and a factor  $f_0$  or velocity  $v_0$ . Eqs. (7-10) may be written in an approximate form as

$$r_n = \frac{1}{v_0^2} GM \frac{n^2}{k^2}, \quad (17)$$

$$\frac{J_n}{m_n} = \frac{1}{v_0} GM \frac{n}{k}, \quad (18)$$

$$T_n = 2\pi \frac{1}{v_0^3} GM \frac{n^3}{k^3}, \quad (19)$$

$$v_n = v_0 \frac{k}{n}. \quad (20)$$

According to Eq. (12),  $n v_n \approx (23.5k + 4.0) \text{ km s}^{-1}$ . Therefore, Eq. (20) deviates from the best fit (Eq. (12)) by the factor  $(1 - 25k / (23.5k + 4.0))$ , i.e. by about 9% if  $k = 1$ , and

by about -3% if  $k = 6$ , while observational mean values of  $nv_n = n(GM/r_n)^{1/2}$  deviate from the best fit (Eq. (12)) less than 2% on the average.

One may criticize the use of many parameters in the model. However, they seem to be necessary, because  $n$  is related to the principal spacing of orbits,  $k$  takes care of the packing of orbits, while  $v_0$  (or  $f_0$ ) characterizes several subsystems within a given system (like our own Solar System). One should not be surprised if in another extra-solar system, the quantity  $v_0$  would take a different value compared with the Solar System. It could possibly be 72, 36, 24, or 18 km s<sup>-1</sup>, as obtained in an analysis of the quantized redshifts of the galaxies [17–20]. For example, the pulsar PSR B 1257+12 has three planets in orbits for  $n$  equal to 5, 7 and 8 [5,10]. From the observational data, one obtains  $nv_n = 410$  km s<sup>-1</sup>, which gives  $k = 17$  for  $v_0 = 24$  km s<sup>-1</sup>. However, if one assumes  $v_0 = 37.3$  km s<sup>-1</sup> (in accordance with Ref. 21, where the interval for redshift periodicity is 37.2 to 37.7 km s<sup>-1</sup>), then  $k$  will be equal to 11. Hopefully, the future investigation of other planetary systems will confirm the ideas proposed in the present model.

## 4. Conclusion

The basis of the square law for the spacing of orbits of planets and of major satellites is the discretization of angular momenta, similarly as in the old Bohr's theory of the hydrogen atom. However, the angular momentum of an orbiting body has to be reduced by the mass of orbiting body and also by the mass of the central body. Moreover, the product of these two masses must also be reduced by square of Planck's mass multiplied by the fine-structure constant  $\alpha$ , in order to scale the macroscopic gravitational system to the microscopic level, where the Planck's reduced constant  $\alpha = h/2\pi$  represents a quantum of angular momentum. As a result of such an approach, two "quantum numbers" appear, the first one  $n$  for describing the law of orbital spacing and the second one  $k$  for the "packing" of the orbits. One further parameter is necessary, that is equal for all systems within the Solar System. It is the characteristic length  $G/v_0^2 = (1.07 \pm 0.06)10^{-19}$  m kg<sup>-1</sup>. But equally well, the third parameter may be a universal velocity  $v_0 \approx 24$  km s<sup>-1</sup>. The three parameters and the mass of the central body (see Eqs. (17-20)) define possible the discrete structures of a planar gravitational system within the approximation of the circular orbits.

Velocity  $v_0$  is equal to the velocity increments of the quantized redshifts of galaxies. A great puzzle is how the planetary orbital velocities can obey the same quantization periods as the intrinsic redshifts of the galaxies.

It is known that some researches do not believe that "quantum phenomena" play any role, both in the formation and in the evolution of the Solar System. They rather suppose that many macroscopic effects have had a predominant influence on planetary spacing. However, in our opinion, the derived results shown in Figs. 1 to 3 strongly suggest the necessity for a certain "quantum mechanical" treatment. As the first approach, the model analogous to the simplest one of the "old quantum mechanics" has been elaborated in the present work. Of course, further observational and theoretical investigations are necessary for the development of more sophisticated models.

### *Acknowledgements*

The authors are grateful to Prof. A. Bjeliš and Prof. K. Pavlovski for their interest and valuable discussions throughout the work and to Prof. H. Arp for his kind comments, suggestions and support.

## *Appendix*

The similarity between the gravitational and Coulomb force between two particles of mass  $m_0$  and charge  $e$  is well known. Moreover, one can imagine that these two forces become identical for adequately chosen mass  $m_0$ . From  $Gm_0^2/r^2 = e^2/(4\pi\epsilon_0r^2)$ , it follows that  $m_0 = (e^2/(4\pi\epsilon_0G))^{1/2} = (\alpha ch/(2\pi G))^{1/2}$ , independently of the mutual distance of particles. The mass  $m_0$  is related to the Planck's mass  $m_P$  by  $m_0 = \alpha^{1/2}m_P = 1.85910^{-9}$  kg. It is reasonable to assume that for such a micro-gravitational system, a quantization of angular momentum of the orbiting body should be the same as the one postulated by Bohr for the electro-dynamical system, i.e.,

$$m_0v_{n0}r_{n0} = n\frac{h}{2\pi}. \quad (A1)$$

For a real macro-gravitational system an analogous discretization could be

$$m_nv_nr_n = n\frac{H}{2\pi}. \quad (A2)$$

To reach a complete similarity between the reference micro-model and a real planetary or satellite system, analogous quantities must be in a constant ratio. These ratios, the so-called similarity constants, such as  $N_m = m_n/m_0$ ,  $N_v = v_n/v_{n0}$  and  $N_r = r_n/r_{n0}$ , must be in definite mutual relationships, which can be generally determined from analogous equations [22]. Thus, Eq. (A1) will transform into Eq. (A2) only with the correlation

$$N_mN_vN_r = N_h = \frac{H}{h}, \quad (A3)$$

which is an indicator of similarity, satisfied for every orbit and for any value of  $n$ . To determine  $H$ , an additional indicator of similarity must be taken into account, which follows from analogous correlations for the forces corresponding to the micro-model and to a system of a body (of mass  $m_n$ ) orbiting the central one (of mass  $M$ ):

$$v_{n0}^2r_{n0} = Gm_0, \quad (A4)$$

$$v_n^2r_n = GM, \quad \text{and} \quad (A5)$$

$$N_v^2N_r = \frac{M}{m_0}. \quad (A6)$$

Introducing the second indicator of similarity (A6) into the first one (A3), one obtains  $H/h = Mm_n/m_0^2N_v$ . Further, from Eqs. (A1) and (A4) for  $m_0 = \alpha^{1/2}m_P$ , it follows

$v_{n0} = \alpha c/n$ , and according to Eq. (10),  $N_v = v_n/v_{n0} = (2\pi f)^{-1}$ . Thus, the effective "Planck's gravitational constant"  $H$  is given by

$$H = h(2\pi f \frac{Mm_n}{m_0^2}), \quad (A7)$$

where the factor  $f$  (see Table 1), determined from astronomical data, is included.

Finally, by introducing Eq. (A7) into Eq. (A2), the scaled "quantum condition" presented by Eq. (16) is proved.

Consequently, Eq. (A7) should be used, e.g., to define a macroscopic "de Broglie wavelength"  $\lambda_n = H/m_n v_n$ . Introducing  $v_n$  from Eq. (10), one obtains  $\lambda_n = 2\pi r_n/n$ , where  $r_n$  is given by Eq. (7). This is an expected result in the present model.  $\lambda_n$  may be transformed into a form dependent on  $n$  and  $k$  as  $\lambda_n = (2\pi/v_0^2)GMn/k^2$  by using Eq. (17). One may also write  $\lambda_n = \lambda_1 n$ , which is an equivalent simple form of the square law  $r_n = r_1 n^2$ .

Equation (A7) allows the use of the Schrödinger's radial wave equation [8] to obtain the orbital spacing. If the gravitational potential  $V(r) = -GMm/r$  and effective "Planck's gravitational constant"  $H$  are introduced into the radial equation, it takes the form

$$\frac{dR}{dr^2} + \frac{2}{r} \frac{dR}{dr} + \frac{8\pi^2 m^2 E'}{H^2} R + \frac{2}{r} \frac{4\pi^2 GMm^2}{H^2} R - \frac{l(l+1)}{r^2} R = 0, \quad (A8)$$

where  $E' = E/m$  is the energy per unit mass of the orbiting body,  $R(r)$  is the radial wave function and  $l$  is the angular quantum number. From the fourth term, "the first Bohr's radius" is

$$r_1 = \frac{H^2}{4\pi^2 GMm^2}. \quad (A9)$$

Introducing  $H$  defined by Eq. (A7), with  $m_n = m$ , one obtains

$$r_1 = \left( \frac{2\pi f}{\alpha c} \right)^2 GM, \quad (A10)$$

which is in agreement with Eq. (7) for  $n = 1$ . If the angular quantum number is limited only to the values  $l = n - 1$ , then the probability maxima of the mass distribution will be at positions given by  $r_n = r_1 n^2$ . Such an approximation has been recently used by Nottale et al. [23]. If all wave functions up to  $n = 10$ , with all possible values of  $l$  are used [8], then the positions of probability maxima slightly deviate from the square law. However, it was already pointed out that the simple approach, related to the old quantum theory is more appropriate for an understanding of gravitational phenomena [24]. Therefore, the complete understanding of the rather formal application of the Schrödinger's equation to the Solar System needs further research.

#### References

- 1) A. G. Agnese and R. Festa, Phys. Lett. A **227** (1997) 165;

- 2) J. J. Lissauer, *Ann. Rev. Astron. Astrophys.* **31** (1993) 129;
- 3) M. de Oliveira Neto, *Ciencia e Cultura*, Journal of the Brazilian Association for the Advancement of Science, **48(3)** (1996) 166;
- 4) A. Rubčić and J. Rubčić, *Fizika* **B 4** (1995) 11;
- 5) A. Rubčić and J. Rubčić, *Fizika* **B 5** (1996) 85;
- 6) H. Alfvén, *Icarus* **3** (1964) 52;
- 7) J. Laskar, *Astron. Astrophys.* **317** (1997) L75;
- 8) N. Qing-xiang, *Acta. Astron. Sinica* **34** (1993) 333;
- 9) L. Nottale, *Fractal Space-Time and Microphysics*, World Scientific Singapore, 1993, a) p. 311, b) p. 187;
- 10) L. Nottale, *Astron. Astrophys.* **315** (1996) L9;
- 11) R. Neuhauser and J. Feitzinger. *Astron. Astrophys.* **170** (1986) 174;
- 12) F. Graner and B. Dubrulle, *Astron. Astrophys.* **282** (1994) 262 and references therein;
- 13) A. Rubčić and J. Rubčić, *EPS 10 Trends in Physics*, September 9-13, 1996, Sevilla, Spain;
- 14) P. S. Wesson, *Phys. Rev.* **D 23** (1981) 1730;
- 15) H. Karttunen, P. Kröger, H. Oja, M. Poutanen and K. J. Donner (Eds), *Fundamental Astronomy*, Springer-Verlag, Berlin, 1996, p.487;
- 16) D. Trilling, W. Benz, T. Guillot, J. I. Lunine, W. B. Hubbard and A. Burrows, *Orbital evolution and migration of giant planets: modeling extrasolar planets*, 1998, *Astrophys. J.* (in press);
- 17) W. G. Tiffit, *Astrophys. J.* **206** (1976) 38;
- 18) W. G. Tiffit and W. J. Cocke, *Astrophys. J.* **287** (1984) 492;
- 19) W. J. Cocke and W. G. Tiffit, *BAAS* **26** (1994) 1409;
- 20) H. Arp and J. W. Sulentic, *Astrophys. J.* 291(1985) 88;
- 21) B. N. G. Guthrie and W. M. Napier, *Astron. Astrophys.* **310** (1996) 353;
- 22) J. Baturić-Rubčić, *J. Phys. E (J. Sci. Instrum.)* **1** (1968) 1090 and *J. Hydr. Res.* **7** (1) (1969) 31;
- 23) L. Nottale, G. Schumacher and J. Gay, *Astron. Astrophys.* **322** (1997) 1018;
- 24) J. Buitrago, *Astrophys. Letters & Comm.* **27** (1988) 1.

# Quantization of Planck Constants and Dark Matter Hierarchy in Biology and Astrophysics

M. Pitkänen

Dept. of Physics, University of Helsinki, Helsinki, Finland.

Email: [matpitka@rock.helsinki.fi](mailto:matpitka@rock.helsinki.fi).

<http://www.helsinki.fi/~matpitka/>.

## Abstract

The work with von Neumann algebras known as hyper-finite factors of type  $II_1$  associated naturally with quantum TGD, led to a proposal for the quantization of the Planck constants associated with the symmetry algebras in  $M^4$  and  $CP_2$  degrees of freedom as  $\hbar(M^4) = n_a \hbar_0$  and  $\hbar(CP_2) = n_b \hbar_0$ . A generalization of the notion of imbedding space emerged as a geometric realization of the quantization in terms of Jones inclusions. As a consequence, also a quantization of the Planck constant appearing in Schrödinger equation emerges and is given by  $\hbar/\hbar_0 = \hbar(M^4)/\hbar(CP_2)$ . "Ruler and compass" integers correspond to a very restricted set of number theoretically preferred values of  $n_a$  and  $n_b$ . In this article the quantization of Planck constant and some of its astrophysical and biological implications are briefly discussed.

## Contents

### 1 Introduction

- 1.1 The model of Nottale and DaRocha
- 1.2 Quantization of Planck constant
  - 1.2.1 Dark matter as macroscopic quantum phase with a gigantic value of Planck constant
  - 1.2.2 Quantization of Planck constants and hyper-finite factors of type  $II_1$
- 1.3 The evolution of the model for planetary system
  - 1.3.1 Understanding the value of the parameter  $v_0$
  - 1.3.2 View about evolution of planetary system

- 1.3.3 Improved predictions for planetary radii and predictions for ratios of planetary masses

## 2 Dark matter hierarchy and quantization of Planck constants

- 2.1 Generalization of the p-adic length scale hypothesis and preferred values of Planck constants
- 2.2 How Planck constants are visible in Kähler action?
- 2.3 Phase transitions changing the level in dark matter hierarchy

## 3 Some astrophysical applications

- 3.1 Bohr quantization of planetary orbits and preferred values of Planck constant
- 3.2 Orbital radii of exoplanets
- 3.3 A more detailed model for planetary system
  - 3.3.1 The interpretation of  $\hbar_{gr}$  and pre-planetary period
  - 3.3.2 Inclinations for the planetary orbits and the quantum evolution of the planetary system
  - 3.3.3 Eccentricities and comets
- 3.4 About the interpretation of the parameter  $v_0$
- 3.5 How do the magnetic flux tube structures and quantum gravitational bound states relate?
  - 3.5.1 The notion of field body
  - 3.5.2  $G_a$  as a symmetry group of field body
  - 3.5.3 Could gravitational Schrödinger equation relate to a quantum control at magnetic flux tubes?
- 3.6 p-Adic length scale hypothesis and  $v_0 \rightarrow v_0/5$  transition at inner-outer border for planetary system

## 4 Some applications to condensed matter and biology

- 4.1 Exceptional groups and structure of water
- 4.2 Aromatic rings and large  $\hbar$  phases
- 4.3 Model for a hierarchy of EEGs

## 5 Summary and outlook

# 1 Introduction

D. Da Rocha and Laurent Nottale, the developer of Scale Relativity, have ended up with an highly interesting quantum theory like model for the evolution of astrophysical systems [2]. In particular, this model applies to



planetary orbits. Nottale predicted Bohr model like quantization for radii of planetary orbits in his book *Fractal Spacetime and Microphysics* published 1993. The quantization was later discovered for exoplanets [1].

### 1.1 The model of Nottale and DaRocha

The model is simply Schrödinger equation with Planck constant  $\hbar$  replaced with what might be called gravitational Planck constant

$$\hbar \rightarrow \hbar_{gr} = \frac{GmM}{v_0} .$$

Here I have used units  $\hbar = c = 1$ .  $v_0$  is a velocity parameter having the value  $v_0 = 144.7 \pm .7$  km/s giving  $v_0/c = 4.6 \times 10^{-4}$ . The peak orbital velocity of stars in galactic halos is  $142 \pm 2$  km/s whereas the average velocity is  $156 \pm 2$  km/s. Also sub-harmonics and harmonics of  $v_0$  seem to appear.

The model makes fascinating predictions which seem to hold true. For instance, the radii of planetary orbits fit nicely with the prediction of the hydrogen atom like model. The inner solar system (Mercury, Venus, Earth, Mars) corresponds to  $v_0$  and outer solar system to  $v_0/5$ .

The predictions for the distribution of major axis and eccentricities have been tested successfully also for exoplanets. Also the periods of 3 planets around pulsar PSR B1257+12 fit with the predictions with a relative accuracy of few hours/per several months. Also predictions for the distribution of stars in the regions where morphogenesis occurs follow from the gravitational Schrödinger equation.

What is important is that there are no free parameters besides  $v_0$ . In [2] a wide variety of astrophysical data is discussed and it seem that the model works and has already now made predictions which have been later verified.

### 1.2 Quantization of Planck constant

In TGD framework [TGDview] the idea about quantized Planck constant emerged originally from a TGD inspired model of topological quantum computation [E9]. Large values of Planck constant would scale up quantal time and length scales and make possible macroscopic quantum phases and thus provide the new physics crucial for quantum models of living matter and conscious brain.

### 1.2.1 Dark matter as macroscopic quantum phase with a gigantic value of Planck constant

Learning about evidence for Bohr quantization of planetary orbits based on a gigantic value of gravitational constant [2, 3] led to the idea that the Bohr orbitology for visible matter might reflect the presence of dark matter characterized by gigantic values of Planck constant and thus in "astroscopic" quantum phase. In a strong contrast with the top-down approach of M-theory, the road to quantum gravity might mimic the much more modest approach leading from hydrogen atom to QED. Just as the Bohr model for hydrogen atom resolved the infrared catastrophe (electron falling into nucleus by emission of radiation), the Bohr model for planetary system could prevent collapse of matter to black hole.

### 1.2.2 Quantization of Planck constants and hyper-finite factors of type II<sub>1</sub>

The infinite-dimensional Clifford algebra of the configuration space of 3-surfaces ("world of classical worlds") corresponds to von Neumann algebra known as hyperfinite factor of type II<sub>1</sub>. The so called Jones inclusions for these algebras led via a sequence of educated guess to the recent proposal for the quantization of Planck constants associated with symmetry algebras of  $M^4$  and  $CP_2$  as integer multiples  $\hbar(M^4) = n_a \hbar_0$  and  $\hbar(CP_2) = n_b \hbar_0$  of the minimal value  $\hbar_0$  of Planck constant.  $n_a$  and  $n_b$  correspond to orders of maximal cyclic subgroups for the discrete subgroups of  $SU(2)$  characterizing these inclusions and the formula follows using anyonic arguments.

A considerable generalization of the notion of imbedding space emerged and a concrete geometric and topological interpretation for how quantum groups characterized by phases  $q_i = \exp(i\pi/n_i)$ ,  $i = 1, b$  are realized in physics. This implies also a model for phase transitions changing the values of Planck constants as a complete or partial leakage of particle 3-surfaces between different sectors of generalized imbedding spaces obtained by gluing together various copies of imbedding space together along common  $M^4$  or  $CP_2$  factor. One can say that two levels of hierarchy are dark relative to each other if they correspond to a different sector of imbedding space.

The basic prediction is that ordinary Planck constant  $\hbar$  appearing in the Schrödinger equation can be expressed as  $\hbar/\hbar_0 = \hbar(M^4)/\hbar(CP_2) = n_a/n_b$  and can in principle have all rational values. Number theoretic considerations however favor what might be called ruler and compass rationals for which  $n_a$  and  $n_b$  define n-polygons constructible using only ruler and com-

pass (the corresponding quantum phases are obtained by iterated square root operation from rationals).

Quantization of Planck constants is equivalent with the scaling of covariant metrics of  $M^4$  *resp.*  $CP_2$  by factor  $n_b^2$  *resp.*  $n_a^2$  followed by over-all scaling by factor  $1/n_a^2$  leaving Kähler action invariant. Hence  $CP_2$  metric remains invariant, and one avoids mathematical difficulties in gluing of various copies of the imbedding space together isometrically.  $M^4$  covariant metric is scaled by  $(n_b/n_a)^2$  meaning that effective Planck constant appearing in Schrödinger equation is  $(n_a/n_b)\hbar_0$ . In this interpretation scaling of Planck constants has a purely geometric meaning.

### 1.3 The evolution of the model for planetary system

A brief summary about the evolution of the model for planetary system is in order.

#### 1.3.1 Understanding the value of the parameter $v_0$

The first observation was that TGD allows to understand the value of the parameter  $v_0/c$  assuming that cosmic strings and their decay remnants are responsible for the dark matter. The number theoretically preferred prediction would be  $v_0 = 2^{-11}$  and expressible in terms of fundamental constants of quantum TGD (Planck length,  $CP_2$  radius, and Kähler coupling strength).

The harmonics of  $v_0$  could be understood as corresponding to perturbations replacing cosmic strings with their  $n$ -branched coverings so that tension becomes  $n^2$ -fold: much like the replacement of a closed orbit with an orbit closing only after  $n$  turns.  $1/n$ -sub-harmonic would result when a magnetic flux tube split into  $n$  disjoint magnetic flux tubes. Also rational multiples of  $v_0$  are possible if both mechanisms operate.

The general formula for  $\hbar_{gr}/\hbar_0$  as ruler and compass rational allowed a more precise prediction for  $v_0$  and led also to a prediction for the ratios of planetary masses as ratios of ruler and compass rationals.

Later a possible interpretation of  $v_0$  as a reduced light velocity emerged. The reduction would be due to the warping of dark space-time sheets meaning that the time component of the induced metric is reduced and one can identify a possible mechanism leading to the warping in the phase transition increasing Planck constant. This effect implies also time dilatation and distinguishes between TGD and General Relativity. These two explanations need not be mutually exclusive.

### 1.3.2 View about evolution of planetary system

The study of inclinations (tilt angles with respect to the Earth's orbital plane) leads to a concrete model for the quantum evolution of the planetary system. Only a stepwise breaking of the rotational symmetry and angular momentum Bohr rules plus Newton's equation (or geodesic equation) are needed, and gravitational Schrödinger equation holds true only inside flux quanta for the dark matter.

a) During pre-planetary period dark matter formed a quantum coherent state on the ( $Z^0$ ) magnetic flux quanta (spherical cells or flux tubes). This made the flux quantum effectively a single rigid body with rotational degrees of freedom corresponding to a sphere or circle (full  $SO(3)$  or  $SO(2)$  symmetry).

b) In the case of spherical shells associated with inner planets the  $SO(3) \rightarrow SO(2)$  symmetry breaking led to the generation of a flux tube with the inclination determined by  $m$  and  $j$  and a further symmetry breaking, kind of an astral traffic jam inside the flux tube, generated a planet moving inside flux tube. The semiclassical interpretation of the angular momentum algebra predicts the inclinations of the inner planets. The predicted (real) inclinations are 6 (7) resp. 2.6 (3.4) degrees for Mercury resp. Venus). The predicted (real) inclination of the Earth's spin axis is 24 (23.5) degrees.

c) The  $v_0 \rightarrow v_0/5$  transition allowing to understand the radii of the outer planets in the model of Da Rocha and Nottale could be understood as resulting from the splitting of ( $Z^0$  and gravi-) magnetic flux tube to five flux tubes representing Earth and outer planets except Pluto, whose orbital parameters indeed differ dramatically from those of other planets. The flux tube has a shape of a disk with a hole glued to the Earth's spherical flux shell.

It is important to notice that effectively a multiplication  $n \rightarrow 5n$  of the principal quantum number is in question. This allows to consider also alternative explanations. Perhaps external gravitational perturbations have kicked dark matter from the orbit or Earth to  $n = 5k$ ,  $k = 2, 3, \dots, 7$  orbits: the fact that the tilt angles for Earth and all outer planets except Pluto (not a planet anymore!) are nearly the same, supports this explanation. Or perhaps there exist at least small amounts of dark matter at all orbits but visible matter is concentrated only around orbits containing some critical amount of dark matter and these orbits satisfy  $n \bmod 5 = 0$  for some reason. TGD based explanation for so called flyby anomaly [6] is based on this assumption [D6].

The rather amazing coincidences between basic bio-rhythms and the pe-

riods associated with the states of orbits in solar system [D6] suggest that the frequencies defined by the energy levels of the gravitational Schrödinger equation might entrain with various biological frequencies such as the cyclotron frequencies associated with the magnetic flux tubes. For instance, the period associated with  $n = 1$  orbit in the case of Sun is 24 hours within experimental accuracy for  $v_0$ .

### 1.3.3 Improved predictions for planetary radii and predictions for ratios of planetary masses

The general prediction for the spectrum of  $\hbar$  as ruler and compass rational gives strong additional constraints but also flexibility since  $\hbar_{gr} = GMm/v_0$  can correspond to ruler and compass integer. The planetary mass ratios can be produced with an accuracy better than 2 per cent assuming that  $\hbar_{gr}/\hbar_0$  is ruler and compass rational.

Ruler and compass hypothesis for allows to improve the fit for the planetary radii in solar system. Also the radii of exoplanets can be fitted with few per cent accuracy (see the section "Orbital radii of exoplanets" and the tables of the Appendix). One cannot hope much more since star masses are deduced theoretically. Moreover the ratios of planetary masses are predicted to be expressible as ratios of ruler and compass rationals and this turns out to be true with 2 per cent accuracy (Table 2). Hence it seems that the hypothesis deserves to be taken seriously. One can even consider the possibility of deducing masses of stars from the orbital radii of exoplanets so that stars models could be tested.

To sum up, it would be too early to say that the proposed model has reached its final form but already at this stage a rich spectrum of predictions follows. It is probably needless to add that the existence of the proposed dark matter hierarchy means that a new period of voyages of discovery to the levels of existence responsible for the special properties of living systems would be waiting for us.

## 2 Dark matter hierarchy and quantization of Planck constants

In this section the quantization of Planck constants in TGD framework is briefly discussed. The detailed discussion can be found in [A9].

The recent geometric interpretation for the quantization of Planck constants is based on Jones inclusions of hyper-finite factors of type  $II_1$  [A9].

a) One can argue that different values of Planck constant correspond to imbedding space metrics involving scalings of  $M^4$  *resp.*  $CP_2$  parts of the metric deduced from the requirement that distances scale as  $\hbar(CP_2)$  *resp.*  $\hbar(M^4)$ . Denoting the Planck constants by  $\hbar(M^4) = n_a \hbar_0$  and  $\hbar(CP_2) = n_b \hbar_0$ , one has that covariant metric of  $M^4$  is proportional to  $n_b^2$  and covariant metric of  $CP_2$  to  $n_a^2$ .

This however leads to difficulties with the isometric gluing of  $CP_2$  factors of different copies of  $H$  together. Kähler action is however invariant under over-all scaling of  $H$  metric so that one can scale it down by  $1/n_a^2$  meaning that  $M^4$  covariant metric is scaled by  $(n_b/n_a)^2$  and  $CP_2$  metric remains invariant and the difficulties in isometric gluing are avoided. This means that if one regards Planck constant as a mere conversion factor, the effective Planck constant scales as  $n_a/n_b$  and Planck constant has a purely geometric meaning as scaling factor of  $M^4$  metric.

In Kähler action only the effective Planck constant  $\hbar_{eff}/\hbar_0 = \hbar(M^4)/\hbar(CP_2)$  appears and by quantum classical correspondence same is true for Schrödinger equation. Elementary particle mass spectrum is also invariant. Same applies to gravitational constant. The alternative assumption that  $M^4$  Planck constant is proportional to  $n_b$  would imply invariance of Schrödinger equation but would not allow to explain Bohr quantization of planetary orbits and would to certain degree trivialize the theory.

b)  $M^4$  and  $CP_2$  Planck constants do not fully characterize a given sector  $M^4_{\pm} \times CP_2$ . Rather, the scaling factors of Planck constant given by the integer  $n$  characterizing the quantum phase  $q = \exp(i\pi/n)$  corresponds to the order of the maximal cyclic subgroup for the group  $G \subset SU(2)$  characterizing the Jones inclusion  $\mathcal{N} \subset \mathcal{M}$  of hyper-finite factors realized as subalgebras of the Clifford algebra of the "world of the classical worlds". This means that subfactor  $\mathcal{N}$  gives rise to  $G$ -invariant configuration space spinors having interpretation as  $G$ -invariant fermionic states.

c)  $G_b \subset SU(2) \subset SU(3)$  defines a covering of  $M^4_{\pm}$  by  $CP_2$  points and  $G_a \subset SU(2) \subset SL(2, C)$  covering of  $CP_2$  by  $M^4_{\pm}$  points with fixed points defining orbifold singularities. Different sectors are glued isometrically together along  $CP_2$  if  $G_b$  is same for them and along  $M^4_{\pm}$  if  $G_a$  is same for them. The degrees of freedom lost by  $G$ -invariance in fermionic degrees of freedom are gained back since the discrete degrees of freedom provided by covering allow many-particle states formed from single particle states realized in  $G$  group algebra. Among other things these many-particle states make possible the notion of N-atom.

d) Phases with different values of scalings of  $M^4$  and  $CP_2$  Planck constants behave like dark matter with respect to each other in the sense that

they do not have direct interactions except at criticality corresponding to a leakage between different sectors of imbedding space glued together along  $M^4$  or  $CP_2$  factors. In large  $\hbar(M^4)$  phases various quantum time and length scales are scaled up which means macroscopic and macro-temporal quantum coherence. In particular, quantum energies associated with classical frequencies are scaled up by a factor  $n_a/n_b$  which is of special relevance for cyclotron energies and phonon energies (superconductivity). For large  $\hbar(CP_2)$  the value of  $\hbar_{eff}$  is small: this leads to interesting physics: in particular the binding energy scale of hydrogen atom increases by the factor  $(n_b/n_a)^2$ .

## 2.1 Generalization of the p-adic length scale hypothesis and preferred values of Planck constants

The evolution in phase resolution in p-adic degrees of freedom corresponds to emergence of algebraic extensions allowing increasing variety of phases  $exp(i\pi/n)$  expressible p-adically. This evolution can be assigned to the emergence of increasingly complex quantum phases and the increase of Planck constant.

One expects that quantum phases  $q = exp(i\pi/n)$  which are expressible using only iterated square root operation are number theoretically very special since they correspond to algebraic extensions of p-adic numbers obtained by an iterated square root operation, which should emerge first. Therefore systems involving these values of  $q$  should be especially abundant in Nature.

These polygons are obtained by ruler and compass construction and Gauss showed that these polygons, which could be called Fermat polygons, have  $n_F = 2^k \prod_s F_{n_s}$  sides/vertices: all Fermat primes  $F_{n_s}$  in this expression must be different. The analog of the p-adic length scale hypothesis emerges since larger Fermat primes are near a power of 2. The known Fermat primes  $F_n = 2^{2^n} + 1$  correspond to  $n = 0, 1, 2, 3, 4$  with  $F_0 = 3$ ,  $F_1 = 5$ ,  $F_2 = 17$ ,  $F_3 = 257$ ,  $F_4 = 65537$ . It is not known whether there are higher Fermat primes.  $n = 3, 5, 15$ -multiples of p-adic length scales clearly distinguishable from them are also predicted and this prediction is testable in living matter. I have already earlier considered the possibility that Fermat polygons could be of special importance for cognition and for biological information processing [H8].

This condition could be interpreted as a kind of resonance condition guaranteing that scaled up sizes for space-time sheets have sizes given by p-adic length scales. The numbers  $n_F$  could take the same role in the evolution of Planck constant assignable with the phase resolution as Mersenne primes

have in the evolution assignable to the p-adic length scale resolution.

## 2.2 How Planck constants are visible in Kähler action?

$\hbar(M^4)$  and  $\hbar(CP_2)$  appear in the commutation and anticommutation relations of various superconformal algebras. Only the ratio  $n_a/n_b$  of  $M^4$  and  $CP_2$  Planck constants appears in Kähler action. This implies that Kähler function codes for radiative corrections to the classical action, which makes possible to consider the possibility that higher order radiative corrections to functional integral vanish as one might expect at quantum criticality. For a given p-adic length scale space-time sheets with all allowed values of Planck constants are possible. Hence the spectrum of quantum critical fluctuations could in the ideal case correspond to the spectrum of  $\hbar$  coding for the scaled up values of Compton lengths and other quantal lengths and times. If so, large  $\hbar$  phases could be crucial for understanding of quantum critical superconductors, in particular high  $T_c$  superconductors.

## 2.3 Phase transitions changing the level in dark matter hierarchy

The identification of the precise criterion characterizing dark matter phase is far from obvious. TGD actually suggests an infinite number of phases which are dark relative to each other in some sense and can transform to each other only via a phase transition which might be called de-coherence or its reversal and which should be also characterized precisely.

A possible solution of the problem comes from the general construction recipe for S-matrix. Fundamental vertices correspond to partonic 2-surfaces representing intersections of incoming and outgoing light-like partonic 3-surfaces.

a) If the characterization of the interaction vertices involves all points of partonic 2-surfaces, they must correspond to definite value of Planck constant and more precisely, definite groups  $G_a$  and  $G_b$  characterizing dark matter hierarchy. Particles of different phases could not appear in the same vertex and a phase transition changing the particles to each other analogous to a de-coherence would be necessary.

b) If transition amplitudes involve only a discrete set of common orbifold points of 2-surface belonging to different sectors then the phase transition between relatively dark matters can be described in terms of S-matrix. It seems that this option is the correct one. In fact, also propagators are essential for the interactions of visible and dark matter and since virtual



elementary particles correspond at space-time level  $CP_2$  type extremals with 4-dimensional  $CP_2$  projection, they cannot leak between different sectors of imbedding space and therefore cannot mediate interactions between different levels of the dark matter hierarchy. This would suggest that the direct interactions between dark and ordinary matter are very weak.

If the matrix elements for real-real partonic transitions involve all or at least a circle of the partonic 2-surface as stringy considerations suggest [C2], then one would have clear distinction between quantum phase transitions and ordinary quantum transitions. Of course, the fact that the points which correspond to zero of Riemann Zeta form only a small subset of points common to real partonic 2-surface and corresponding p-adic 2-surface, implies that the rate for phase transition is in general small. On the other hand, for the non-diagonal S-matrix elements for ordinary transitions would become very small by almost randomness caused by strong fluctuations and the rate for phase transition could begin to dominate.

### 3 Some astrophysical applications

There is considerable support for the Bohr quantization of planetary orbits both in solar system and from exoplanets. The needed gigantic values of gravitational Planck constant can be understood in TGD framework and assigned to dark matter. Theory also predicts preferred ratios for planetary masses and provides a possible interpretation for the velocity parameter characterizing  $\hbar_{gr}$ . The interpretation of the symmetry group  $Z_n$  associated with dark matter can be assigned as broken rotational symmetries of the gravi-magnetic and electric bodies mediating interaction between star and planet. Tiff's quantization of cosmic redshifts can be also understand in this framework. A thorough discussion of this subject can be found at [D6]. Here only a brief summary is given.

#### 3.1 Bohr quantization of planetary orbits and preferred values of Planck constant

The predictions of the generalization of the p-adic length scale hypothesis are consistent with the TGD based model for the Bohr quantization of planetary orbits and some new non-trivial predictions follow.

Since the macroscopic quantum phases with minimum dimension of algebraic extension should be especially abundant in the universe, the natural guess is that the values of the gravitational Planck constant correspond to  $n_F$ -multiples of ordinary Planck constant.

a) The model can explain the enormous values of gravitational Planck constant  $\hbar_{gr}/\hbar_0 = \simeq GMm/v_0 = n_a/n_b$ . The favored values of this parameter should correspond to  $n_{F_a}/n_{F_b}$  so that the mass ratios  $m_1/m_2 = n_{F_{a,1}}n_{F_{b,2}}/n_{F_{b,1}}n_{F_{a,2}}$  for planetary masses should be preferred. The general prediction  $GMm/v_0 = n_a/n_b$  is of course not testable.

b) Nottale [2] has suggested that also the harmonics and subharmonics of  $\lambda$  are possible and in fact required by the model for planetary Bohr orbits (in TGD framework this is not absolutely necessary). The prediction is that favored values of  $n$  should be of form  $n_F = 2^k \prod F_i$  such that  $F_i$  appears at most once. In Nottale's model for planetary orbits as Bohr orbits in solar system  $n = 5$  harmonics appear and are consistent with either  $n_{F,a} \rightarrow F_1 n_{F_a}$  or with  $n_{F,b} \rightarrow n_{F_b}/F_1$  if possible.

	T-B	Bohr <sub>a</sub>	Bohr <sub>b</sub>	Bohr <sub>c</sub>
Planet	$R_{pr}/R$	$[n, R_{pr}/R]$	$[n, R_{pr}/R]$	$[r/s, R_{pr}/R]$
Mercury	1	[3, 1]	[3, 1]	[1,1]
Venus	.93	[4, .95]	[4, .95]	[1,.95]
Earth	.96	[5, 1.08]	[5, 1.08]	[1,1.08]
Mars	1.03	[6, 1.03]	[6, 1.03]	[1,1.03]
Jupiter	.95	[11, .98]	$[2 \times 5, .81]$	[17/15,1.04]
Saturn	1.00	$[3 \times 5, 1.00]$	$[3 \times 5, 1.00]$	[1,1.00]
Uranus	.95	[22, 1.04]	$[4 \times 5, .86]$	[16/15,.98]
Neptune	1.23	[27, 1.03]	$[5 \times 5, .88]$	[17/16,.99]
Pluto	.92	[31, 1.01]	$[6 \times 5, .95]$	[1,.95]

Table 1. The table represents the ratios  $R_{pr}/R$  of predictions  $R_{pr}$  of various models for orbital radii to their experimental average values  $R$ . The first column represents Titius-Bode law (T-B in table). The remaining columns represent variants of Bohr orbit model assuming a) that the principal quantum number  $n$  corresponds to the best possible fit and  $v_0$  has single value, b) assuming the scaling  $v_0 \rightarrow v_0/5$  for outer planets, c) assuming besides  $v_0 \rightarrow v_0/5$  the modification  $v_0 \rightarrow (r/s)v_0$ , where  $r/s$  is ruler and compass rational. The scaling of  $v_0$  is chosen to give complete fit for Mercury.

Table 1 gives the radii of planet for Titius-Bode law and various Bohr orbit models. Not surprisingly, option a) gives the best fit with errors being considerably smaller than the maximal error  $|\Delta R|/R \simeq 1/n$  except for Uranus. The fit given by option b) is poor for Jupiter, Uranus and Saturnus but improves for option c).

The prediction for the ratios of planetary masses can be tested. In the table below are the experimental mass ratios  $r_{exp} = m(pl)/m(E)$ , the best choice of  $r_R = [n_{F,a}/n_{F,b}] * X$ ,  $X$  common factor for all planets, and the ratios  $r_{pred}/r_{exp} = n_{F,a}(planet)n_{F,b}(Earth)/n_{F,a}(Earth)n_{F,b}(planet)$ . The deviations are at most 2 per cent.

<i>planet</i>	<i>Me</i>	<i>V</i>	<i>E</i>	<i>M</i>	<i>J</i>
<i>y</i>	$\frac{2^{13} \times 5}{17}$	$2^{11} \times 17$	$2^9 \times 5 \times 17$	$2^8 \times 17$	$\frac{2^{23} \times 5}{7}$
<i>y/x</i>	1.01	.98	1.00	.98	1.01
<i>planet</i>	<i>S</i>	<i>U</i>	<i>N</i>	<i>P</i>	
<i>y</i>	$2^{14} \times 3 \times 5 \times 17$	$\frac{2^{21} \times 5}{17}$	$\frac{2^{17} \times 17}{3}$	$\frac{2^4 \times 17}{3}$	
<i>y/x</i>	1.01	.98	.99	.99	

Table 2. The table compares the ratios  $x = m(pl)/(m(E))$  of planetary mass to the mass of Earth to prediction for these ratios in terms of integers  $n_F$  associated with Fermat polygons.  $y$  gives the best fit for the allowed factors of the known part  $y$  of the rational  $n_{F,a}/n_{F,b} = yX$  characterizing planet, and the ratios  $y/x$ . Errors are at most 2 per cent.

### 3.2 Orbital radii of exoplanets

Orbital radii of exoplanets serve as a test for the quantization hypothesis. Hundreds of them are already known and in [4] tables listing basic data for for more than one hundred exoplanets can be found. Tables of Appendix provide also references and links to sources giving data about stars, in particular star mass  $M$  using solar mass  $M_S$  as a unit. Hence one can test the formula for the orbital radii given by the expression

$$\frac{r}{r_E} = \frac{n^2}{5^2} \frac{M}{M_S} X . \quad (1)$$

Here the correction factor  $X$  depends on the model.

a)  $X = 1$  corresponds to the prediction of the simplest model allowing only single value of  $v_0$ . It turns out that the simplest option assuming  $X = 1$  fails badly for some planets: the resulting deviations of order 20 per cent typically but in the worst cases the predicted radius is by factor of  $\sim .5$  too small.

b) Nottale [2] has proposed that it is possible to improve the situation by allowing harmonics and sub-harmonics of  $v_0$  which would mean  $X = n^2$

or  $1/n^2$ .

c) In TGD framework general quantization of Planck constant allows  $X$  to be any rational but number theoretical arguments prefer the values of  $X$  which are squares of "ruler and compass" rationals:

$$\begin{aligned} X &= \left(\frac{n_1}{n_2}\right)^2, \\ n_i &= 2^{k_i} \times \prod_{s_i} F_{s_i}, \quad F_{s_i} \in \{3, 5, 17, 257, 2^{16} + 1\}. \end{aligned} \quad (2)$$

Here a given Fermat prime  $F_{s_i}$  can appear only once.

The values of  $X$  used in the fit correspond to  $X \in \{(2/3)^2, (3/4)^2, (4/5)^2, (5/6)^2, (15/17)^2, (15/16)^2, (16/17)^2\} \simeq \{.44, .56, .64, .69, .78, .88, .89\}$  and their inverses. The tables summarizing the resulting fit using both  $X = 1$  and value giving optimal fit are given in the Appendix. The deviations are typically few per cent and one must also take into account the fact that the masses of stars are deduced theoretically using the spectral data from star models. I am not able to form an opinion about the real error bars related to the masses.

### 3.3 A more detailed model for planetary system

The Bohr orbit model for planetary system leads to the idea that the evolution of planetary system could be understood in terms of dark matter. One can also ask whether the inclinations and eccentricities of planetary orbits could be deduced from Bohr orbitology.

#### 3.3.1 The interpretation of $\hbar_{gr}$ and pre-planetary period

$\hbar_{gr}$  could corresponds to a unit of angular momentum for quantum coherent states at magnetic flux tubes or walls containing macroscopic quantum states. Quantitative estimate demonstrates that  $\hbar_{gr}$  for astrophysical objects cannot correspond to spin angular momentum. For Sun-Earth system one would have  $\hbar_{gr} \simeq 10^{77} \hbar$ . This amount of angular momentum realized as a mere spin would require  $10^{77}$  particles! Hence the only possible interpretation is as a unit of orbital angular momentum. The linear dependence of  $\hbar_{gr}$  on  $m$  is consistent with the additivity of angular momenta in the fusion of magnetic flux tubes to larger units if the angular momentum associated with the tubes is proportional to both  $m$  and  $M$ .

Just as the gravitational acceleration is a more natural concept than gravitational force, also  $\hbar_{gr}/m = GM/v_0$  could be more natural unit than

$\hbar_{gr}$ . It would define a universal unit for the circulation  $\oint v \cdot dl$ , which is apart from  $1/m$ -factor equal to the phase integral  $\oint p_\phi d\phi$  appearing in Bohr rules for angular momentum. The circulation could be associated with the flow associated with outer boundaries of magnetic flux tubes surrounding the orbit of mass  $m$  around the central mass  $M \gg m$  and defining light like 3-D CDs analogous to black hole horizons.

The expression of  $\hbar_{gr}$  depends on masses  $M$  and  $m$  and can apply only in space-time regions carrying information about the space-time sheets of  $M$  and the orbit of  $m$ . Quantum gravitational holography suggests that the formula applies at 3-D light like causal determinant (CD)  $X_l^3$  defined by the wormhole contacts gluing the space-time sheet  $X_l^3$  of the planet to that of Sun. More generally,  $X_l^3$  could be the space-time sheet containing the planet, most naturally the magnetic flux tube surrounding the orbit of the planet and possibly containing dark matter in super-conducting state. This would give a precise meaning for  $\hbar_{gr}$  and explain why  $\hbar_{gr}$  does not depend on the masses of other planets.

The simplest option consistent with the quantization rules and with the explanatory role of magnetic flux structures is perhaps the following one.

a)  $X_l^3$  is a torus like surface around the orbit of the planet containing delocalized dark matter. The key role of magnetic flux quantization in understanding the values of  $v_0$  suggests the interpretation of the torus as a magnetic or  $Z^0$  magnetic flux tube. At pre-planetary period the dark matter formed a torus like quantum object. The conditions defining the radii of Bohr orbits follow from the requirement that the torus-like object is in an eigen state of angular momentum in the center of mass rotational degrees of freedom. The requirement that rotations do not leave the torus-like object invariant is obviously satisfied. Newton's law required by the quantum-classical correspondence stating that the orbit corresponds to a geodesic line in general relativistic framework gives the additional condition implying Bohr quantization.

b) A simple mechanism leading to the localization of the matter would have been the pinching of the torus causing kind of a traffic jam leading to the formation of the planet. This process could quite well have involved a flow of matter to a smaller planet space-time sheet  $Y_l^3$  topologically condensed at  $X_l^3$ . Most of the angular momentum associated with torus like object would have transformed to that of planet and situation would have become effectively classical.

c) The conservation of magnetic flux means that the splitting of the orbital torus would generate a pair of Kähler magnetic charges. It is not clear whether this is possible dynamically and hence the torus could still

be there. In fact, TGD explanation for the tritium beta decay anomaly citeTroitsk,Mainz in terms of classical  $Z^0$  force [F8] requires the existence of this kind of torus containing neutrino cloud whose density varies along the torus. This picture suggests that the lacking  $n = 1$  and  $n = 2$  orbits in the region between Sun and Mercury are still in magnetic flux tube state containing mostly dark matter.

d) The fact that  $\hbar_{gr}$  is proportional to  $m$  means that it could have varied continuously during the accumulation of the planetary mass without any effect in the planetary motion: this is of course nothing but a manifestation of Equivalence Principle.

e) It is interesting to look for the scaled up versions of Planck mass  $m_{Pl} = \sqrt{\hbar_{gr}/\hbar} \times \sqrt{\hbar/G} = \sqrt{M_1 M_2/v_0}$  and Planck length  $L_{Pl} = \sqrt{\hbar_{gr}/\hbar} \times \sqrt{\hbar/G} = G\sqrt{M_1 M_2/v_0}$ . For  $M_1 = M_2 = M$  this gives  $m_{Pl} = M/\sqrt{v_0} \simeq 45.6 \times M$  and  $L_{Pl} = r_S/2\sqrt{v_0} \simeq 22.8 \times r_S$ , where  $r_S$  is Schwartzild radius. For Sun  $r_S$  is about 2.9 km so that one has  $L_{Pl} \simeq 66$  km. For a few years ago it was found that Sun contains "inner-inner" core of radius about  $R = 300$  km [11] which is about  $4.5 \times L_{Pl}$ .

### 3.3.2 Inclinations for the planetary orbits and the quantum evolution of the planetary system

The inclinations of planetary orbits provide a test bed for the theory. The semiclassical quantization of angular momentum gives the directions of angular momentum from the formula

$$\cos(\theta) = \frac{m}{\sqrt{j(j+1)}} , \quad |m| \leq j . \quad (3)$$

where  $\theta$  is the angle between angular momentum and quantization axis and thus also that between orbital plane and (x,y)-plane. This angle defines the angle of tilt between the orbital plane and (x,y)-plane.

$m = j = n$  gives minimal value of angle of tilt for a given value of  $n$  of the principal quantum number as

$$\cos(\theta) = \frac{n}{\sqrt{n(n+1)}} . \quad (4)$$

For  $n = 3, 4, 5$  (Mercury, Venus, Earth) this gives  $\theta = 30.0, 26.6,$  and  $24.0$  degrees respectively.

Only the relative tilt angles can be compared with the experimental data. Taking as usual the Earth's orbital plane as the reference the relative tilt angles give what are known as inclinations. The predicted inclinations are 6 degrees for Mercury and 2.6 degrees for Venus. The observed values [12] are 7.0 and 3.4 degrees so that the agreement is satisfactory. If one allows half-odd integer spin the fit is improved. For  $j = m = n - 1/2$  the predictions are 7.1 and 2.9 degrees for Mercury and Venus respectively. For Mars, Jupiter, Saturn, Uranus, Neptune, and Pluto the inclinations are 1.9, 1.3, 2.5, 0.8, 1.8, 17.1 degrees. For Mars and outer planets the tilt angles are predicted to have wrong sign for  $m = j$ . In a good approximation the inclinations vanish for outer planets except Pluto and this would allow to determine  $m$  as  $m \simeq \sqrt{5n(n+1)}/6$ : the fit is not good.

The assumption that matter has condensed from a matter rotating in (x,y)-plane orthogonal to the quantization axis suggests that the directions of the planetary rotation axes are more or less the same and by angular momentum conservation have not changed appreciably. The prediction for the tilt of the rotation axis of the Earth is 24 degrees of freedom in the limit that the Earth's spin can be treated completely classically, that is for  $m = j \gg 1$  in the units used for the quantization of the Earth's angular momentum. What is the value of  $\hbar_{gr}$  for Earth is not obvious (using the unit  $\hbar_{gr} = GM^2/v_0$  the Earth's angular momentum would be much smaller than one). The tilt of the rotation axis of Earth with respect to the orbit plane is 23.5 degrees so that the agreement is again satisfactory. This prediction is essentially quantal: in purely classical theory the most natural guess for the tilt angle for planetary spins is 0 degrees.

The observation that the inner planets Mercury, Venus, and Earth have in a reasonable approximation the predicted inclinations suggest that they originate from a primordial period during which they formed spherical cells of dark matter and had thus full rotational degrees of freedom and were in eigen states of angular momentum corresponding to a full rotational symmetry. The subsequent  $SO(3) \rightarrow SO(2)$  symmetry breaking leading to the formation of torus like configurations did not destroy the information about this period since the information about the value of  $j$  and  $m$  was coded by the inclination of the planetary orbit.

In contrast to this, the dark matter associated with Earth and outer planets up to Neptune formed a flattened magnetic or  $Z^0$  magnetic flux tube resembling a disk with a hole and the subsequent symmetry breaking broke it to separate flux tubes. Earth's spherical disk was joined to the disk formed by the outer planets. The spherical disk could be still present and contain super-conducting dark matter. The presence of this "heavenly sphere" might

closely relate to the fact that Earth is a living planet. The time scale  $T = 2\pi R/c$  is very nearly equal to 5 minutes and defines a candidate for a bio-rhythm.

If this flux tube carried the same magnetic flux as the flux tubes associated with the inner planets, the decomposition of the disk with a hole to 5 flux tubes corresponding to Earth and to the outer planets Mars, Jupiter, Saturn and Neptune, would explain the value of  $v_0$  correctly and also the small inclinations of outer planets. That Pluto would not originate from this structure, is consistent with its anomalously large values of inclination  $i = 17.1$  degrees, small value of eccentricity  $e = .248$ , and anomalously large value of inclination of equator to orbit about 122 degrees as compared to 23.5 degrees in the case of Earth [12].

### 3.3.3 Eccentricities and comets

Bohr-Sommerfeld quantization allows also to deduce the eccentricities of the planetary and comet orbits. One can write the quantization of energy as

$$\frac{p_r^2}{2m_1} + \frac{p_\theta^2}{2m_1 r^2} + \frac{p_\phi^2}{2m_1 r^2 \sin^2(\theta)} - \frac{k}{r} = -\frac{E_1}{n^2} ,$$

$$E_1 = \frac{k^2}{2\hbar_{gr}^2} \times m_1 = \frac{v_0^2}{2} \times m_1 . \quad (5)$$

Here one has  $k = GMm_1$ .  $E_1$  is the binding energy of  $n = 1$  state. In the orbital plane ( $\theta = \pi/2, p_\theta = 0$ ) the conditions are simplified. Bohr quantization gives  $p_\phi = m\hbar_{gr}$  implying

$$\frac{p_r^2}{2m_1} + \frac{k^2 \hbar_{gr}^2}{2m_1 r^2} - \frac{k}{r} = -\frac{E_1}{n^2} . \quad (6)$$

For  $p_r = 0$  the formula gives maximum and minimum radii  $r_\pm$  and eccentricity is given by

$$e^2 = \frac{r_+ - r_-}{r_+} = \frac{2\sqrt{1 - \frac{m^2}{n^2}}}{1 + \sqrt{1 - \frac{m^2}{n^2}}} . \quad (7)$$

For small values of  $n$  the eccentricities are very large except for  $m = n$ . For instance, for  $(m = n - 1, n)$  for  $n = 3, 4, 5$  gives  $e = (.93, .89, .86)$



to be compared with the experimental values (.206, .007, .0167). Thus the planetary eccentricities with Pluto included ( $e = .248$ ) must vanish in the lowest order approximation and must result as a perturbation of the magnetic flux tube.

The large eccentricities of comet orbits might however have an interpretation in terms of  $m < n$  states. The prediction is that comets with small eccentricities have very large orbital radius. Oort's cloud is a system weakly bound to a solar system extending up to 3 light years. This gives the upper bound  $n \leq 700$  if the comets of the cloud belong to the same family as Mercury, otherwise the bound is smaller. This gives a lower bound to the eccentricity of not nearly circular orbits in the Oort cloud as  $e > .32$ .

### 3.4 About the interpretation of the parameter $v_0$

The formula for the gravitational Planck constant contains the parameter  $v_0/c = 2^{-11}$ . This velocity defines the rotation velocities of distant stars around galaxies. The presence of a parameter with dimensions of velocity should carry some important information about the geometry of dark matter space-time sheets. The interpretation in terms of cosmic strings and magnetic flux tubes has been already discussed but also alternative interpretations can be considered.

Velocity like parameters appear also in other contexts. There is evidence for the Tifft's quantization of cosmic red-shifts in multiples of  $v_0/c = 2.68 \times 10^{-5}/3$ : also other units of quantization have been proposed but they are multiples of  $v_0$  [5].

The strange behavior of graphene includes high conductivity with conduction electrons behaving like massless particles with light velocity replaced with  $v_0/c = 1/300$ . The TGD inspired model [J1] explains the high conductivity as being due to the Planck constant  $\hbar(M^4) = 6\hbar_0$  increasing the delocalization length scale of electron pairs associated with hexagonal rings of mono-atomic graphene layer by a factor 6 and thus making possible overlap of electron orbitals. This explains also the anomalous conductivity of DNA containing 5- and 6-cycles [J1].

#### 1. *Is dark matter warped?*

The reduced light velocity could be due to the warping of the space-time sheet associated with dark electrons. TGD predicts besides gravitational red-shift a non-gravitational red-shift due to the warping of space-time sheets possible because space-time is 4-surface rather than abstract 4-manifold. A simple example of everyday life is the warping of a paper sheet: it bends

but is not stretched, which means that the induced metric remains flat although one of its component scales (distance becomes longer along direction of bending). For instance, empty Minkowski space represented canonically as a surface of  $M^4 \times CP_2$  with constant  $CP_2$  coordinates can become periodically warped in time direction because of the bending in  $CP_2$  direction. As a consequence, the distance in time direction shortens and effective light-velocity decreases when determined from the comparison of the time taken for signal to propagate from A to B along warped space-time sheet with propagation time along a non-warped space-time sheet.

The simplest warped imbedding defined by the map  $M^4 \rightarrow S^1$ ,  $S^1$  a geodesic circle of  $CP_2$ . Let the angle coordinate of  $S^1$  depend linearly on time:  $\Phi = \omega t$ .  $g_{tt}$  component of metric becomes  $1 - R^2\omega^2$  so that the light velocity is reduced to  $v_0/c = \sqrt{1 - R^2\omega^2}$ . No gravitational field is present.

The fact that  $M^4$  Planck constant  $n_a\hbar_0$  defines the scaling factor  $n_a^2$  of  $CP_2$  metric could explain why dark matter resides around strongly warped imbeddings of  $M^4$ . The quantization of the scaling factor of  $CP_2$  by  $R^2 \rightarrow n_a^2 R^2$  implies that the initial small warping in the time direction given by  $g_{tt} = 1 - \epsilon$ ,  $\epsilon = R^2\omega^2$ , will be amplified to  $g_{tt} = 1 - n_a^2\epsilon$  if  $\omega$  is not affected in the transition to dark matter phase.  $n_a = 6$  in the case of graphene would give  $1 - x \simeq 1 - 1/36$  so that only a one per cent reduction of light velocity is enough to explain the strong reduction of light velocity for dark matter.

### 2. Is $c/v_0$ quantized in terms of ruler and compass rationals?

The known cases suggests that  $c/v_0$  is always a rational number expressible as a ratio of integers associated with n-polygons constructible using only ruler and compass.

a)  $c/v_0 = 300$  would explain graphene. The nearest rational satisfying the ruler and compass constraint would be  $q = 5 \times 2^{10}/17 \simeq 301.18$ .

b) If dark matter space-time sheets are warped with  $c_0/v = 2^{11}$  one can understand Nottale's quantization for the radii of the inner planets. For dark matter space-time sheets associated with outer planets one would have  $c/v_0 = 5 \times 2^{11}$ .

c) If Tift's red-shifts relate to the warping of dark matter space-time sheets, warping would correspond to  $v_0/c = 2.68 \times 10^{-5}/3$ .  $c/v_0 = 2^5 \times 17 \times 257/5$  holds true with an error smaller than .1 per cent.

### 3. Tift's quantization and cosmic quantum coherence

An explanation for Tift's quantization in terms of Jones inclusions could be that the subgroup  $G$  of Lorentz group defining the inclusion consists of boosts defined by multiples  $\eta = n\eta_0$  of the hyperbolic angle  $\eta_0 \simeq v_0/c$ . This

would give  $v/c = \sinh(n\eta_0) \simeq nv_0/c$ . Thus the dark matter systems around which visible matter is condensed would be exact copies of each other in cosmic length scales since  $G$  would be an exact symmetry. The property of being an exact copy applies of course only in single level in the dark matter hierarchy. This would mean a delocalization of elementary particles in cosmological length scales made possible by the huge values of Planck constant. A precise cosmic analog for the delocalization of electron pairs in benzene ring would be in question.

Why then  $\eta_0$  should be quantized as ruler and compass rationals? In the case of Planck constants the quantum phases  $q = \exp(im\pi/n_F)$  are number theoretically simple for  $n_F$  a ruler and compass integer. If the boost  $\exp(\eta)$  is represented as a unitary phase  $\exp(im\eta)$  at the level of discretely delocalized dark matter wave functions, the quantization  $\eta_0 = n/n_F$  would give rise to number theoretically simple phases. Note that this quantization is more general than  $\eta_0 = n_{F,1}/n_{F,2}$ .

The interpretation in terms of warping would suggest that the dark matter associated with distant stars in the galactic halos moves with a reduced light velocity in a state similar to that of conduction electrons in graphene. The consistency with the interpretation based on magnetic flux quanta remains open.

### 3.5 How do the magnetic flux tube structures and quantum gravitational bound states relate?

In the case of stars in galactic halo the appearance of the parameter  $v_0$  characterizing cosmic strings as orbital rotation velocity can be understood classically. That  $v_0$  appears also in the gravitational dynamics of planetary orbits could relate to the dark matter at magnetic flux tubes. The argument explaining the harmonics and sub-harmonics of  $v_0$  in terms of properties of cosmic strings and magnetic flux tubes identifiable as their descendants strengthens this expectation. As a matter fact, magnetic body corresponds also to gravi-magnetic body since classical gauge fields and gravitational field are very closely related since  $CP_2$  coordinates are primary dynamical variables.

#### 3.5.1 The notion of field body

Topological field quantization implies that one can assign to a material system also field identity, field body. Field body contains both electric and magnetic part and consists of flux quanta of these fields identifiable as space-

time sheets. The notion of magnetic body plays a key role in TGD inspired theory of consciousness being the ultimate intentional agent, experiencer, and performer of bio-control and can have astrophysical size. This does not sound so counter-intuitive if one takes seriously the idea that cognition has p-adic space-time sheets as space-time correlates and that rational points are common to real and p-adic number fields. The point is that infinitesimal in p-adic topology corresponds to infinite in real sense so that cognitive and intentional structures would have literally infinite size.

The magnetic flux tubes carrying various supra phases can be interpreted as special instance of dark energy and dark matter. This suggests a correlation between gravitational self-organization and quantum phases at the magnetic flux tubes and that the gravitational Schrödinger equation somehow relates to the ordinary Schrödinger equation satisfied by the macroscopic quantum phases at magnetic flux tubes. In [A9] I have proposed that the transition increasing Planck constant occurs when perturbation theory fails and thus reduces the higher order radiative corrections. Interestingly, the transition to large Planck constant phase should occur when the masses of interacting is above Planck mass since gravitational self-interaction energy is  $V \sim GM^2/R$ . For the density of water about  $10^3 \text{ kg/m}^3$  the volume carrying a Planck mass correspond to a cube with side  $2.8 \times 10^{-4}$  meters. This corresponds to a volume of a large neuron, which suggests that this phase transition might play an important role in neuronal dynamics.

### 3.5.2 $G_a$ as a symmetry group of field body

The group  $G_a \subset SU(2) \subset SL(2, C)$  appearing in the quantization of Planck constant, means exact rotational symmetry realized in terms of  $M_{\pm}^4$  coverings of  $CP_2$ . The 5- and 6-cycles in biochemistry (sugars, DNA,...) are excellent candidates for these symmetries. For very large values of Planck constant, say for the values  $\hbar(M_{\pm}^4)/\hbar(CP_2) = GMm/v_0 = (n_a/n_b)\hbar_0$ ,  $v_0 = 2^{-11}$ , required by the model for planetary orbits as Bohr orbits [D6],  $G_a$  is huge and corresponds to either  $Z_{n_a}$  or in the case of even value of  $n_a$  to the group generated by  $Z_n$  and reflection acting on plane and containing  $2n_a$  elements.

The notion of field body, in particular magnetic body, seems to provide the only conceivable candidate for a geometric object possessing  $G_a$  as symmetries. In the first approximation the magnetic field associated with a dark matter system is expected to be modellable as a dipole field having rotational symmetry around the dipole axis. Topological quantization means that this field decomposes into flux tube like structures related by the rotations of  $Z_n$

or  $D_{2n}$ . Dark particles would have wave functions delocalized to this set of these flux quanta and span group algebra of  $G_a$ . Note that electric body as a structure consisting of radial electric flux tubes makes also sense and can possess  $G_a$  as a symmetry.

Magnetic and electric flux quanta would naturally mediate gravi-magnetic and -electric interactions in the TGD based model for the quantization of radii of planetary orbits and this explains the dependence of  $\hbar_{gr}$  on the masses of planet and central object [D6].

### 3.5.3 Could gravitational Schrödinger equation relate to a quantum control at magnetic flux tubes?

An infinite self hierarchy is the basic prediction of TGD inspired theory of consciousness ("everything is conscious and consciousness can be only lost"). Topological quantization allows to assign to any material system a field body as the topologically quantized field pattern created by the system [L4, K1]. This field body can have an astrophysical size and would utilize the material body as a sensory receptor and motor instrument.

Magnetic flux tube and flux wall structures are natural candidates for the field bodies. Various empirical inputs have led to the hypothesis that the magnetic flux tube structures define a hierarchy of magnetic bodies, and that even Earth and larger astrophysical systems possess magnetic body which makes them conscious self-organizing living systems. In particular, life at Earth would have developed first as a self-organization of the superconducting dark matter at magnetic flux tubes [L4].

For instance, EEG frequencies corresponds to wavelengths of order Earth size scale and the strange findings of Libet about time delays of conscious experience [13, 14] find an elegant explanation in terms of time taken for signals propagate from brain to the magnetic body [K1]. Cyclotron frequencies, various cavity frequencies, and the frequencies associated with various p-adic frequency scales are in a key role in the model of bio-control performed by the magnetic body. The cyclotron frequency scale is given by  $f = eB/m$  and rather low as are also cavity frequencies such as Schumann frequencies: the lowest Schumann frequency is in a good approximation given by  $f = 1/2\pi R$  for Earth and equals to 7.8 Hz.

#### 1. Quantum time scales as "bio-rhythms" in solar system?

To get some idea about the possible connection of the quantum control possibly performed by the dark matter with gravitational Schrödinger equation, it is useful to look for the values of the periods defined by the

gravitational binding energies of test particles in the fields of Sun and Earth and look whether they correspond to some natural time scales. For instance, the period  $T = 2GM_S n^2 / v_0^3$  defined by the energy of  $n^{\text{th}}$  planetary orbit depends only on the mass of Sun and defines thus an ideal candidate for a universal "bio-rhythm".

For Sun black hole radius is about 2.9 km. The period defined by the binding energy of lowest state in the gravitational field of Sun is given  $T_S = 2GM_S / v_0^3$  and equals to 23.979 hours for  $v_0/c = 4.8233 \times 10^{-4}$ . Within experimental limits for  $v_0/c$  the prediction is consistent with 24 hours! The value of  $v_0$  corresponding to exactly 24 hours would be  $v_0 = 144.6578$  km/s (as a matter fact, the rotational period of Earth is 23.9345 hours). As if as the frequency defined by the lowest energy state would define a "biological" clock at Earth! Mars is now a strong candidate for a seat of life and the day in Mars lasts 24hr 37m 23s!  $n = 1$  and  $n = 2$  are orbitals are not realized in solar system as planets but there is evidence for the  $n = 1$  orbital as being realized as a peak in the density of IR-dust [2]. One can of course consider the possibility that these levels are populated by small dark matter planets with matter at larger space-time sheets. Bet as it may, the result supports the notion of quantum gravitational entrainment in the solar system.

The slower rhythms would become as  $n^2$  sub-harmonics of this time scale. Earth itself corresponds to  $n = 5$  state and to a rhythm of .96 hours: perhaps the choice of 1 hour to serve as a fundamental time unit is not merely accidental. The magnetic field with a typical ionic cyclotron frequency around 24 hours would be very weak: for 10 Hz cyclotron frequency in Earth's magnetic field the field strength would about  $10^{-11}$  T. However,  $T = 24$  hours corresponds with 6 per cent accuracy to the p-adic time scale  $T(k = 280) = 2^{13}T(2, 127)$ , where  $T(2, 127)$  corresponds to the secondary p-adic time scale of .1 s associated with the Mersenne prime  $M_{127} = 2^{127} - 1$  characterizing electron and defining a fundamental bio-rhythm and the duration of memetic codon [TGDgame].

Comorosan effect [15, J5] demonstrates rather peculiar looking facts about the interaction of organic molecules with visible laser light at wavelength  $\lambda = 546$  nm. As a result of irradiation molecules seem to undergo a transition  $S \rightarrow S^*$ .  $S^*$  state has anomalously long lifetime and stability in solution.  $S \rightarrow S^*$  transition has been detected through the interaction of  $S^*$  molecules with different biological macromolecules, like enzymes and cellular receptors. Later Comorosan found that the effect occurs also in non-living matter. The basic time scale is  $\tau = 5$  seconds. p-Adic length scale hypothesis does not explain  $\tau$ , and it does not correspond to any obvious astrophysical time scale and has remained a mystery.

The idea about astro-quantal dark matter as a fundamental bio-controller inspires the guess that  $\tau$  could correspond to some Bohr radius  $R$  for a solar system via the correspondence  $\tau = R/c$ . As observed by Nottale,  $n = 1$  orbit for  $v_0 \rightarrow 3v_0$  corresponds in a good approximation to the solar radius and to  $\tau = 2.18$  seconds. For  $v_0 \rightarrow 2v_0$   $n = 1$  orbit corresponds to  $\tau = AU/(4 \times 25) = 4.992$  seconds: here  $R = AU$  is the astronomical unit equal to the average distance of Earth from Sun. The deviation from  $\tau_C$  is only one per cent and of the same order of magnitude as the variation of the radius for the orbit due to orbital eccentricity  $(a - b)/a = .0167$  [12].

## 2. Earth-Moon system

For Earth serving as the central mass the Bohr radius is about 18.7 km, much smaller than Earth radius so that Moon would correspond to  $n = 147.47$  for  $v_0$  and  $n = 1.02$  for the sub-harmonic  $v_0/12$  of  $v_0$ . For an aficionado of cosmic jokes or a numerologist the presence of the number of months in this formula might be of some interest. Those knowing that the Mayan calendar had 11 months and that Moon is receding from Earth might rush to check whether a transition from  $v/11$  to  $v/12$  state has occurred after the Mayan culture ceased to exist: the increase of the orbital radius by about 3 per cent would be required! Returning to a more serious mode, an interesting question is whether light satellites of Earth consisting of dark matter at larger space-time sheets could be present. For instance, in [L4] I have discussed the possibility that the larger space-time sheets of Earth could carry some kind of intelligent life crucial for the bio-control in the Earth's length scale.

The period corresponding to the lowest energy state is from the ratio of the masses of Earth and Sun given by  $M_E/M_S = (5.974/1.989) \times 10^{-6}$  given by  $T_E = (M_E/M_S) \times T_S = .2595$  s. The corresponding frequency  $f_E = 3.8535$  Hz frequency is at the lower end of the theta band in EEG and is by 10 per cent higher than the p-adic frequency  $f(251) = 3.5355$  Hz associated with the p-adic prime  $p \simeq 2^k$ ,  $k = 251$ . The corresponding wavelength is 2.02 times Earth's circumference. Note that the cyclotron frequencies of Nn, Fe, Co, Ni, and Cu are 5.5, 5.0, 5.2, 4.8 Hz in the magnetic field of  $.5 \times 10^{-4}$  Tesla, which is the nominal value of the Earth's magnetic field. In [M4] I have proposed that the cyclotron frequencies of Fe and Co could define biological rhythms important for brain functioning. For  $v_0/12$  associated with Moon orbit the period would be 7.47 s: I do not know whether this corresponds to some bio-rhythm.

It is better to leave for the reader to decide whether these findings support the idea that the super conducting cold dark matter at the magnetic

flux tubes could perform bio-control and whether the gravitational quantum states and ordinary quantum states associated with the magnetic flux tubes couple to each other and are synchronized.

### 3.6 p-Adic length scale hypothesis and $v_0 \rightarrow v_0/5$ transition at inner-outer border for planetary system

$v_0 \rightarrow v_0/5$  transition would allow to interpret the orbits of outer planets as  $n \geq 1$  orbits. The obvious question is whether inner to outer zone as  $v_0 \rightarrow v_0/5$  transition could be interpreted in terms of the p-adic length scale hierarchy [E5, TGDpad].

a) The most important p-adic length scale are given by primary p-adic length scales  $L(k) = 2^{(k-151)/2} \times 10$  nm and secondary p-adic length scales  $L(2, k) = 2^{k-151} \times 10$  nm,  $k$  prime.

b) The p-adic scale  $L(2, 139) = 114$  Mkm is slightly above the orbital radius 109.4 Mkm of Venus. The p-adic length scale  $L(2, 137) \simeq 28.5$  Mkm is roughly one half of Mercury's orbital radius 57.9 Mkm. Thus strong form of p-adic length scale hypothesis could explain why the transition  $v_0 \rightarrow v_0/5$  occurs in the region between Venus and Earth ( $n = 5$  orbit for  $v_0$  layer and  $n = 1$  orbit for  $v_0/5$  layer).

c) Interestingly, the *primary* p-adic length scales  $L(137)$  and  $L(139)$  correspond to fundamental atomic length scales which suggests that solar system be seen as a fractally scaled up "secondary" version of atomic system.

d) Planetary radii have been fitted also using Titius-Bode law predicting  $r(n) = r_0 + r_1 \times 2^n$ . Hence one can ask whether planets are in one-one correspondence with primary and secondary p-adic length scales  $L(k)$ . For the orbital radii 58, 110, 150, 228 Mkm of Mercury, Venus, Earth, and Mars indeed correspond approximately to  $k = 276, 278, 279, 281$ : note the special position of Earth with respect to its predecessor. For Jupiter, Saturn, Uranus, Neptune, and Pluto the radii are 52, 95, 191, 301, 395 Mkm and would correspond to p-adic length scales  $L(280 + 2n)$ ,  $n = 0, \dots, 3$ . Obviously the transition  $v_0 \rightarrow v_0/5$  could occur in order to make the planet-p-adic length scale one-one correspondence possible.

e) It is interesting to look whether the p-adic length scale hierarchy applies also to the solar structure. In a good approximation solar radius .696 Mkm corresponds to  $L(270)$ , the lower radius .496 Mkm of the convective zone corresponds to  $L(269)$ , and the lower radius .174 Mkm of the radiative zone (radius of the solar core) corresponds to  $L(266)$ . This encourages the hypothesis that solar core has an onion like sub-structure corresponding to various p-adic length scales. In particular,  $L(2, 127)$  ( $L(127)$ ) corresponds



to electron) would correspond to 28 Mm. The core is believed to contain a structure with radius of about 10 km: this would correspond to  $L(231)$ . This picture would suggest universality of star structure in the sense that stars would differ basically by the number of the onion like shells having standard sizes.

Quite generally, in TGD Universe the formation of join along boundaries bonds is the space-time correlate for the formation of bound states. This encourages to think that ( $Z^0$ ) magnetic flux tubes are involved with the formation of gravitational bound states and that for  $v_0 \rightarrow v_0/k$  corresponds either to a splitting of a flux tube resembling a disk with a whole to  $k$  pieces, or to the scaling down  $B \rightarrow B/k^2$  so that the magnetic energy for the flux tube thickened and stretched by the same factor  $k^2$  would not change.

## 4 Some applications to condensed matter and biology

Dark matter hierarchy has a wide spectrum of biological applications. Examples are a model for high  $T_c$  super-conductivity as a quantum critical phenomenon involving phases with different values of Planck constant [J1, J2, J3], a model for a hierarchy of EEGs based on the model of super-conductivity and on the notion of dark magnetic body [M3, F9, J6], the notion of dark "N-atoms" ( $N$  corresponds to number of sheets in multiple covering of  $CP_2$  by  $M^4$  points suggesting how symbolic representations and language like structures emerge already at the level of bio-molecules [F9, L2, J6].

Planck constant can have also values smaller than ordinary Planck constant given in terms of ruler and compass rationals. Hydrinos (hydrogen atoms with fractional principal quantum number) reported by Mills [10] could be understood in this framework [A9]. In this model the states with fractional principal quantum number predicted by q-Laquerre equation [A9] would serve as intermediate states for transitions to dark matter phase. Here only two examples are briefly discussed.

### 4.1 Exceptional groups and structure of water

By McKay correspondence finite subgroups of  $SU(2)$  correspond to subset of ADE groups which has led to a proposal that TGD could be able to mimic corresponding gauge theories using the states of group algebras of finite sub-groups. The Dynkin diagrams of exceptional Lie groups  $E_6$  and  $E_8$

correspond to exceptional subgroups of rotation group in the sense that they cannot be reduced to symmetry transformations of plane. They correspond to the symmetry group  $S_4 \times Z_2$  of tetrahedron and  $A_5 \times Z_2$  of dodecahedron or its dual polytope icosahedron ( $A_5$  is 60-element subgroup of  $S_5$  consisting of even permutations). Maximal cyclic subgroups are  $Z_4$  and  $Z_5$  and thus their orders correspond to Fermat polygons. Interestingly,  $n = 5$  corresponds to minimum value of  $n$  making possible topological quantum computation using braids and also to Golden Mean.

There is evidence for an icosahedral clustering in water [7]. Synaptic contacts contain clathrin molecules which are truncated icosahedrons and form lattice structures and are speculated to be involved with quantum computation like activities possibly performed by microtubules. Many viruses have the shape of icosahedron. One can ask whether these structures could be formed around templates formed by dark matter corresponding to 120-fold covering of  $CP_2$  points by  $M_{\pm}^4$  points and having  $\hbar(CP_2) = 5\hbar_0$  perhaps corresponding color confined light dark quarks. Of course, a similar covering of  $M_{\pm}^4$  points by  $CP_2$  could be involved.

## 4.2 Aromatic rings and large $\hbar$ phases

Aromatic rings contain odd number of  $\pi$  delocalized electron pairs with atoms in the same plane. The delocalization of  $\pi$  electrons in the ring is used to explain the stability of these compounds [8]. Benzene is the classical example of this kind of structure. Delocalization and anomalous DNA conductivity [9] suggest interpretation in terms  $n_a = 5$  or  $n_a = 6$  phase (note that these integers correspond to ruler and compass polygons). DNA conductivity would result from overlap of electrons between rings along DNA strand. Delocalization might give also rise to Cooper pairs [J1].

Aromatic rings consisting of 5 or 6 carbons are very common in biology. DNA basis have been already mentioned. Carbohydrates consist of monosaccharide sugars of which most contain aromatic ring (glucose used as metabolic fuel are exception). Monoamine neurotransmitters are neurotransmitters and neuromodulators that contain one amino group that is connected to an aromatic ring by a two-carbon chain (-CH<sub>2</sub>-CH<sub>2</sub>-). The neurotransmitters known a monoamines are derived from the four aromatic amino acids phenylalanine, tyrosine, histidine, tryptophan. Also norepinephrine, dopamine, and serotonin involve aromatic rings As a rule psychoactive drugs involve aromatic rings: for instance, LSD contains four rings.

These observations inspire the question whether the compounds containing aromatic rings serve as junctions connecting pre- and postsynaptic

neurons and induce Josephson currents between them. If Josephson radiation codes for the mental images communicated to the magnetic body, the psychoactive character of these compounds could be understood. One can also ask whether these compounds induce quantum criticality making possible generation of large  $\hbar$  phases?

### 4.3 Model for a hierarchy of EEGs

For the model of dark matter hierarchy appearing in the model of living matter one has  $n_a = 2^{11k}$ ,  $k = 1, 2, 3, \dots, 7$  for cyclotron time scales below life cycle for a magnetic field  $B_d = .2$  Gauss at  $k = 4$  level of hierarchy (the field strength is fixed by the model for the effects of ELF em fields on vertebrate brain at harmonics of cyclotron frequencies of biologically important ions [M3]). Note that  $B_d$  scales as  $2^{-11k}$  from the requirement that cyclotron energy is constant.

A successful model of EEG emerges explaining its band structure and narrow resonances inside bands. EEG can be interpreted in terms of communications from cell membrane to magnetic body using dark Josephson radiation and the control of genome by magnetic body using dark cyclotron radiation. DNA strands would be organized at magnetic flux sheets like lines of text on a page of book. Super-genome would code coherent gene expression at the level of organs and hyper-genome containing super-genomes of different organisms as text lines would be responsible for coherent gene expression at the level of populations.

The hierarchical structure of magnetic body implies a hierarchy of EEGs and ordinary EEG corresponds to a magnetic body with size of order Earth from Compton length of EEG photons. The large value of  $\hbar$  guarantees that dark EEG photons are above thermal threshold and therefore not masked by the thermal noise. Great leaps in evolution would naturally correspond to an emergence of a new level in dark matter hierarchy at the level of individual organism.

The not easily acceptable general prediction is that the field bodies associated with living matter would have sizes up to light life. On the other hand, Libet's findings about strange time delays of consciousness can be understood in terms of magnetic body of size of order Earth.

## 5 Summary and outlook

The predicted dark matter hierarchy means giving up the reductionistic world view. Fractality and possibility to use simple scaling arguments

makes this vision highly predictive and testable. Of course, a lot remains to be understood. For instance, it is not yet clear whether the two interpretations of the parameter  $v_0$  appearing in the model of planetary orbits are mutually consistent.

The new view has also implications for elementary particle -, nuclear -, and condensed matter physics [F8, F9, J6, J1, J2, J3]. Darkness of valence quarks could allow improved understanding of color confinement. Dark variants of electro-weak gauge bosons and gluons with zoomed up Compton wave length might be directly relevant to the understanding of even ordinary condensed matter [F9]. High  $T_c$  super-conductivity represents one particular condensed matter application in which zoomed up electrons play a role [J1].

Perhaps the most fascinating applications of the theory would be to living systems and to quantum model of brain. For instance, I have proposed that charge entanglement over macroscopic distances made possible by dark  $W$  bosons might be a fundamental mechanism in quantum control in living matter.

### Acknowledgements

I am grateful for Victor Christianto for informing me about the evidence for the quantization of radii of planetary orbits.

### References

- [TGDview] M. Pitkänen (2006), *Topological Geometrodynamics: Overview*.  
<http://www.helsinki.fi/~matpitka/tgdview/tgdview.html>.
- [TGDgeom] M. Pitkänen (2006), *Quantum Physics as Infinite-Dimensional Geometry*.  
<http://www.helsinki.fi/~matpitka/tgdgeom/tgdgeom.html>.
- [TGDquant] M. Pitkänen (2006), *Quantum TGD*.  
<http://www.helsinki.fi/~matpitka/tgdquant/tgdquant.html>.
- [TGDclass] M. Pitkänen (2006), *Physics in Many-Sheeted Space-Time*.  
<http://www.helsinki.fi/~matpitka/tgdclass/tgdclass.html>.
- [TGDnumber] M. Pitkänen (2006), *TGD as a Generalized Number Theory*.  
<http://www.helsinki.fi/~matpitka/tgdnumber/tgdnumber.html>.

- [TGDpad] M. Pitkänen (2006), *p-Adic length Scale Hypothesis and Dark Matter Hierarchy*.  
<http://www.helsinki.fi/~matpitka/paddark/paddark.html>.
- [TGDfree] M. Pitkänen (2006), *TGD and Fringe Physics*.  
<http://www.helsinki.fi/~matpitka/freenergy/freenergy.html>.
- [TGDconsc] M. Pitkänen (2006), *TGD Inspired Theory of Consciousness*.  
<http://www.helsinki.fi/~matpitka/tgdconsc/tgdconsc.html>.
- [TGDselforg] M. Pitkänen (2006), *Bio-Systems as Self-Organizing Quantum Systems*.  
<http://www.helsinki.fi/~matpitka/bioselforg/bioselforg.html>.
- [TGDware] M. Pitkänen (2006), *Quantum Hardware of Living Matter*.  
<http://www.helsinki.fi/~matpitka/bioware/bioware.html>.
- [TGDholo] M. Pitkänen (2006), *Bio-Systems as Conscious Holograms*.  
<http://www.helsinki.fi/~matpitka/hologram/hologram.html>.
- [TGDgeme] M. Pitkänen (2006), *Mathematical Aspects of Consciousness Theory*.  
<http://www.helsinki.fi/~matpitka/genememe/genememe.html>.
- [TGDdeeg] M. Pitkänen (2006), *TGD and EEG*.  
<http://www.helsinki.fi/~matpitka/tgdeeg/tgdeeg/tgdeeg.html>.
- [TGDmagn] M. Pitkänen (2006), *Magnetospheric Consciousness*.  
<http://www.helsinki.fi/~matpitka/magnconsc/magnconsc.html>.
- [TGDmath] M. Pitkänen (2006), *Mathematical Aspects of Consciousness Theory*.  
<http://www.helsinki.fi/~matpitka/mathconsc/mathconsc.html>.
- [1] L. Nottale (1993), *Fractal Space-Time and Microphysics*, World Scientific.
- [2] D. Da Roacha and L. Nottale (2003), *Gravitational Structure Formation in Scale Relativity*, astro-ph/0310036.
- [3] A. Rubric and J. Rubric (1998), *The Quantization of the Solar-like Gravitational Systems*, Fizika B7, 1, 1-13.  
 Idid (1999), *Square Law for Orbits in Extra-solar Planetary Systems*, Fizika A 8, 2, 45-50.

- [4] *Masses and Orbital Characteristics of Extrasolar Planets using stellar masses derived from Hipparcos, metalicity, and stellar evolution*, <http://exoplanets.org/almanacframe.html>.
- [5] William G. Tifft (1976), *Discrete States Of Redshift And Galaxy Dynamics I*, *Astrophysical Journal*, Vol. 206:38-56, 15 May, 1976.  
 Ibid (1982), *Quantum Effects In The Redshift Intervals For Double Galaxies*, *Astrophysical Journal*, Vol. 257:442-499, 15 June.  
 Ibid (1982), *Double Galaxy Investigations II*, *Astrophysical Journal*, Vol. 262:44-47, 1 November.
- [6] J. D. Anderson *et al*(2006), *The energy Transfer Process in Planetary Flybys*, astro-ph/0608087.
- [7] M. Chaplin (2006), *Water as a Network of Icosahedral Water Clusters*, <http://www.lsbu.ac.uk/water/clusters.html>.
- [8] *Aromaticity*.  
[http://en.wikipedia.org/wiki/Aromatic\\_rings](http://en.wikipedia.org/wiki/Aromatic_rings).
- [9] *Science* (1997), vol. 275, 7. March 1997. An article about the work of Barton *et al* giving support for the ability of DNA to act as a conductor.
- [10] R. Mills *et al*(2003), *Spectroscopic and NMR identification of novel hybrid ions in fractional quantum energy states formed by an exothermic reaction of atomic hydrogen with certain catalysts*.  
<http://www.blacklightpower.com/techpapers.html> .
- [11] BBC NEWS Science/Nature (2002), *Quakes reveal 'core within a core'*, Wednesday, 2 October,  
<http://news.bbc.co.uk/1/hi/sci/tech/2290551.stm> .
- [12] <http://hyperphysics.phy-astr.gsu.edu/hbase/solar/soldata2.html>.
- [13] S. Klein (2002), *Libet's Research on Timing of Conscious Intention to Act: A Commentary* of Stanley Klein, *Consciousness and Cognition* 11, 273-279.  
[http://cornea.berkeley.edu/pubs/ccog\\_2002\\_0580-Klein-Commentary.pdf](http://cornea.berkeley.edu/pubs/ccog_2002_0580-Klein-Commentary.pdf).
- [14] B. Libet, E. W. Wright Jr., B. Feinstein, and D. K. Pearl (1979), *Subjective referral of the timing for a conscious sensory experience* *Brain*, 102, 193-224.

- [15] S. Comorosan(1975), *On a possible biological spectroscopy*, Bull. of Math. Biol., Vol 37, p. 419.  
S. Comorosan, M.Hristea, P. Murogoki (1980), *On a new symmetry in biological systems*, Bull. of Math. Biol., Vol 42, p. 107.
- [A9] The chapter *Does TGD Predict the Spectrum of Planck Constants?* of [TGDview].  
<http://www.helsinki.fi/~matpitka/tgdview/tgdview.html#Planck>.
- [C2] The chapter *Construction of Quantum Theory: S-matrix* of [TGDquant].  
<http://www.helsinki.fi/~matpitka/tgdquant/tgdquant.html#towards>.
- [C4] The chapter *Is it Possible to Understand Coupling Constant Evolution at Space-Time Level?* of [TGDquant].  
<http://www.helsinki.fi/~matpitka/tgdquant/tgdquant.html#rgflow>.
- [D6] The chapter *TGD and Astrophysics* of [TGDclass].  
<http://www.helsinki.fi/~matpitka/tgdclass/tgdclass.html#astro>.
- [E5] The chapter *p-Adic Physics: Physical Ideas* of [TGDnumber].  
<http://www.helsinki.fi/~matpitka/tgdnumber/tgdnumber.html#phblocks>.
- [E9] The chapter *Topological Quantum Computation in TGD Universe* of [TGDnumber].  
<http://www.helsinki.fi/~matpitka/tgdnumber/tgdnumber.html#tqc>.
- [F8] The chapter *TGD and Nuclear Physics* of [TGDpad].  
<http://www.helsinki.fi/~matpitka/paddark/paddark.html#padnucl>.
- [F9] The chapter *Dark Nuclear Physics and Living Matter* of [TGDpad].  
<http://www.helsinki.fi/~matpitka/paddark/paddark.html#exonuclear>.
- [H8] The chapter *p-Adic Physics as Physics of Cognition and Intention* of [TGDconsc].  
<http://www.helsinki.fi/~matpitka/tgdconsc/tgdconsc.html#cognic>.
- [J1] The chapter *Bio-Systems as Super-Conductors: part I* of [TGDware].  
<http://www.helsinki.fi/~matpitka/bioware/bioware.html#superc1>.
- [J2] The chapter *Bio-Systems as Super-Conductors: part II* of [TGDware].  
<http://www.helsinki.fi/~matpitka/bioware/bioware.html#superc2>.
- [J3] The chapter *Bio-Systems as Super-Conductors: part III* of [TGDware].  
<http://www.helsinki.fi/~matpitka/bioware/bioware.html#superc3>.

- [J5] The chapter *Wormhole Magnetic Fields* of [TGDware].  
<http://www.helsinki.fi/~matpitka/bioware/bioware.html#wormc>.
- [J6] The chapter *Coherent Dark Matter and Bio-Systems as Macroscopic Quantum Systems* of [TGDware].  
<http://www.helsinki.fi/~matpitka/bioware/bioware.html#darkbio>.
- [K1] The chapter *Time, Spacetime and Consciousness* of [TGDholo].  
<http://www.helsinki.fi/~matpitka/hologram/hologram.html#time>.
- [L2] The chapter *Many-Sheeted DNA* of [TGDgame].  
<http://www.helsinki.fi/~matpitka/genememe/genememe.html#genecodec>.
- [L4] The chapter *Pre-Biotic Evolution in Many-Sheeted Space-Time* of [TGDgame].  
<http://www.helsinki.fi/~matpitka/genememe/genememe.html#prebio>.
- [M3] The chapter *Dark Matter Hierarchy and Hierarchy of EEGs* of [TGDeeg].  
<http://www.helsinki.fi/~matpitka/tgdeeg/tgdeeg/tgdeeg.html#eegdark>.
- [M4] The chapter *Quantum Model for EEG: Part I* of [TGDeeg].  
<http://www.helsinki.fi/~matpitka/tgdeeg/tgdeeg/tgdeeg.html#eegI>.

## Appendix: Tables comparing predicted and observed radii of exoplanets

The tables below represent the comparison of predictions of TGD based model for the orbital radii with known radii in the case of exoplanets (the model is discussed in section "Orbital radii of exoplanets). In the tables  $R$  denotes the value of minor semiaxis of the planetary orbit using AU as a unit and  $M$  the mass of star using solar mass  $M_S$  as a unit.  $n$  is the value of the principal quantum number and  $R_1$  the radius assuming  $X = (r/s)^2 = 1$  and  $R_2$  the value for the best choice of  $X$  as ratio of "ruler and compass integers". The data about radii of planets are from tables at <http://exoplanets.org/almanacframe.html> and star masses from the references contained by the tables.



Star Name	R	M	n	R1	R1/R	r	s	R2/R
HD73256	0.037	1.05	1	0.042	1.14	16	15	1.00
HD83443	0.040	0.79	1	0.032	0.79	15	17	1.01
HD46375	0.040	1.00	1	0.040	1.00	1	1	1.00
HD179949	0.040	1.24	1	0.050	1.24	17	15	0.97
HD187123b	0.040	1.06	1	0.042	1.06	1	1	1.06
HD120136	0.050	1.30	1	0.052	1.04	1	1	1.04
HD330075	0.046	0.70	1	0.028	0.61	4	5	0.95
BD-103166	0.050	1.10	1	0.044	0.88	15	16	1
HD209458	0.050	1.05	1	0.042	0.84	16	17	0.95
HD76700	0.050	1.00	1	0.040	0.8	15	17	1.03
HD217014	0.050	1.06	1	0.042	0.85	15	16	0.96
HD9826b	0.059	1.30	1	0.052	0.88	15	16	1.00
HD49674	0.060	1.00	1	0.040	0.67	5	6	0.96
HD68988	0.070	1.20	1	0.048	0.69	5	6	0.99
HD168746	0.065	0.88	1	0.035	0.54	3	4	0.96
HD217107	0.070	0.98	1	0.039	0.56	3	4	1
HD162020	0.074	0.75	1	0.030	0.41	2	3	0.91
HD130322	0.088	0.79	1	0.032	0.36	3	5	1
HD108147	0.102	1.27	1	0.051	0.50	3	4	0.89
HD38529b	0.129	1.39	1	0.056	0.43	2	3	0.97
HD75732b	0.115	0.95	1	0.038	0.33	3	5	0.92
HD195019	0.140	1.02	2	0.163	1.17	16	15	1.02
HD6434	0.150	0.79	2	0.126	0.84	15	16	0.96
HD192263	0.150	0.79	2	0.126	0.84	15	16	0.96
GJ876c	0.130	0.32	3	0.115	0.89	15	16	1.01
HD37124b	0.181	0.91	2	0.146	0.80	15	17	1.03
HD143761	0.220	0.95	2	0.152	0.69	5	6	0.99
HD75732c	0.240	0.95	2	0.152	0.63	4	5	0.99
HD74156b	0.280	1.27	2	0.203	0.73	5	6	1.05
HD168443b	0.295	1.01	2	0.162	0.55	3	4	0.97
GJ876b	0.210	0.32	4	0.205	0.98	1	1	0.98
HD3651	0.284	0.79	3	0.284	1.00	1	1	1
HD121504	0.320	1.18	2	0.189	0.59	3	4	1.05
HD178911	0.326	0.87	3	0.313	0.96	1	1	0.96
HD16141	0.350	1.00	3	0.360	1.03	1	1	1.03
HD114762	0.350	0.82	3	0.295	0.84	15	16	0.96
HD80606	0.469	1.10	3	0.396	0.84	15	16	0.96
HD117176	0.480	1.10	3	0.396	0.83	15	16	0.94
HD216770	0.460	0.90	3	0.324	0.70	5	6	1.01

Star Name	R	M	n	R1	R1/R	r	s	R2/R
HD52265	0.49	1.13	3	0.41	0.83	15	16	0.94
HD73526	0.65	1.02	4	0.65	1	1	1	1.00
HD82943c	0.73	1.05	4	0.67	0.92	16	17	1.04
HD8574	0.77	1.17	4	0.75	0.97	1	1	0.97
HD169830	0.82	1.40	4	0.90	1.09	17	16	0.97
HD9826c	0.83	1.30	4	0.83	1.00	1	1	1.00
HD202206	0.83	1.15	4	0.74	0.89	15	16	1.01
HD89744	0.89	1.40	4	0.9	1.01	1	1	1.01
HD134987	0.81	1.05	4	0.67	0.83	15	16	0.94
HD12661b	0.82	1.07	4	0.68	0.84	15	16	0.95
HD150706	0.82	0.98	5	0.98	1.20	16	15	1.05
HD40979	0.81	1.08	4	0.69	0.85	15	16	0.97
HD92788	0.95	1.06	5	1.06	1.12	16	15	0.98
HD142	0.97	1.10	5	1.1	1.13	16	15	1.00
HD28185	1.03	0.99	5	0.99	0.96	1	1	0.96
HD142415	1.07	1.03	5	1.03	0.96	1	1	0.96
HD108874b	1.06	1.00	5	1.00	0.94	1	1	0.94
HD4203	1.09	1.06	5	1.06	0.97	1	1	0.97
HD177830	1.14	1.17	5	1.17	1.03	1	1	1.03
HD128311b	1.02	0.80	6	1.15	1.13	1	1	1.13
HD27442	1.18	1.20	5	1.20	1.02	1	1	1.02
HD210277	1.12	0.99	5	0.99	0.88	15	16	1.01
HD82943b	1.16	1.05	5	1.05	0.91	15	16	1.03
HD20367	1.25	1.17	5	1.17	0.94	1	1	0.94
HD114783	1.19	0.92	6	1.32	1.11	1	1	1.11
HD137759	1.28	1.05	5	1.05	0.82	15	17	1.05
HD19994	1.42	1.34	5	1.34	0.94	1	1	0.94
HD147513	1.26	1.11	5	1.11	0.88	15	16	1.00
HD222582	1.35	1.00	6	1.44	1.07	1	1	1.07
HD65216	1.31	0.92	6	1.32	1.01	1	1	1.01
HD141937	1.52	1.10	6	1.58	1.04	1	1	1.04
HD41004A	1.31	0.70	7	1.37	1.05	1	1	1.05
HD160691b	1.87	1.08	7	2.12	1.13	16	15	0.99

Star Name	R	M	n	R1	R1/R	r	s	R2/R
HD52265	0.49	1.13	3	0.41	0.83	15	16	0.94
HD73526	0.65	1.02	4	0.65	1	1	1	1.00

HD82943c	0.73	1.05	4	0.67	0.92	16	17	1.04
HD8574	0.77	1.17	4	0.75	0.97	1	1	0.97
HD169830	0.82	1.40	4	0.90	1.09	17	16	0.97
HD9826c	0.83	1.30	4	0.83	1.00	1	1	1.00
HD202206	0.83	1.15	4	0.74	0.89	15	16	1.01
HD89744	0.89	1.40	4	0.9	1.01	1	1	1.01
HD134987	0.81	1.05	4	0.67	0.83	15	16	0.94
HD12661b	0.82	1.07	4	0.68	0.84	15	16	0.95
HD150706	0.82	0.98	5	0.98	1.20	16	15	1.05
HD40979	0.81	1.08	4	0.69	0.85	15	16	0.97
HD92788	0.95	1.06	5	1.06	1.12	16	15	0.98
HD142	0.97	1.10	5	1.1	1.13	16	15	1.00
HD28185	1.03	0.99	5	0.99	0.96	1	1	0.96
HD142415	1.07	1.03	5	1.03	0.96	1	1	0.96
HD108874b	1.06	1.00	5	1.00	0.94	1	1	0.94
HD4203	1.09	1.06	5	1.06	0.97	1	1	0.97
HD177830	1.14	1.17	5	1.17	1.03	1	1	1.03
HD128311b	1.02	0.80	6	1.15	1.13	1	1	1.13
HD27442	1.18	1.20	5	1.20	1.02	1	1	1.02
HD210277	1.12	0.99	5	0.99	0.88	15	16	1.01
HD82943b	1.16	1.05	5	1.05	0.91	15	16	1.03
HD20367	1.25	1.17	5	1.17	0.94	1	1	0.94
HD114783	1.19	0.92	6	1.32	1.11	1	1	1.11
HD137759	1.28	1.05	5	1.05	0.82	15	17	1.05
HD19994	1.42	1.34	5	1.34	0.94	1	1	0.94
HD147513	1.26	1.11	5	1.11	0.88	15	16	1.00
HD222582	1.35	1.00	6	1.44	1.07	1	1	1.07
HD65216	1.31	0.92	6	1.32	1.01	1	1	1.01
HD141937	1.52	1.10	6	1.58	1.04	1	1	1.04
HD41004A	1.31	0.70	7	1.37	1.05	1	1	1.05
HD160691b	1.87	1.08	7	2.12	1.13	16	15	0.99

Star Name	R	M	n	R1	R1/R	r	s	R2/R
HD23079	1.65	1.10	6	1.58	0.96	1	1	0.96
HD186427	1.67	1.01	6	1.45	0.87	15	16	0.99
HD4208	1.67	0.93	7	1.82	1.09	16	15	0.96
HD114386	1.62	0.68	8	1.74	1.07	17	16	0.95
HD213240	2.03	1.22	6	1.76	0.87	15	16	0.98
HD10647	2.10	1.07	7	2.10	1.00	1	1	1
HD10697	2.13	1.10	7	2.16	1.01	1	1	1.01
HD95128b	2.09	1.03	7	2.02	0.97	1	1	0.97
HD190228	2.00	0.83	8	2.12	1.06	1	1	1.06
HD114729	2.08	0.93	7	1.82	0.88	15	16	1
HD111232	1.97	0.78	8	2.00	1.01	1	1	1.01
HD2039	2.19	0.98	7	1.92	0.88	15	16	1
HD136118	2.40	1.24	7	2.43	1.01	1	1	1.01
HD50554	2.32	1.07	7	2.09	0.9	15	16	1.02
HD9826d	2.53	1.30	7	2.55	1.01	1	1	1.01
HD196050	2.43	1.10	7	2.16	0.89	15	16	1.01
HD216437	2.43	1.07	8	2.74	1.13	17	15	0.88
HD216435	2.70	1.25	7	2.45	0.91	1	1	0.91
HD169830c	2.75	1.40	7	2.74	1	1	1	1
HD106252	2.54	0.96	8	2.46	0.97	1	1	0.97
HD12661c	2.60	1.07	8	2.74	1.05	1	1	1.05
HD23596	2.86	1.30	7	2.55	0.89	15	16	1.01
HD168443c	2.87	1.01	8	2.59	0.9	15	16	1.03
HD145675	2.85	1.00	8	2.56	0.9	15	16	1.02
HD11964b	3.10	1.10	8	2.82	0.91	16	17	1.03
HD39091	3.29	1.10	9	3.56	1.08	17	16	0.96
HD38529c	3.71	1.39	8	3.56	0.96	1	1	0.96
HD70642	3.30	1.00	9	3.24	0.98	1	1	0.98
HD33636	3.56	0.99	9	3.21	0.9	15	16	1.03
HD95128c	3.73	1.03	10	4.12	1.1	16	15	0.97
HD190360	3.65	0.96	10	3.84	1.05	1	1	1.05
HD74156c	3.82	1.27	9	4.11	1.08	1	1	1.08
HD22049	3.54	0.80	11	3.87	1.09	16	15	0.96
HD30177	3.86	0.95	10	3.80	0.98	1	1	0.98
HD89307	4.15	0.95	10	3.80	0.92	1	1	0.92
HD72659	4.50	0.95	11	4.60	1.02	1	1	1.02
HD75732d	5.90	0.95	13	6.42	1.09	16	15	0.96

# Could q-Laguerre equation explain the claimed fractionation of the principal quantum number for hydrogen atom?

Matti Pitkänen

*Puutarhurinkatu 10 10960, Hanko, Finland, E-mail matpitka@rock.helsinki.fi*

September 25, 2006

## Contents

<b>1</b>	<b>Introduction</b>	<b>1</b>
<b>2</b>	<b>q-Laguerre equation for <math>q = \exp(i\pi/m)</math></b>	<b>2</b>
<b>3</b>	<b>Polynomial solutions of q-Laguerre equation</b>	<b>3</b>
<b>4</b>	<b>Non-polynomial solutions of q-Laguerre equation</b>	<b>4</b>
<b>5</b>	<b>Results of numerical calculations</b>	<b>5</b>
<b>6</b>	<b>How to obtain <math>n^{(q)} = 1/2</math> state?</b>	<b>6</b>
<b>7</b>	<b>Some comments</b>	<b>9</b>

## 1 Introduction

In [G2] a semiclassical model based on dark matter and hierarchy of Planck constants is developed for the fractionized principal quantum number  $n$  claimed by Mills [1] to have at least the values  $n = 1/k$ ,  $k = 2, 3, 4, 5, 6, 7, 10$ . This model could explain the claimed fractionization of the principal quantum number  $n$  for hydrogen atom [1] in terms of single electron transitions for all cases except  $n = 1/2$ : the basis reason is that Jones inclusions are characterized by quantum phases  $q = \exp(i\pi/n)$ ,  $n > 2$ . Since quantum deformation of the standard quantum mechanism is involved, this motivates

an attempt to understand the claimed fractionization in terms of q-analog of hydrogen atom.

The Laguerre polynomials appearing in the solution of Schrödinger equation for hydrogen atom possess quantum variant, so called q-Laguerre polynomials [2], and one might hope that they would allow to realize this semiclassical picture at the level of solutions of appropriately modified Schrödinger equation and perhaps also resolve the difficulty associated with  $n = 1/2$ . Unfortunately, the polynomials discussed in [2] correspond to  $0 < q \leq 1$  rather than complex values of  $q = \exp(i\pi/m)$  on circle and the extrapolation of the formulas for energy eigenvalues gives complex energies. It is however easy to modify the definition of q-derivative and it turns out that it is possible to reproduce  $n = 1/2$  state exactly and  $n = 1/m$ ,  $m > 2$  states in a reasonable approximation as solutions of q-Laguerre equation for s-wave states. Also the generalization to associated q-Laguerre equation is straightforward.

## 2 q-Laguerre equation for $q = \exp(i\pi/m)$

The most obvious modification of the Laguerre equation for  $S$ -wave sates (which are the most interesting by semiclassical argument) in the complex case is based on the replacement

$$\begin{aligned} \partial_x &\rightarrow \frac{1}{2}(\partial_x^q + \partial_x^{\bar{q}}) \\ \partial_x^q f &= \frac{f(qx) - f(x)}{q - 1} , \\ q &= \exp(i\pi/m) \end{aligned} \quad (1)$$

to guarantee hermiticity. When applied to the Laguerre equation

$$x \frac{d^2 L_n}{dx^2} + (1 - x) \frac{dL_n}{dx} = nL_n , \quad (2)$$

and expanding  $L_n$  into Taylor series

$$L_n(x) = \sum_{n \geq 0} l_n x^n , \quad (3)$$

one obtains difference equation

$$\begin{aligned}
a_{n+1}l_{n+1} + b_n l_n &= 0 , \\
a_{n+1} &= \frac{1}{4R_1^2} [R_{2n+1} - R_{2n} + 2R_{n+1}R_1 + 3R_1] + \frac{1}{2R_1} [R_{n+1} + R_1] \\
b_n &= \frac{R_n}{2R_1} - n^{q)} + \frac{1}{2} , \\
R_n &= 2\cos [(n-1)\pi/m] - 2\cos [n\pi/m] .
\end{aligned} \tag{4}$$

Here  $n^{q)}$  is the fractionized principal quantum number determining the energy of the q-hydrogen atom. One cannot pose the difference equation on  $l_0$  since this together with the absence of negative powers of  $x$  would imply the vanishing of the entire solution. This is natural since for first order difference equations lowest term in the series should be chosen freely.

### 3 Polynomial solutions of q-Laquerre equation

The condition that the solution reduces to a polynomial reads as

$$b_n = 0 \tag{5}$$

and gives

$$n^{q)} = \frac{1}{2} + \frac{R_n}{2R_1} , \tag{6}$$

For  $n = 1$  one has  $n^{q)} = 1$  so that the ground state energy is not affected. At the limit  $N \rightarrow \infty$  one obtains  $n^{q)} \rightarrow n$  so that spectrum reduces to that for hydrogen atom. The periodicity  $R_{n+2Nk} = R_n$  reflects the corresponding periodicity of the difference equation which suggests that only the values  $n \leq 2m-1$  belong to the spectrum. Spectrum is actually symmetric with respect to the middle point  $[N/2]$  which suggests that only  $n < [m/2]$  corresponds to the physical spectrum. An analogous phenomenon occurs for representations of quantum groups. When  $m$  increases the spectrum approaches integer valued spectrum and one has  $n > 1$  so that no fractionization in the desired sense occurs for polynomial solutions.

## 4 Non-polynomial solutions of q-Laquerre equation

One might hope that non-polynomial solutions associated with some fractional values of  $n^q$  near to those claimed by Mills might be possible. Since the coefficients  $a_n$  and  $b_n$  are periodic, one can express the solution ansatz as

$$\begin{aligned} L_n(x) &= P_a^{2m}(x) \sum_k a^k x^{2mk} = P_a^{2m}(x) \frac{1}{1 - ax^{2m}} , \\ P_a^{2m}(x) &= \sum_{k=0}^{2m-1} l_k x^k , \\ a &= \frac{l_{2m}}{l_0} , \end{aligned} \quad (7)$$

This solution behaves as  $1/x$  asymptotically but has pole at  $x_\infty = (1/a)^{1/2m}$  for  $a > 0$ .

The expression for  $l_{2m}/l_0 = a$  is

$$a = \prod_{k=1}^{2m} \frac{b_{2m-k}}{a_{2m-k+1}} . \quad (8)$$

This can be written more explicitly as

$$\begin{aligned} a &= (2R_1)^{2m} \prod_{k=1}^{2m} X_k , \\ X_k &= \frac{R_{2m-k} + (-2n^q + 1)R_1}{R_{4m-2k+1} - R_{4m-2k} + 4R_{2m-k+1}R_1 + 2R_1^2 + 3R_1} , \\ R_n &= 2\cos[(n-1)\pi/m] - 2\cos[n\pi/m] . \end{aligned} \quad (9)$$

This formula is a specialization of a more general formula for  $n = 2m$  and resulting ratios  $l_n/l_0$  can be used to construct  $P_a^{2m}$  with normalization  $P_a^{2m}(0) = 1$ .



## 5 Results of numerical calculations

Numerical calculations demonstrate following.

a) For odd values of  $m$  one has  $a < 0$  so that a continuous spectrum of energies seems to result without any further conditions.

b) For even values of  $m$   $a$  has a positive sign so that a pole results.

For even value of  $m$  it could happen that the polynomial  $P_a^{2m}(x)$  has a compensating zero at  $x_\infty$  so that the solution would become square integrable. The condition for reads explicitly

$$P_a^{2m} \left( \left( \frac{1}{a} \right)^{\frac{1}{2m}} \right) = 0 . \quad (10)$$

If  $P_a^{2m}(x)$  has zeros there are hopes of finding energy eigen values satisfying the required conditions. Laguerre polynomials and also q-Laguerre polynomials must possess maximal number of real zeros by their orthogonality implied by the hermiticity of the difference equation defining them. This suggests that also  $P_a^{2m}(x)$  possesses them if  $a$  does not deviate too much from zero. Numerical calculations demonstrate that this is the case for  $n^q < 1$ .

For ordinary Laguerre polynomials the naive estimate for the position of the most distant zero in the units used is larger than  $n$  but not too much so. The naive expectation is that  $L_{2m}$  has largest zero somewhat above  $x = 2m$  and that same holds true a small deformation of  $L_{2m}$  considered now since the value of the parameter  $a$  is indeed very small for  $n^q < 1$ . The ratio  $x_\infty/2m$  is below .2 for  $m \leq 10$  so that this argument gives good hopes about zeros of desired kind.

One can check directly whether  $x_\infty$  is near to zero for the experimentally suggested candidates for  $n^q$ . The table below summarizes the results of numerical calculations.

a) The table gives the exact eigenvalues  $1/n_q$  with a 4-decimal accuracy and corresponding approximations  $1/n_q \simeq k$  for  $k = 3, \dots, 10$ . For a given value of  $m$  only single eigenvalue  $n^q < 1$  exists. If the observed anomalous spectral lines correspond to single electron transitions, the values of  $m$  for them must be different. The value of  $m$  for which  $n^q \simeq 1/k$  approximation is optimal is given with boldface. The value of  $k$  increases as  $m$  increases. The lowest value of  $m$  allowing the desired kind of zero of  $P^{2m}$  is  $m = 18$  and for  $k \in \{3, 10\}$  the allowed values are in range 18, ..., 38.

b)  $n^q = 1/2$  does not appear as an approximate eigenvalue so that for even values of  $m$  quantum calculation produces same disappointing result

as the classical argument. Below it will be however found that  $n^q) = 1/2$  is a universal eigenvalue for odd values of  $m$ .

m	$1/n_{\simeq}^q)$	$1/n^q)$	m	$1/n_{\simeq}^q)$	$1/n^q)$
<b>18</b>	<b>3</b>	2.7568	30	8	7.5762
<b>20</b>	<b>4</b>	3.6748	<b>32</b>	<b>8</b>	8.3086
22	5	4.5103	<b>34</b>	<b>9</b>	9.0342
<b>24</b>	<b>5</b>	5.3062	<b>36</b>	<b>10</b>	9.7529
<b>26</b>	<b>6</b>	6.0781	38	10	10.4668
<b>28</b>	<b>7</b>	6.8330			

Table 1. The table gives the approximations  $1/n^q)_{\simeq} = 1/k$  and corresponding exact values  $1/n^q)$  in the range  $k = 3, \dots, 10$  for which  $P_a^{2m})(x_{\infty})$  is nearest to zero. The corresponding values of  $m = 2k$  vary in the range,  $k = 18, \dots, 38$ . For odd values of  $m$  the value of the parameter  $a$  is negative so that there is no pole. Boldface marks for the best approximation by  $1/n_{\simeq}^q) = k$ .

## 6 How to obtain $n^q) = 1/2$ state?

For odd values of  $m$  the quantization recipe fails and physical intuition tells that there must be some manner to carry out quantization also now. The following observations give a hunch about be the desired condition.

a) For the representations of quantum groups only the first  $m$  spins are realized. This suggests that there should exist a symmetry relating the coefficients  $l_n$  and  $l_{n+m}$  and implying  $n^q) = 1/2$  for odd values of  $m$ . This symmetry would remove also the double degeneracy associated with the almost integer eigenvalues of  $n^q)$ . Also other fractional states are expected on basis of physical intuition.

b) For  $n^q) = 1/2$  the recursion formula for the coefficients  $l_n$  involves only the coefficients  $R_m$ .

c) The coefficients  $R_k$  have symmetries  $R_k = R_{k+2m}$  and  $R_{k+m} = -R_m$ . There is indeed this kind of symmetry. From the formula

$$\frac{l_n}{l_0} = (2R_1)^n \prod_{k=1}^n X_k ,$$

$$X_k = \frac{R_{n-k} + (-2n^q) + 1)R_1}{[R_{2n-2k+1} - R_{n-2k} + 4R_{n-k+1}R_1 + 2R_1^2 + 3R_1]} \quad (11)$$

one finds that for  $n^q) = 1/2$  the formula giving  $l_{n+m}$  in terms of  $l_n$  changes sign when  $n$  increases by one unit

$$\begin{aligned} A_{n+1} &= (-1)^m A_n , \\ A_n &= \prod_{k=1}^m \frac{b_{n+m-k}}{a_{n+m-k+1}} = \prod_{k=1}^m (2R_1)^m \prod_{k=1}^m X_{k+n} . \end{aligned} \quad (12)$$

The change of sign is essentially due to the symmetries  $a_{n+m} = -a_n$  and  $b_{n+m} = b_n$ . This means that the action of translations on  $A_n$  in the space of indices  $n$  are represented by group  $Z_2$ .

This symmetry implies  $a = l_{2m}/l_0 = -(l_m)(l_0)^2$  so that for  $n^q) = 1/2$  the polynomial in question has a special form

$$\begin{aligned} P_a^{2m)} &= P_a^m)(1 - Ax^m) , \\ A &= A_0 . \end{aligned} \quad (13)$$

The relationship  $a = -A^2$  implies that the solution reduces to a form containing the product of  $m^{th}$  (rather than  $(2m)^{th}$ ) order polynomial with a geometric series in  $x^m$  (rather than  $x^{2m}$ ):

$$L_{1/2}(x) = \frac{P_a^m)(x)}{1 + Ax^m} . \quad (14)$$

Hence the  $n$  first terms indeed determine the solution completely. For even values of  $m$  one obtains similar result for  $n^q) = 1/2$  but now  $A$  is negative so that the solution is excluded. This result also motivates the hypothesis that for the counterparts of ordinary solutions of Laguerre equation sum (even  $m$ ) or difference (odd  $m$ ) of solutions corresponding to  $n$  and  $2m - n$  must be formed to remove the non-physical degeneracy.

This argument does not exclude the possibility that there are also other fractional values of  $n$  allowing this kind of symmetry. The condition for symmetry would read as

$$\begin{aligned} \prod_{k=1}^m (R_k + \epsilon R_1) &= \prod_{k=1}^m (R_k - \epsilon R_1) , \\ \epsilon &= (2n^q) - 1 . \end{aligned} \quad (15)$$

The condition states that the odd part of the polynomial in question vanishes. Both  $\epsilon$  and  $-\epsilon$  solutions so that  $n^{q)}$  and  $1 - n^{q)}$  are solutions. If one requires that the condition holds true for all values of  $m$  then the comparison of constant terms in these polynomials allows to conclude that  $\epsilon = 0$  is the only universal solution. Since  $\epsilon$  is free parameter, it is clear that the  $m$ :th order polynomial in question has at most  $m$  solutions which could correspond to other fractionized eigenvalues expected to be present on basis of physical intuition.

This picture generalizes also to the case of even  $n$  so that also now solutions of the form of Eq. 14 are possible. In this case the condition is

$$\prod_{k=1}^m (R_k + \epsilon R_1) = - \prod_{k=1}^m (R_k - \epsilon R_1) . \quad (16)$$

Obviously  $\epsilon = 0$  and thus  $n = 1/2$  fails to be a solution to the eigenvalue equation in this case. Also now one has the spectral symmetry  $n_{\pm} = 1/2 \pm \epsilon$ .

The symmetry  $R_n = (-1)^m R_{n+m-1} = (-1)^m R_{n-m-1} = (-1)^m R_{m-n+1}$  can be applied to show that the polynomials associated with  $\epsilon$  and  $-\epsilon$  contain both the terms  $R_n - \epsilon$  and  $R_n + \epsilon$  as factors except for odd  $m$  for  $n = (m + 1)/2$ . Hence the values of  $n$  can be written for even values of  $m$  as

$$n^{q)}(n) = \frac{1}{2} \pm \frac{R_n}{2R_1} , \quad n = 1, \dots, \frac{m}{2} , \quad (17)$$

and for odd values of  $m$  as

$$\begin{aligned} n_{\pm}^{q)}(n) &= \frac{1}{2} \pm \frac{R_n}{2R_1} , \quad n = 1, \dots, \frac{m+1}{2} - 1 , \\ n^{q)} &= 1/2 . \end{aligned} \quad (18)$$

Plus sign obviously corresponds to the solutions which reduce to polynomials and to  $n^{q)} \simeq n$  for large  $m$ . The explicit expression for  $n^{q)}$  reads as

$$n_{\pm}^{q)}(n) = \frac{1}{2} \pm \frac{(\sin^2(\pi(n-1)/2m) - \sin^2(\pi n/2m))}{2\sin^2(\pi/2m)} . \quad (19)$$

At the limit of large  $m$  one has

$$n_{+}^{q)}(n) \simeq n , \quad n_{-}^{q)}(n) \simeq 1 - n . \quad (20)$$

so that the fractionization  $n \simeq 1/k$  claimed by Mills is not obtained at this limit. The minimum for  $|n^q|$  satisfies  $|n^q| < 1$  and its smallest value  $|n^q| = .7071$  corresponds to  $m = 4$ . Thus these zeros cannot correspond to  $n^q \simeq 1/k$  yielded by the numerical computation for even values of  $m$  based on the requirement that the zero of  $P^{2m}$  cancels the pole of the geometric series.

## 7 Some comments

Some closing comments are in order.

a) An open question is whether there are also zeros  $|n^q| > 1$  satisfying  $P_a^{2m}((1/a)^{1/2m}) = 0$  for even values of  $m$ .

b) The treatment above is not completely general since only s-waves are discussed. The generalization is however a rather trivial replacement  $(1-x)d/dx \rightarrow (l+1-x)d/dx$  in the Laguerre equation to get associated Laguerre equation. This modifies only the formula for  $a_{n+1}$  in the recursion for  $l_n$  so that expression for  $n^q$ , which depends on  $b_n$ 's only, is not affected. Also the product of numerators in the formula for the parameter  $a = l_{2m}/l_0$  remains invariant so that the general spectrum has the spectral symmetry  $n^q \rightarrow 1 - n^q$ . The only change to the spectrum occurs for even values of  $m$  and is due to the dependence of  $x_\infty = (1/a)^{1/2m}$  on  $l$  and can be understood in the semiclassical picture. It might happen that the value of  $l$  is modified to its  $q$  counterpart corresponding to q-Legendre functions.

c) The model could explain the findings of Mills and  $n^q \simeq 1/k$  for  $k > 2$  also fixes the value of corresponding  $m$  to a very high degree so that one would have direct experimental contact with generalized imbedding space, spectrum of Planck constants, and dark matter.

d) The obvious question is whether q-counterparts of angular momentum eigenstates ( $idf_m/d\phi = mf_m$ ) are needed and whether they make sense. The basic idea of construction is that the phase transition changing  $\hbar$  does not involve any other modifications except fractionization of angular momentum eigenvalues and momentum eigenvalues having purely geometric origin. One can however ask whether it is possible to identify q-plane waves as ordinary plane waves. Using the definition  $L_z = 1/2(\partial_u^q + \partial_{\bar{u}}^q)$ ,  $u = \exp(i\phi)$ , one obtains  $f_n = \exp(in\phi)$  and eigenvalues as  $n^q = R_n/R_1 \rightarrow n$  for  $m \rightarrow \infty$ . Similar construction applies in the case of momentum components.

d) The obvious question is whether q-counterparts of angular momentum eigenstates ( $idf_m/d\phi = mf_m$ ) are needed and whether they make sense. The basic idea of construction is that the phase transition changing  $\hbar$  does not

involve any other modifications except fractionization of angular momentum eigenvalues and momentum eigenvalues having purely geometric origin. One can however ask whether it is possible to identify q-plane waves as ordinary plane waves. Using the definition  $L_z = 1/2(\partial_u^q + \partial_{\bar{u}}^q)$ ,  $u = \exp(i\phi)$ , one obtains  $f_n = \exp(in\phi)$  and eigenvalues as  $n^q = R_n/R_1 \rightarrow n$  for  $m \rightarrow \infty$ . Similar construction applies in the case of momentum components.

## References

- [tgdfree] M. Pitkänen (2006), *TGD and Fringe Physics*.  
<http://www.helsinki.fi/~matpitka/freenergy/freenergy.html>.
- [G2] The chapter *The Notion of Free Energy and Many-Sheeted Space-Time Concept* of [tgdfree].  
<http://www.helsinki.fi/~matpitka/freenergy/freenergy.html#freenergy>.
- [1] R. Mills *et al*(2003), *Spectroscopic and NMR identification of novel hybrid ions in fractional quantum energy states formed by an exothermic reaction of atomic hydrogen with certain catalysts*.  
<http://www.blacklightpower.com/techpapers.html> .
- [2] D. S. Moak (1981), *The q-analogue of the Laguerre polynomials*, J. Math. Anal. Appl. 81 20 - 47.

# On quantization in astrophysics

Fu Yuhua

China Offshore Oil Research Center, Beijing, 100027, China

E-mail: [fuyh@cnooc.com.cn](mailto:fuyh@cnooc.com.cn)

## 1. Some Problems Cannot Be Solved By Relativity

### 1.1. Special Twin Paradox That Two Brothers' States of Motion Are Quite Same

According to theory of relativity: Supposing they are pair of twins, the younger brother keeps on the Earth, the elder brother roams through the outer space as a astronaut. As the elder brother returns to the Earth, he will be much younger than his younger brother. The twin paradox means: Because the movement is relative, also may think the younger brother is carrying on the space navigation, therefore the younger brother should be much younger than the elder brother. Such two conclusions mutually conflict.

The explanation to this twin paradox given by the theory of relativity is as follows: Two brothers' states of motion are different. Thereupon we may make another special twin paradox that two brothers' states of motion are quite same. If the younger brother doesn't keep on the Earth, but the elder brother and the younger brother all ride their respective high speed airships, facing the completely opposite directions to navigate from the identical time and the identical site with the same speed along a straight line, after a quite long period they begin to decelerate simultaneously until static, then they turn around to navigate again along the same straight line with the manner of front to front, finally simultaneously return to the starting point. From the younger brother's viewpoint that, according to the theory of relativity, the elder brother should be much younger than the younger brother; Similarly, from the elder brother's viewpoint that, according to the theory of relativity, the younger brother should be much younger than the elder brother. Who is much younger to the end?

With the theory of relativity, how to explain this special twin paradox that two brothers' states of motion are quite same?

## 2. Quantization in Astrophysics Realized by Fractal Method

As everybody knows, the energy formula proposed by Planck is as follows

$$E_n = nh\nu$$

where:  $n=0, 1, 2, \dots$

The quantization concept was introduced from this example.

Similarly, the quantization in astrophysics realized by fractal method, will be allowed to reach this goal through taking some variables in the fractal formula for the integer.

Recently, fractal method has been successful used in many fields, it is used for opening out the deeply hidden organized structure in the complicated phenomenon. The quantity for reflecting the character of organized structure is called the fractal dimension, expressed with the value of  $D$ .

The fractal distribution may be defined as follows <sup>[1]</sup>

$$N = \frac{C}{r^D} \quad (1)$$

where:  $r$  is the characteristic scale, such as velocity, mass, time, length and so on, in astrophysics  $r$  may be taken for the planetary orbital motion average velocity, mass, equatorial radius, volume, average density, orbital semi-major axis and so on;  $N$  is the quantity related with the value of  $r$ , such as price, temperature, height and so on, in order to realize the quantization in astrophysics,  $N$  may be taken for the planetary arrange sequence number and so on, namely  $N=1, 2, 3, \dots$ ;  $C$  is a constant to be determined,  $D$  is the fractal dimension.

It should be noted that in order to realize the quantization in astrophysics,  $r$  also may be taken for the integer, namely  $r=1, 2, 3, \dots$ . But we will not consider this case here.

In the fractal methods for general application at present, the fractal dimension  $D$  is a constant, this kind of fractal may be called constant dimension fractal. It is a straight line on the double logarithmic coordinates. for example the values of fractal dimension  $D$  for different coastlines may be taken as 1.02, 1.25 and so on. But for the non-straight line functional relation in the double logarithmic coordinates, it is unable to process with the constant dimension fractal. While many questions are belonging to this kind of situation. In order to overcome this difficulty, we introduced the concept of variable dimension fractal in references [2] ~ [4], namely the fractal dimension  $D$  is the function of characteristic scale  $r$ .

$$D = F(r)$$

Furthermore, we also introduced the concept of complex number dimension fractal (the fractal dimension  $D$  was taken for complex number) in reference [5]; in reference [6, 7], we introduced the concept of fractal series, in which the exponents of Taylor series and the like were changed from integer to fraction.

Now we analyze the fractal quantization structure of the nine planets in solar system, and forecast the related parameter of the tenth planet. This example is taken from reference [8].

The fractal quantization structure of the nine planets in solar system, may be fitted with two fractal straight lines on the double logarithmic coordinates.

Above all we discuss the orbital motion average velocities of the nine planets (unit: km/s), taking the characteristic dimension  $r$  for some planet orbital motion average velocity, taking the value of  $N$  for the serial number according to the size of the orbital motion average velocity, firstly considering the case of Mercury  $r=47.89$ , then we have  $N=1$  (Mercury's orbital motion average velocity is the greatest), thereupon we have the coordinates point (47.89, 1), according to analogizes other 8 planets coordinates points are as follows: (35.03, 2), (29.79, 3), (24.13, 4), (13.06, 5), (9.64, 6), (6.81, 7), (5.43, 8), (4.74, 9). The above 9 coordinates points may be plotted on the double logarithmic coordinates ( $r, N$ ), they are fitted well with two straight lines, carrying on the fitting of these two straight lines with least squares method, we have the following results: the



fractal parameters of the straight line corresponding to the coordinates points with N=1, 2, 3 are as follows: C=7609, D=2.31; the fractal parameters of the straight line corresponding to the coordinates points with N=4, 5, 6, 7, 8, 9 are as follows: C=17.56186, D=0.4647264. Therefore, when the tenth planet is located outside Pluto, its orbital motion average velocity will be smaller than 4.74, namely its value of N should be equal to 10, from Eq. (1) we have

$$r = \left(\frac{C}{N}\right)^{1/D} \quad (2)$$

Substituting N=10, C=17.56186 and D=0.4647264 into Eq. (2), it gives the value of r, namely when the tenth planet is located outside Pluto, its orbital motion average velocity is equal to 3.3594 km/s.

Some scientists believed that, the tenth planet also possibly is located inside Uranus, here the known nine planets coordinates points should be as follows: (47.89, 1), (35.03, 2), (29.79, 3), (24.13, 4), (13.06, 5), (9.64, 6), (6.81, 8), (5.43, 9), (4.74, 10), this time the value of N corresponding to the tenth planet should be equal to 7, namely N=7, by using the interpolation method to obtain its orbital motion average velocity is equal to 8.76 km/s.

With the similar method we also have: When the tenth planet is located outside Pluto, to compare with Earth (taking the value of Earth as 1), its mass, equatorial radius, volume, average density, orbital semi-major axis respectively are as follows: 0.00032, 0.145, 0.0028, 0.10, 64.36. If the tenth planet is located inside Uranus, its orbital semi-major axis should be equal to 15.94 to compare with Earth.

#### References

- [1] Turcotte D L. *Fractals and chaos in geology and geophysics*. Cambridge: Cambridge University Press, 1992. 1~22
- [2] Fu Yuhua. Variable dimension fractal in fluid mechanics. *Proc. 2<sup>nd</sup> national numeration hydraulics conference*. 1993:202~207 (in Chinese)
- [3] Fu Yuhua. Improvement of fractal technique on the application in oil and gas prospecting: variable dimension fractal technique. *China Offshore Oil and Gas (Geology)*. 1994, ( 3): 210~214 (in Chinese)
- [4] Fu Yuhua. Analyzed and fractal single point method for solving hydraulic problems in ocean engineering (i.e., SPE(Society of Petroleum Engineers) 29986). *International meeting on petroleum engineering*, Beijing, Nov 1995. 347~356
- [5] Fu Yuhua. Fractal in Complex Domain and Its Application in Ocean Hydrology. *China Offshore Oil and Gas (Engineering)*. 2003, (1): 32~33 (in Chinese)
- [6] Fu Yuhua. Fractal Series Solution for Mechanics Problem. *Journal of Southwest Jiaotong University* ,1999, (5) (in Chinese)
- [7] Fu Yuhua. **Application of Fractal Series Perturbation Method in Vibration Problem**. *Structure & Environment Engineering* , 2001, (1) : 62~64 (in Chinese)
- [8] Fu Yuhua. Science Unsettled Question — Tenth Planet. *Scientific Chinese*, 1999, (3) (in Chinese)

# Weyl geometry, Extended Relativity, Supersymmetry, and Application in Astrophysics

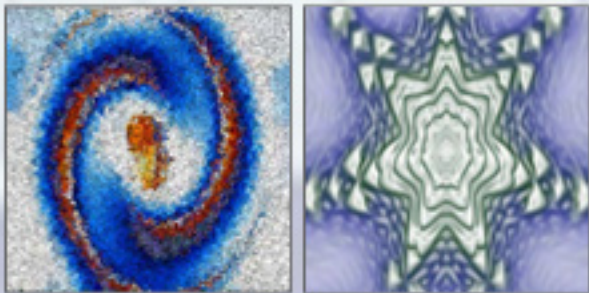

# On Nonlinear Quantum Mechanics, Brownian Motion, Weyl Geometry and Fisher Information

Carlos Castro<sup>1</sup>, Jorge Mahecha<sup>2</sup>

<sup>1</sup>*Center for Theoretical Studies of Physical Systems,*

*Clark Atlanta University, Atlanta, Georgia, USA, castro@ctsps.cau.edu*

<sup>2</sup>*Institute of Physics, University of Antioquia, Medellín, Colombia, mahecha@fisica.udea.edu.co*

February 2005

## Abstract

A new nonlinear Schrödinger equation is obtained explicitly from the (fractal) Brownian motion of a massive particle with a complex-valued diffusion constant. Real-valued energy plane-wave solutions and solitons exist in the free particle case. One remarkable feature of this nonlinear Schrödinger equation based on a (fractal) Brownian motion model, over all the other nonlinear QM models, is that the quantum-mechanical energy functional coincides precisely with the field theory one. We finalize by showing why a *complex* momentum is essential to fully understand the physical implications of Weyl's geometry in QM, along with the interplay between Bohm's Quantum potential and Fisher Information which has been overlooked by several authors in the past.

PACS numbers: 03.65, 05.40.J, 47.53, 04.20.G

## 1 Introduction

Over the years there has been a considerable debate as to whether linear QM can fully describe Quantum Chaos. Despite that the quantum counterparts of classical chaotic systems have been studied via the techniques of linear QM, it is our opinion that Quantum Chaos is truly a new paradigm in physics which is associated with non-unitary and nonlinear QM processes based on non-Hermitian operators (implementing time symmetry breaking). This Quantum Chaotic behavior should be linked more directly to the Nonlinear Schrödinger equation without any reference to the nonlinear behavior of the classical limit. For this reason, we will analyze in detail the fractal geometrical features underlying our Nonlinear Schrödinger equation obtained in [6].

Nonlinear QM has a practical importance in different fields, like condensed matter, quantum optics and atomic and molecular physics; even quantum gravity may involve nonlinear QM. Another important example is in the modern field of quantum computing. If quantum states exhibit small nonlinearities during their temporal evolution, then quantum computers can be used to solve NP-complete (non polynomial) and #P problems in polynomial time. Abrams and Lloyd [19] proposed logical gates based on non linear Schrödinger equations and suggested that a further step in quantum computing consists in finding physical systems whose evolution is amenable to be described by a NLSE.

On other hand, we consider that Nottale and Ord's formulation of quantum mechanics [1], [2] from first principles based on the combination of scale relativity and fractal space-time is a very promising field of future research. In this work we extend Nottale and Ord's ideas to derive the nonlinear Schrödinger equation. This could shed some light on the physical systems which could be appropriately described by the nonlinear Schrödinger equation derived in what follows.

The contents of this work are the following : In section 2 we derive the nonlinear Schrödinger equation by extending Nottale-Ord's approach to the case of a fractal Brownian motion with a complex diffusion constant. We present a thorough analysis of such nonlinear Schrödinger equation and show why it cannot linearized by a naive complex scaling of the wavefunction  $\psi \rightarrow \psi^\lambda$ .

Afterwards we will describe the explicit interplay between Fisher Information, Weyl geometry and the Bohm's potential by introducing an action based on a *complex* momentum. The connection between Fisher Information and Bohm's potential has been studied by several authors [24], however the importance of introducing a *complex* momentum  $P_k = p_k + iA_k$  (where  $A_k$  is the Weyl gauge field of dilatations) in order to fully understand the physical implications of Weyl's geometry in QM, along with the interplay between Bohm's quantum potential and Fisher Information, has been overlooked by several authors in the past [24], [25]. For this reason we shall review in section 3 the relationship between Bohm's Quantum Potential and the Weyl curvature scalar of the Statistical ensemble of particle-paths ( an Abelian fluid ) associated to a single particle that was initially developed by [22] . A Weyl geometric formulation of the Dirac equation and the nonlinear Klein-Gordon wave equation was provided by one of us [23]. In the final section 4 , we summarize our conclusions and include some additional comments.

## 2 Nonlinear QM as a fractal Brownian motion with a complex diffusion constant

We will be following very closely Nottale's derivation of the ordinary Schrödinger equation [1]. The readers familiar with this work may omit this section. Recently Nottale and Celerier [1] following similar methods were able to derive the Dirac equation using bi-quaternions and after breaking the parity symmetry

$dx^\mu \leftrightarrow -dx^\mu$ , see references for details. Also see the Ord's paper [2] and the Adlers's book on quaternionic QM [16]. For simplicity the one-particle case is investigated, but the derivation can be extended to many-particle systems. In this approach particles do not follow smooth trajectories but fractal ones, that can be described by a continuous but non-differentiable fractal function  $\vec{r}(t)$ . The time variable is divided into infinitesimal intervals  $dt$  which can be taken as a given scale of the resolution.

Then, following the definitions given by Nelson in his stochastic QM approach (Lemos in [12] p. 615; see also [13, 14]), Nottale define mean backward and forward derivatives as follows,

$$\frac{d_{\pm}\vec{r}(t)}{dt} = \lim_{\Delta t \rightarrow \pm 0} \left\langle \frac{\vec{r}(t + \Delta t) - \vec{r}(t)}{\Delta t} \right\rangle, \quad (1)$$

from which the forward and backward mean velocities are obtained,

$$\frac{d_{\pm}\vec{r}(t)}{dt} = \vec{b}_{\pm}. \quad (2)$$

For his deduction of Schrödinger equation from this fractal space-time classical mechanics, Nottale starts by defining the complex-time derivative operator

$$\frac{\delta}{dt} = \frac{1}{2} \left( \frac{d_+}{dt} + \frac{d_-}{dt} \right) - i \frac{1}{2} \left( \frac{d_+}{dt} - \frac{d_-}{dt} \right), \quad (3)$$

which after some straightforward definitions and transformations takes the following form,

$$\frac{\delta}{dt} = \frac{\partial}{\partial t} + \vec{V} \cdot \vec{\nabla} - iD\nabla^2. \quad (4)$$

$D$  is a real-valued diffusion constant to be related to the Planck constant. Now we are changing the meaning of  $D$ , since no longer a symbol for the fractal dimension is needed, it will have the value 2.

The  $D$  comes from considering that the scale dependent part of the velocity is a Gaussian stochastic variable with zero mean, (see de la Peña at [12] p. 428)

$$\langle d\xi_{\pm i} d\xi_{\pm j} \rangle = \pm 2D\delta_{ij}dt. \quad (5)$$

In other words, the fractal part of the velocity  $\vec{\xi}$ , proportional to the  $\vec{\zeta}$ , amount to a Wiener process when the fractal dimension is 2.

Afterwards, Nottale defines a set of complex quantities which are generalization of well known classical quantities (Lagrange action, velocity, momentum, etc), in order to be coherent with the introduction of the complex-time derivative operator. The complex time dependent wave function  $\psi$  is expressed in terms of a Lagrange action  $S$  by  $\psi = e^{iS/(2mD)}$ .  $S$  is a complex-valued action but  $D$  is real-valued. The velocity is related to the momentum, which can be expressed as the gradient of  $S$ ,  $\vec{p} = \vec{\nabla}S$ . Then the following known relation is found,

$$\vec{V} = -2iD\vec{\nabla} \ln \psi. \quad (6)$$

The Schrödinger equation is obtained from the Newton's equation (force = mass times acceleration) by using the expression of  $\vec{V}$  in terms of the wave function  $\psi$ ,

$$-\vec{\nabla}U = m \frac{\delta}{dt} \vec{V} = -2imD \frac{\delta}{dt} \vec{\nabla} \ln \psi. \quad (7)$$

Replacing the complex-time derivation (4) in the Newton's equation gives us

$$-\vec{\nabla}U = -2im \left( D \frac{\partial}{\partial t} \vec{\nabla} \ln \psi \right) - 2D \vec{\nabla} \left( D \frac{\nabla^2 \psi}{\psi} \right). \quad (8)$$

Simple identities involving the  $\vec{\nabla}$  operator were used by Nottale. Integrating this equation with respect to the position variables finally yields

$$D^2 \nabla^2 \psi + iD \frac{\partial \psi}{\partial t} - \frac{U}{2m} \psi = 0, \quad (9)$$

up to an arbitrary phase factor which may set to zero. Now replacing  $D$  by  $\hbar/(2m)$ , we get the Schrödinger equation,

$$i\hbar \frac{\partial \psi}{\partial t} + \frac{\hbar^2}{2m} \nabla^2 \psi = U \psi. \quad (10)$$

The Hamiltonian operator is Hermitian, this equation is linear and clearly is homogeneous of degree one under the substitution  $\psi \rightarrow \lambda\psi$ .

Having reviewed Nottale's work [1] we can generalize it by relaxing the assumption that the diffusion constant is real; we will be working with a complex-valued diffusion constant; i.e. with a complex-valued  $\hbar$ . This is our new contribution. The reader may be immediately biased against such approach because the Hamiltonian ceases to be Hermitian and the energy becomes complex-valued. However this is not always the case. We will explicitly find plane wave solutions and soliton solutions to the nonlinear and non-Hermitian wave equations with real energies and momenta. For a detailed discussion on complex-valued spectral representations in the formulation of quantum chaos and time-symmetry breaking see [10]. Nottale's derivation of the Schrödinger equation in the previous section required a complex-valued action  $S$  stemming from the complex-valued velocities due to the breakdown of symmetry between the forwards and backwards velocities in the fractal zigzagging. If the action  $S$  was complex then it is not farfetched to have a complex diffusion constant and consequently a complex-valued  $\hbar$  (with same units as the complex-valued action).

Complex energy is not alien in ordinary linear QM. They appear in optical potentials (complex) usually invoked to model the absorption in scattering processes [8] and decay of unstable particles. Complex potentials have also been used to describe decoherenc. The accepted way to describe resonant states in atomic and molecular physics is based on the complex scaling approach, which in a natural way deals with complex energies [17]. Before, Nottale wrote,

$$\langle d\zeta_{\pm} d\zeta_{\pm} \rangle = \pm 2Ddt, \quad (11)$$

with  $D$  and  $2mD = \hbar$  real. Now we set

$$\langle d\zeta_{\pm}d\zeta_{\pm} \rangle = \pm(D + D^*)dt, \quad (12)$$

with  $D$  and  $2mD = \hbar = \alpha + i\beta$  complex. The complex-time derivative operator becomes now

$$\frac{\delta}{dt} = \frac{\partial}{\partial t} + \vec{V} \cdot \vec{\nabla} - \frac{i}{2}(D + D^*)\nabla^2. \quad (13)$$

In the real case  $D = D^*$ . It reduces to the complex-time-derivative operator described previously by Nottale. Writing again the  $\psi$  in terms of the complex action  $S$ ,

$$\psi = e^{iS/(2mD)} = e^{iS/\hbar}, \quad (14)$$

where  $S$ ,  $D$  and  $\hbar$  are complex-valued, the complex velocity is obtained from the complex momentum  $\vec{p} = \vec{\nabla}S$  as

$$\vec{V} = -2iD\vec{\nabla} \ln \psi. \quad (15)$$

The NLSE is obtained after we use the generalized Newton's equation (force = mass times acceleration) in terms of the  $\psi$  variable,

$$-\vec{\nabla}U = m\frac{\delta}{dt}\vec{V} = -2imD\frac{\delta}{dt}\vec{\nabla} \ln \psi. \quad (16)$$

Replacing the complex-time derivation (13) in the generalized Newton's equation gives us

$$\vec{\nabla}U = 2im \left[ D\frac{\partial}{\partial t}\vec{\nabla} \ln \psi - 2iD^2(\vec{\nabla} \ln \psi \cdot \vec{\nabla})(\vec{\nabla} \ln \psi) - \frac{i}{2}(D + D^*)D\nabla^2(\vec{\nabla} \ln \psi) \right]. \quad (17)$$

Now, using the three identities (i):  $\vec{\nabla}\nabla^2 = \nabla^2\vec{\nabla}$ ; (ii):  $2(\vec{\nabla} \ln \psi \cdot \vec{\nabla})(\vec{\nabla} \ln \psi) = \vec{\nabla}(\vec{\nabla} \ln \psi)^2$ ; and (iii):  $\nabla^2 \ln \psi = \nabla^2\psi/\psi - (\vec{\nabla} \ln \psi)^2$  allows us to integrate such equation above yielding, after some straightforward algebra, the NLSE

$$i\hbar\frac{\partial\psi}{\partial t} = -\frac{\hbar^2}{2m}\frac{\alpha}{\hbar}\nabla^2\psi + U\psi - i\frac{\hbar^2}{2m}\frac{\beta}{\hbar}\left(\vec{\nabla} \ln \psi\right)^2\psi. \quad (18)$$

Note the crucial minus sign in front of the kinematic pressure term and that  $\hbar = \alpha + i\beta = 2mD$  is complex. When  $\beta = 0$  we recover the linear Schrödinger equation.

The nonlinear potential is now complex-valued in general. Defining

$$W = W(\psi) = -\frac{\hbar^2}{2m}\frac{\beta}{\hbar}\left(\vec{\nabla} \ln \psi\right)^2, \quad (19)$$

and  $U$  the ordinary potential, then the NLSE can be rewritten as

$$i\hbar\frac{\partial\psi}{\partial t} = \left(-\frac{\hbar^2}{2m}\frac{\alpha}{\hbar}\nabla^2 + U + iW\right)\psi. \quad (20)$$

This is the fundamental nonlinear wave equation of this work. It has the form of the ordinary Schrödinger equation with the complex potential  $U + iW$  and the complex  $\hbar$ . The Hamiltonian is no longer Hermitian and the potential  $V = U + iW(\psi)$  itself depends on  $\psi$ . Nevertheless one could have meaningful physical solutions with real valued energies and momenta, like the plane-wave and soliton solutions studied in the next section. Some important remarks are now in order.

- Notice that the NLSE above *cannot* be obtained by a *naive* scaling of the wavefunction

$$\psi = e^{iS/\hbar_o} \rightarrow \psi' = e^{iS/\hbar} = e^{(iS/\hbar_o)(\hbar_o/\hbar)} = \psi^\lambda = \psi^{\hbar_o/\hbar}. \quad \hbar = \text{real}. \quad (21)$$

related to a scaling of the diffusion constant  $\hbar_o = 2mD_o \rightarrow \hbar = 2mD$ . Upon performing such scaling, the ordinary *linear* Schrödinger equation in the variable  $\psi$  will appear to be *nonlinear* in the new scaled wavefunction  $\psi'$

$$i\hbar \frac{\partial \psi'}{\partial t} = -\frac{\hbar^2}{2m} \frac{\hbar_o}{\hbar} \nabla^2 \psi' + U\psi' - \frac{\hbar^2}{2m} \left(1 - \frac{\hbar_o}{\hbar}\right) \left(\vec{\nabla} \ln \psi'\right)^2 \psi'. \quad (22)$$

but this apparent nonlinearity is only an *artifact* of the change of variables (the scaling of  $\psi$ ).

Notice that the latter (apparent) nonlinear equation, despite having the same form as the NLSE, obtained from a complex-diffusion constant, differs *crucially* in the actual values of the coefficients multiplying each of the terms. The NLSE has the complex coefficients  $\alpha/\hbar$  (in the kinetic terms), and  $-i\beta/\hbar$  (in the nonlinear logarithmic terms) with  $\hbar = \alpha + i\beta = \text{complex}$ . However, the nonlinear equation obtained from a naive scaling involves *real* and *different* numerical coefficients than those present in the NLSE. Therefore, the genuine NLSE *cannot* be obtained by a naive scaling (redefinition) of the  $\psi$  and the diffusion constant.

Notice also that even if one scaled  $\psi$  by a complex exponent  $\psi \rightarrow \psi^\lambda$  with  $\lambda = \hbar_o/\hbar$  and  $\hbar = \text{complex}$ , the actual numerical values in the apparent nonlinear equation, in general, would have still been different than those present in the NLSE. However, there is an actual equivalence, if, and only if, the scaling exponent  $\lambda = \hbar_o/\hbar$  obeyed the condition:

$$\alpha = \hbar_o \Rightarrow 1 - \frac{\hbar_o}{\hbar} = 1 - \frac{\alpha}{\hbar} = 1 - \frac{\hbar - i\beta}{\hbar} = i\frac{\beta}{\hbar} \quad (23)$$

in this very special case, the NLSE would be obtained from a linear Schroedinger equation after scaling the wavefunction  $\psi \rightarrow \psi^\lambda$  with a complex exponent  $\lambda = \hbar_o/\hbar = \alpha/\hbar$ . In this very special and restricted case, the NLSE could be *linearized* by a scaling of the wavefunction with complex exponent.

From this analysis one infers, immediately, that if one defines the norm of the complex  $\hbar$ :  $||\hbar|| = \sqrt{\alpha^2 + \beta^2} = \hbar_o$  to coincide precisely with the observed value  $\hbar_o$  of Planck's constant, then  $\alpha \neq \hbar_o$ ,  $i\beta \neq \hbar - \hbar_o$  and, consequently, the NLSE *cannot* be obtained from the ordinary (linear) Schroedinger equations



after a naive scaling, with a complex exponent,  $\psi \rightarrow \psi^\lambda = \psi^{\hbar_o/\hbar}$ . Therefore, a complex diffusion constant  $2mD = \hbar = \alpha + i\beta$ , with the condition  $2m\|D\| = \|\hbar\| = \sqrt{\alpha^2 + \beta^2} = \hbar_o$  (observed value of Planck's constant) ensures that the NLSE is not a mere artifact of the scaling of the wavefunction  $\psi \rightarrow \psi^\lambda = \psi^{\hbar_o/\hbar}$  in the ordinary linear Schroedinger equation.

It is important to emphasize that the diffusion constant is always chosen to be related to Planck constant as follows:  $2m\|D\| = \|\hbar\| = \hbar_o$  which is just the transition length from a fractal to a scale-independence non-fractal regime discussed by Nottale in numerous occasions. In the relativistic scale it is the Compton wavelength of the particle (say an electron):  $\lambda_c = \hbar_o/(mc)$ . In the nonrelativistic case it is the de Broglie wavelength of the electron.

Therefore, the NLSE based on a fractal Brownian motion with a complex valued diffusion constant  $2mD = \hbar = \alpha + i\beta$  represents truly a new physical phenomenon and a hallmark of nonlinearity in QM. For other generalizations of QM see experimental tests of quaternionic QM (in the book by Adler [16]). Equation (18) is the fundamental NLSE of this work.

- A Fractal Scale Calculus description of our NLSE was developed later on by Cresson [20] who obtained, on a rigorous mathematical footing, the same functional form of our NLSE equation above (although with different complex numerical coefficients) by using Nottale's fractal scale-calculus that obeyed a quantum bialgebra. A review of our NLSE was also given later on by [25]. Our nonlinear wave equation originated from a complex-valued diffusion constant that is related to a complex-valued extension of Planck's constant. Hence, a fractal spacetime is deeply ingrained with *nonlinear* wave equations as we have shown and it was later corroborated by Cresson [20].

- Complex-valued viscosity solutions to the Navier-Stokes equations were also analyzed by Nottale leading to the Fokker-Planck equation. Clifford-valued extensions of QM were studied in [21] C-spaces (Clifford-spaces whose enlarged coordinates are polyvectors, i.e antisymmetric tensors) that involved a Clifford-valued number extension of Planck's constant; i.e. the Planck constant was a hypercomplex number. Modified dispersion relations were derived from the underlying QM in Clifford-spaces that lead to faster than light propagation in ordinary spacetime but without violating causality in the more fundamental Clifford spaces. Therefore, one should not exclude the possibility of having complex-extensions of the Planck constant leading to nonlinear wave equations associated with the Brownian motion of a particle in fractal spacetimes.

- Notice that the NLSE (34) obeys the homogeneity condition  $\psi \rightarrow \lambda\psi$  for any constant  $\lambda$ . All the terms in the NLSE are scaled respectively by a factor  $\lambda$ . Moreover, our two parameters  $\alpha, \beta$  are intrinsically connected to a complex Planck constant  $\hbar = \alpha + i\beta$  such that  $\|\hbar\| = \sqrt{\alpha^2 + \beta^2} = \hbar_o$  (observed Planck's constant) rather than being *ah-hoc* constants to be determined experimentally. Thus, the nonlinear QM equation derived from the fractal Brownian motion with complex-valued diffusion coefficient is intrinsically tied up with a non-Hermitian Hamiltonian and with complex-valued energy spectra [10].

- Despite having a non-Hermitian Hamiltonian we still could have eigen-

functions with real valued energies and momenta. Non-Hermitian Hamiltonians ( pseudo-Hermitian) have captured a lot of interest lately in the so-called *PT* symmetric *complex* extensions of QM and QFT [27]. Therefore these ideas cannot be ruled out and they are the subject of active investigation nowadays.

### 3 Complex Momenta, Weyl Geometry, Bohm's Potential and Fisher Information

Despite that the interplay between Fisher Information and Bohm's potential has been studied by several authors [24] the importance of introducing a *complex* momentum  $P_k = p_k + iA_k$  in order to fully understand the physical implications of Weyl's geometry in QM has been overlooked by several authors [24], [25]. We shall begin by reviewing the relationship between the Bohm's Quantum Potential and the Weyl curvature scalar of the Statistical ensemble of particle-paths ( a fluid ) associated to a single particle and that was developed by [22] . A Weyl geometric formulation of the Dirac equation and the nonlinear Klein-Gordon wave equation was provided by one of us [23]. Afterwards we will describe the interplay between Fisher Information and the Bohm's potential by introducing an action based on a *complex* momentum  $P_k = p_k + iA_k$

In the description of [22] one deals with a geometric derivation of the nonrelativistic Schroedinger Equation by relating the Bohm's quantum potential  $Q$  to the Ricci-Weyl scalar curvature of an ensemble of particle-paths associated to *one* particle. A quantum mechanical description of many particles is far more complex. This ensemble of particle paths resemble an Abelian *fluid* that permeates spacetime and whose ensemble density  $\rho$  affects the Weyl curvature of spacetime, which in turn, determines the geodesics of spacetime in guiding the particle trajectories. See [22], [23] for details).

Again a relation between the *relativistic* version of Bohm's potential  $Q$  and the Weyl-Ricci curvature exists but without the ordinary nonrelativistic probabilistic connections. In relativistic QM one does not speak of probability density to find a particle in a given spacetime point but instead one refers to the particle number current  $J^\mu = \rho dx^\mu / d\tau$ . In [22], [23] one begins with an ordinary Lagrangian associated with a point particle and whose statistical ensemble average over all particle-paths is performed only over the random initial data (configurations) . Once the initial data is specified the trajectories ( or rays ) are completely determined by the Hamilton-Jacobi equations. The statistical average over the random initial Cauchy data is performed by means of the ensemble density  $\rho$ . It is then shown that the Schroedinger equation can be derived after using the Hamilton-Jacobi equation in conjunction with the continuity equation and where the "quantum force" arising from Bohm's quantum potential  $Q$  can be related to (or described by) the Weyl geometric properties of space. To achieve this one defines the Lagrangian

$$L(q, \dot{q}, t) = L_C(q, \dot{q}, t) + \gamma(\hbar^2/m)R(q, t). \quad (24)$$

where  $\gamma = (1/6)(d-2)/(d-1)$  is a dimension-dependent numerical coefficient and  $R$  is the Weyl scalar curvature of the corresponding  $d$ -dimensional Weyl spacetime  $M$  where the particle lives.

Covariant derivatives are defined for contravariant vectors  $V^k : V^k_{;1} = \partial_i V^k - \Gamma^k_{im} V^m$  where the Weyl connection coefficients are composed of the ordinary Christoffel connection plus terms involving the Weyl gauge field of dilatations  $A_i$ . The curvature tensor  $R^i_{mkn}$  obeys the same symmetry relations as the curvature tensor of Riemann geometry as well as the Bianchi identity. The Ricci symmetric tensor  $R_{ik}$  and the scalar curvature  $R$  are defined by the same formulas also, viz.  $R_{ik} = R^n_{ink}$  and  $R = g^{ik} R_{ik}$ .

$$R_{Weyl} = R_{Riemann} + (d-1)[(d-2)A_i A^i - 2(1/\sqrt{g})\partial_i(\sqrt{g}A^i)]. \quad (25)$$

where  $R_{Riemann}$  is the ordinary Riemannian curvature defined in terms of the Christoffel symbols without the Weyl-gauge field contribution.

In the special case that the space is flat from the Riemannian point of view, after some algebra one can show that the Weyl scalar curvature contains only the Weyl gauge field of dilatations

$$R_{Weyl} = (d-1)(d-2)(A_k A^k) - 2(d-1)(\partial_k A^k). \quad (26)$$

Now the Weyl geometrical properties are to be derived from physical principles so the  $A_i$  cannot be arbitrary but must be related to the distribution of matter encoded by the ensemble density of particle-paths  $\rho$  and can be obtained by the same (averaged) least action principle giving the motion of the particle. The minimum is to be evaluated now with respect to the class of all Weyl geometries having arbitrarily Weyl-gauge fields but with fixed metric tensor.

A variational procedure [22] yields a minimum for

$$A_i(q, t) = -\frac{1}{d-2} \partial_k(\log \rho) \Rightarrow F_{ij} = \partial_i A_j - \partial_j A_i = 0. \quad (27)$$

which means that the ensemble density  $\rho$  is Weyl-covariantly constant

$$\mathcal{D}_i \rho = 0 = \partial_i \rho + \omega(\rho) \rho A_i = 0 \Rightarrow A_i(q, t) = -\frac{1}{d-2} \partial_i(\log \rho). \quad (28)$$

where  $\omega(\rho)$  is the Weyl weight of the density  $\rho$ . Since  $A_i$  is a *total* derivative the length of a vector transported from  $A$  to  $B$  along *different* paths changes by the *same amount*. Therefore, a vector after being transported along a *closed* path does *not* change its overall length. This is of fundamental importance to be able to solve in a satisfactory manner Einstein's objections to Weyl's geometry. If the lengths were to change in a path-dependent manner as one transports vectors from point  $A$  to point  $B$ , two atomic clocks which followed different paths from  $A$  to  $B$  will tick at *different* rates upon arrival at point  $B$ .

The continuity equation is

$$\frac{\partial \rho}{\partial t} + \frac{1}{\sqrt{g}} \partial_i(\sqrt{g} \rho v^i) = 0. \quad (29)$$

In this spirit one goes next to a geometrical derivation of the Schroedinger equation . By inserting

$$A_k = -\frac{1}{d-2} \frac{\partial \log \rho}{\partial x^k}. \quad (30)$$

into

$$R_{Weyl} = (d-1)(d-2)(A_k A^k) - 2(d-1)\partial_k A^k. \quad (31)$$

one gets for the Weyl scalar curvature, in the special case that the space is flat from the Riemannian point of view, the following expression

$$R_{Weyl} = \frac{1}{2\gamma\sqrt{\rho}} (\partial_i \partial^i \sqrt{\rho}). \quad (32)$$

which is precisely equal to the Bohm's Quantum potential up to numerical factors.

The Hamilton-Jacobi equation can be written as

$$\frac{\partial S}{\partial t} + H_C(q, S, t) - \gamma \left( \frac{\hbar^2}{2m} \right) R = 0 \quad (33)$$

where the effective Hamiltonian is

$$H_C - \gamma \left( \frac{\hbar^2}{m} \right) R = \frac{1}{2m} g^{jk} p_j p_k + V - \gamma \frac{\hbar^2}{m} R = \frac{1}{2m} g^{jk} \frac{\partial S}{\partial x^j} \frac{\partial S}{\partial x^k} + V - \gamma \frac{\hbar^2}{m} R \quad (34)$$

When the above expression for the Weyl scalar curvature (Bohm's quantum potential given in terms of the ensemble density) is inserted into the Hamilton-Jacobi equation, in conjunction with the continuity equation , for a momentum given by  $p_k = \partial_k S$ , one has then a set of two nonlinear coupled partial differential equations. After some straightforward algebra, one can verify that these two coupled differential equations will lead to the Schroedinger equation after the substitution  $\Psi = \sqrt{\rho} e^{iS/\hbar}$  is made.

For example, when  $d = 3$ ,  $\gamma = 1/12$  and consequently, Bohm's quantum potential  $Q = -(\hbar^2/12m)R$  ( when  $R_{Riemann} = 0$  ) becomes

$$R = \frac{1}{2\gamma\sqrt{\rho}} \partial_i g^{ik} \partial_k \sqrt{\rho} \sim \frac{1}{2\gamma} \frac{\Delta \sqrt{\rho}}{\sqrt{\rho}} \Rightarrow Q = -\frac{\hbar^2}{2m} \frac{\Delta \sqrt{\rho}}{\sqrt{\rho}}. \quad (35)$$

as is should be and from the two coupled differential equations, the Hamilton-Jacobi and the continuity equation, they both reduce to the standard Schroedinger equation in flat space

$$i\hbar \frac{\partial \Psi(\vec{x}, t)}{\partial t} = -(\hbar^2/2m)\Delta \Psi(\vec{x}, t) + V\Psi(\vec{x}, t). \quad (36)$$

after, and only after, one defines  $\Psi = \sqrt{\rho} e^{iS/\hbar}$ .

If one had a *curved* spacetime with a nontrivial metric one would obtain the Schroedinger equation in a curved spacetime manifold by replacing the Laplace operator by the Laplace-Beltrami operator. This requires, of course, to write

the continuity and Hamilton Jacobi equations in a explicit covariant manner by using the covariant form of the divergence and Laplace operator [22] , [23]. In this way, the geometric properties of space are indeed affected by the presence of the particle and in turn the alteration of geometry acts on the particle through the quantum force  $f_i = \gamma(\hbar^2/m)\partial_i R$  which depends on the Weyl gauge potential  $A_i$  and its derivatives. It is this peculiar feedback between the Weyl geometry of space and the motion of the particle which recapture the effects of Bohm's quantum potential.

The formulation above from [22] was also developed for a derivation of the Klein-Gordon (KG) equation. The Dirac equation and Nonlinear Relativistic QM equations were found by [23] via an average action principle. The *relativistic* version of the Bohm potential (for signature  $(-, +, +, +)$ ) can be written

$$Q \sim \frac{1}{m^2} \frac{(\partial_\mu \partial^\mu \sqrt{\rho})}{\sqrt{\rho}} \quad (37)$$

in terms of the D'Alambertian operator.

To finalize this section we will explain why the Bohm-potential/Weyl scalar curvature relationship in a flat spacetime

$$Q = -\frac{\hbar^2}{2m} \frac{1}{\sqrt{\rho}} g^{ik} \partial_i \partial_k \sqrt{\rho} = \frac{\hbar^2 g^{ik}}{8m} \left( \frac{2\partial_i \partial_k \rho}{\rho} - \frac{\partial_i \rho \partial_k \rho}{\rho^2} \right). \quad (38)$$

encodes already the explicit connection between Fisher Information and the Weyl-Ricci scalar curvature  $R_{Weyl}$  (for Riemann flat spaces) after one realizes the importance of the *complex* momentum  $P_k = p_k + iA_k$  . This is typical of Electromagnetism after a minimal coupling of a charged particle (of charge  $e$ ) to the  $U(1)$  gauge field  $\mathcal{A}_k$  is introduced as follows  $\Pi_k = p_k + ie\mathcal{A}_k$ . Weyl's initial goal was to unify Electromagnetism with Gravity. It was later realized that the gauge field of Weyl's dilatations  $A$  was *not* the same as the  $U(1)$  gauge field of Electromagnetism  $\mathcal{A}$ .

Since we have reviewed the relationship between the Weyl scalar curvature and Bohm's Quantum potential, it is not surprising to find automatically a connection between Fisher information and Weyl Geometry after a *complex* momentum  $P_k = p_k + iA_k$  is introduced. A complex momentum has already been discussed in previous sections within the context of fractal trajectories moving forwards and backwards in time by Nottale and Ord.

If  $\rho$  is defined over an  $d$ -dimensional manifold with metric  $g^{ik}$  one obtains a natural definition of the Fisher information associated with the ensemble density  $\rho$

$$I = g^{ik} I_{ik} = \frac{g^{ik}}{2} \int \frac{1}{\rho} \frac{\partial \rho}{\partial y^i} \frac{\partial \rho}{\partial y^k} d^n y. \quad (39)$$

In the Hamilton-Jacobi formulation of classical mechanics the equation of motion takes the form

$$\frac{\partial S}{\partial t} + \frac{1}{2m} g^{jk} \frac{\partial S}{\partial x^j} \frac{\partial S}{\partial x^k} + V = 0. \quad (40)$$

The momentum field  $p^j$  is given by  $p^j = g^{jk}(\partial S/\partial x^k)$ . The ensemble probability density of particle-paths  $\rho(t, x^\mu)$  obeys the normalization condition  $\int d^n x \rho = 1$ . The continuity equation is

$$(\partial\rho/\partial t) + \frac{1}{m} \frac{1}{\sqrt{g}} (\partial/\partial x^j) (\sqrt{g} \rho g^{jk} (\partial S/\partial x^k)) = 0. \quad (41)$$

These equations completely describe the motion and can be derived from the action

$$S = \int \rho \left\{ (\partial S/\partial t) + \frac{1}{2m} g^{jk} (\partial S/\partial x^j) (\partial S/\partial x^k) + V \right\} dt d^n x. \quad (42)$$

using fixed endpoint variation in  $S$  and  $\rho$ .

The Quantization via the Weyl geometry procedure is obtained by defining the *complex* momentum in terms of the Weyl gauge field of dilatations  $A_k$  as  $P_k = p_k + ieA_k$  and constructing the modified Hamiltonian in terms of the norm-squared of the *complex* momentum  $P^k P_k^*$  as follows

$$H_{Weyl} = \frac{g^{jk}}{2m} [(p_j + ieA_j)(p_k - ieA_k)] + V \quad (43)$$

The *modified* action is now :

$$S_{Weyl} = \int dt d^n x \left[ \frac{\partial S}{\partial t} + \frac{g^{jk}}{2m} (p_j + ieA_j)(p_k - ieA_k) + V \right]. \quad (44)$$

The relationship between the Weyl gauge potential and the ensemble density  $\rho$  was

$$A_k \sim \frac{\partial \log(\rho)}{\partial x^k}. \quad (45)$$

the proportionality factors can be re-absorbed into the coupling constant  $e$  as follows  $P_k = p_k + ieA_k = p_k + i \partial_k(\log \rho)$ . Hence, when the spacetime metric is flat ( diagonal )  $g^{jk} = \delta^{jk}$ ,  $S_{Weyl}$  becomes

$$\begin{aligned} S_{Weyl} &= \int dt d^n x \frac{\partial S}{\partial t} + \frac{g^{jk}}{2m} \left[ \left( \frac{\partial S}{\partial x^j} + i \frac{\partial \log(\rho)}{\partial x^j} \right) \left( \frac{\partial S}{\partial x^k} - i \frac{\partial \log(\rho)}{\partial x^k} \right) \right] + V = \\ &\int dt d^n x \left[ \frac{\partial S}{\partial t} + V + \frac{g^{jk}}{2m} \left( \frac{\partial S}{\partial x^j} \right) \left( \frac{\partial S}{\partial x^k} \right) \right] + \frac{1}{2m} \int dt d^n x \left[ \frac{1}{\rho} \frac{\partial \rho}{\partial x^k} \right]^2. \end{aligned} \quad (46)$$

The expectation value of  $S_{Weyl}$  is

$$\begin{aligned} \langle S_{Weyl} \rangle &= \langle S_C \rangle + S_{Fisher} = \\ &\int dt d^n x \rho \left[ \frac{\partial S}{\partial t} + \frac{g^{jk}}{2m} \left( \frac{\partial S}{\partial x^j} \right) \left( \frac{\partial S}{\partial x^k} \right) + V \right] + \frac{1}{2m} \int dt d^n x \rho \left[ \frac{1}{\rho} \frac{\partial \rho}{\partial x^k} \right]^2. \end{aligned} \quad (47)$$

This is how we have reproduced the Fisher Information expression directly from the last term of  $\langle S_{Weyl} \rangle$  :

$$S_{Fisher} \equiv \frac{1}{2m} \int dt d^n x \rho \left[ \frac{1}{\rho} \frac{\partial \rho}{\partial x^k} \right]^2 \quad (48)$$

An Euler variation of the expectation value of the action  $\langle S_{Weyl} \rangle$  with respect to the  $\rho$  yields :

$$\frac{\partial S}{\partial t} + \frac{\delta \langle S_{Weyl} \rangle}{\delta \rho} - \partial_j \left( \frac{\delta \langle S_{Weyl} \rangle}{\delta (\partial_j \rho)} \right) = 0 \Rightarrow \quad (49)$$

$$\frac{\partial S}{\partial t} + V + \frac{1}{2m} g^{jk} \left[ \frac{\partial S}{\partial x^j} \frac{\partial S}{\partial x^k} + \left( \frac{1}{\rho^2} \frac{\partial \rho}{\partial x^j} \frac{\partial \rho}{\partial x^k} - \frac{2}{\rho} \frac{\partial^2 \rho}{\partial x^j \partial x^k} \right) \right] = 0 \quad (50)$$

Notice that the last term of the Euler variation

$$\frac{1}{2m} g^{jk} \left[ \left( \frac{1}{\rho^2} \frac{\partial \rho}{\partial x^j} \frac{\partial \rho}{\partial x^k} - \frac{2}{\rho} \frac{\partial^2 \rho}{\partial x^j \partial x^k} \right) \right] \quad (51)$$

is precisely the same as the Bohm's quantum potential, which in turn, is proportional to the Weyl scalar curvature. If the continuity equation is implemented at this point one can verify once again that the last equation is equivalent to the Schrödinger equation after the replacement  $\Psi = \sqrt{\rho} e^{iS/\hbar}$  is made.

Notice that in the Euler variation variation of  $\langle S_{Weyl} \rangle$  w.r.t the  $\rho$  one must include those terms involving the derivatives of  $\rho$  as follows

$$-\partial_j \left( \frac{\delta [ \rho (\partial_k \rho / \rho)^2 ]}{\delta (\partial_j \rho)} \right) = -\frac{1}{\rho} \partial_j \left( \frac{\delta (\partial_k \rho)^2}{\delta (\partial_j \rho)} \right) = -\frac{2}{\rho} \partial_j \partial^j \rho. \quad (52)$$

This explains the origins of all the terms in the Euler variation that yield Bohm's quantum potential.

Hence, to conclude, we have shown how the *last* term of the Euler variation of the averaged action  $\langle S_{Weyl} \rangle$ , that automatically incorporates the Fisher Information expression after a *complex* momentum  $P_k = p_k + i\partial_k(\log \rho)$  is introduced via the Weyl gauge field of dilations  $A_k \sim -\partial_k \log \rho$ , generates once again Bohm's potential :

$$Q \sim \left( \frac{1}{\rho^2} \frac{\partial \rho}{\partial x^j} \frac{\partial \rho}{\partial x^k} - \frac{2}{\rho} \frac{\partial^2 \rho}{\partial x^j \partial x^k} \right). \quad (53)$$

To conclude, the Quantization of a particle whose Statistical ensemble of particle-paths permeate a spacetime background endowed with a Weyl geometry allows to construct a *complex* momentum  $P_k = \partial_k S + i\partial_k(\log \rho)$  that yields automatically the Fisher Information  $S_{Fisher}$  term. The latter Fisher Information term is crucial in generating Bohm's quantum potential  $Q$  after an Euler variation of the expectation value of the  $\langle S_{Weyl} \rangle$  with respect to the  $\rho$  is performed. Once the Bohm's quantum potential is obtained one recovers the Schroedinger equation after implementing the continuity equation and performing the replacement  $\Psi = \sqrt{\rho} e^{iS/\hbar}$ . This completes the relationship among Bohm's potential, the Weyl scalar curvature *and* Fisher Information *after* introducing a *complex* momentum.

## 4 Concluding Remarks

Based on Nottale and Ord's formulation of QM from first principles; i.e. from the fractal Brownian motion of a massive particle we have derived explicitly a nonlinear Schrödinger equation. Despite the fact that the Hamiltonian is not Hermitian, real-valued energy solutions exist like the plane wave and soliton solutions found in the free particle case. The remarkable feature of the fractal approach versus *all* the Nonlinear QM equation considered so far is that the Quantum Mechanical energy functional coincides precisely with the field theory one.

It has been known for some time, see Puskarz [8], that the expression for the energy functional in nonlinear QM does *not* coincide with the QM energy functional, nor it is unique. The classic Gross-Pitavetskii NLSE (of the 1960'), based on a quartic interaction potential energy, relevant to Bose-Einstein condensation, contains the nonlinear cubic terms in the Schrödinger equation, after differentiation,  $(\psi^*\psi)\psi$ . This equation does not satisfy the Weinberg homogeneity condition [9] and also the energy functional differs from the  $E_{QM}$  by factors of two.

However, in the fractal-based NLSE there is no discrepancy between the quantum-mechanical energy functional and the field theory energy functional. Both are given by

$$H_{fractal}^{NLSE} = -\frac{\hbar^2}{2m} \frac{\alpha}{\hbar} \psi^* \nabla^2 \psi + U \psi^* \psi - i \frac{\hbar^2}{2m} \frac{\beta}{\hbar} \psi^* (\vec{\nabla} \ln \psi)^2 \psi. \quad (54)$$

This is why we push forward the NLSE derived from the fractal Brownian motion with a complex-valued diffusion coefficient. Such equation does admit plane-wave solutions with the dispersion relation  $E = \vec{p}^2/(2m)$ . It is not hard to see that after inserting the plane wave solution into the fractal-based NLSE we get (after setting  $U = 0$ ),

$$E = \frac{\hbar^2}{2m} \frac{\alpha}{\hbar} \frac{\vec{p}^2}{\hbar^2} + i \frac{\beta}{\hbar} \frac{\vec{p}^2}{2m} = \frac{\vec{p}^2}{2m} \frac{\alpha + i\beta}{\hbar} = \frac{\vec{p}^2}{2m}, \quad (55)$$

since  $\hbar = \alpha + i\beta$ . Hence, the plane-wave *is* a solution to our fractal-based NLSE (when  $U = 0$ ) with a real-valued energy and has the correct energy-momentum dispersion relation.

Soliton solutions, with real-valued energy (momentum) are of the form

$$\psi \sim [F(x - vt) + iG(x - vt)] e^{ipx/\hbar - iEt/\hbar}, \quad (56)$$

with  $F$ ,  $G$  two functions of the argument  $x - vt$  obeying a coupled set of two nonlinear differential equations.

It is warranted to study solutions when one turns-on an external potential  $U \neq 0$  and to generalize this construction to the Quaternionic Schroedinger equation [16] based on the Hydrodynamical Nonabelian-fluid Madelung's formulation of QM proposed by [26]. And, in particular, to explore further the



consequences of the Non-Hermitian Hamiltonian ( pseudo-Hermitian) associated with our NLSE (34) within the context of the so-called *PT* symmetric *complex* extensions of QM and QFT [27]. Arguments why a quantum theory of gravity should be nonlinear have been presented by [28] where a *different* nonlinear Schroedinger equation, but with a similar logarithmic dependence, was found. This equation [28] is also similar to the one proposed by Doebner and Goldin [29] from considerations of unitary representations of the diffeomorphism group.

## Acknowledgements

We acknowledge to the Center for Theoretical Studies of Physical Systems, Clark Atlanta University, Atlanta, Georgia, USA, and the Research Committee of the University of Antioquia (CODI), Medellín, Colombia for support.

## References

- [1] L. Nottale: Journal of Chaos, Solitons and Fractals **4** (3) (1994) 361; M. Celerier and L. Nottale: Dirac equation in scale relativity, hep-th/0112213.
- [2] G. N. Ord: Journal of Physics A: Math. Gen. **16** (1983) 1869.
- [3] I. Białyński-Birula, J. Mycielsky: Annal of Physics **100** (1976) 62.
- [4] M. Pardy: To the nonlinear QM. quant-ph/0111105.
- [5] D. Bohm and J. Vigier: Phys. Rev. **96** (1954) 208.
- [6] C. Castro, J. Mahecha and B. Rodriguez, "Nonlinear QM as a Fractal Brownian motion with complex diffusion constant" [ quant-ph/0202026] .
- [7] E. Madelung: Z. Physik **40** (1926) 322.
- [8] A. Staruszkiewicz: Acta Phus. Pol. **14** (1983) 907; W. Puszkarz: On the Staruszkiewicz modification of the Schrödinger equation. quant-ph/9912006.
- [9] S. Weinberg: Ann. Phys. **194** (1989) 336.
- [10] T. Petrosky, I. Prigogine: Journal of Chaos, Solitons and Fractals **4** (3) (1994) 311.
- [11] C. Castro: Journal of Chaos, Solitons and Fractals, **12** (2001) 101.
- [12] B. Gómez, S. Moore, A. Rodríguez and A. Rueda (eds): Stochastic processes applied to physics and other related fields. World Scientific, Singapore (1983).
- [13] N. A. Lemos: Phys. Lett. **78A** (1980) 237; **78A** (1980) 239.

- [14] G. C. Ghirardi, C. Omero, A. Rimini and T. Weber: *Rivista del Nuovo Cimento* **1** (1978) 1.
- [15] J. Kamesberger, J. Zeilinger: *Physica B* **151** (1988) 193.
- [16] S. L. Adler: *Quaternionic quantum mechanics and quantum fields*. Oxford University Press, Oxford (1995).
- [17] R. Yaris and P. Winkler: *J. Phys. B: Atom. Molec Phys.* **11** (1978) 1475 and **11** (1978) 1481; N. Moiseyev: *Phys. Rep.* **302** (1998) 211.
- [18] M. B. Mensky: *Phys. Lett. A* **196** (1995) 159.
- [19] D. S. Abrams and S. Lloyd: *Phys. Rev. Lett.* **81** (1998) 3992.
- [20] J. Cresson, " Scale Calculus and the Schrodinger Equation " [ arXiv : math.GM/0211071 ].
- [21] C. Castro , " Foundations of Physics. **8** ( 2000 ) 1301; *Jour. Chaos, Solitons and Fractals* **11** (11) (2000) 1663-1670 ; C. Castro, M. Pavsic , "The Extended Relativity Theory in Clifford-spaces", *Progress in Physics* vol 1 (2005) 31. C. Castro, *Foundations of Physics* vol. 35, no. 6 (2005) 971.
- [22] E. Santamato, *Phys. Rev. D* **29** ( 1984 ) 216. *Phys. Rev. D* **32** ( 1985 ) 2615. *Jour. Math. Phys.* **25** ( 1984 ) 2477.
- [23] C. Castro, *Foundations of Physics* **22** (1992 ) 569. *Foundations of Physics Letters* **4** ( 1991 ) 81. *Jour. Math. Physics.* **31** no. 11 (1990) 2633.
- [24] B. Frieden, " Physics from Fisher Information" ( Cambridge University Press 1998 ) M. Hall, M. Reginatto, *Jour. Phys. A* **35** ( 2002 ) 3829. B. Frieden, A. Plastino, A.R Plastino and B. Soffer, " A Schrödinger link between non-equilibrium thermodynamics and Fisher information" cond-mat/0206107.
- [25] R. Carroll, " Fisher, Kahler, Weyl and the Quantum Potential" quant-ph/0406203. "Remarks on the Schroedinger Equation" quant-ph/0401082.
- [26] P. Love, B. Boghosian, " Quaternionic Madelung Transformation and Non-abelian Fluid Dynamics" hep-th/0210242.
- [27] C.Bender, " Introduction to PT-Symmetric Quantum Theory" [quant-ph/0501052] C. Bender, I. Cavero-Pelaez, K. A. Milton, K. V. Shajesh "PT-Symmetric Quantum Electrodynamics" [ hep-th/0501180 ]
- [28] T. Singh, S. Gutti and R. Tibrewala, " Why Quantum Gravity should be Nonlinear" [ arXiv. org : gr-qc/0503116].
- [29] H. Doebner and G. Goldin, *Phys. Letts A* **162** ( 1992 ) 397.

# Does Weyl's Geometry solve the Riddle of Dark Energy ?

Carlos Castro

August, 2006

Center for Theoretical Studies of Physical Systems, Clark Atlanta University, Atlanta;  
castro@ctsps.cau.edu

## Abstract

We rigorously prove why the proper use of Weyl's Geometry within the context of Friedman-Lemaitre-Robertson-Walker cosmological models can account for *both* the *origins* and the *value* of the observed vacuum energy density ( dark energy ). The source of dark energy is just the dilaton-like Jordan-Brans-Dicke scalar field that is required to implement Weyl invariance of the most *simple* of all possible actions. A *nonvanishing* value of the vacuum energy density of the order of  $10^{-123}M_{Planck}^4$  is derived in agreement with the experimental observations. The full theory involving the dynamics of Weyl's gauge field  $A_\mu$  is very rich and may explain the anomalous Pioneer acceleration and the temporal variations ( over cosmological scales ) of the fundamental constants resulting from the expansion of the Universe. This is consistent with Dirac's old idea of the plausible variation of the physical constants but with the advantage that it is *not* necessary to invoke extra dimensions.

The problem of dark energy is one of the most challenging problems facing us today, see [1], [3] for a review. In this letter we will show how Weyl's geometry (and its scaling symmetry) is instrumental to solve this dark energy riddle. Before starting we must emphasize that our procedure is quite different than previous proposals [4] to explain dark matter ( instead of dark energy ) in terms of Brans-Dicke gravity. It is not only necessary to include the Jordan-Brans-Dicke scalar field  $\phi$  but it is essential to have a Weyl geometric extension and generalization of Riemannian geometry ( ordinary gravity ). It will be shown why the scalar  $\phi$  has a *nontrivial* energy density despite having *trivial* dynamics due entirely to its potential energy density  $V(\phi = \phi_o)$  and which is precisely equal to the observed vacuum energy density of the order of  $10^{-123}M_{Planck}^4$ . For other approaches to solve the riddle of dark energy and dark matter based on modifications of gravity by starting with Lagrangians of the type  $f(\mathcal{R})$  see [12], [14], [11] and references therein.

Weyl's geometry main feature is that the norm of vectors under parallel infinitesimal displacement going from  $x^\mu$  to  $x^\mu + dx^\mu$  change as follows  $\delta||V|| \sim ||V||A_\mu dx^\mu$  where

$A_\mu$  is the Weyl gauge field of scale calibrations that behaves as a connection under Weyl transformations :

$$A'_\mu = A_\mu - \partial_\mu \Omega(x). \quad g_{\mu\nu} \rightarrow e^{2\Omega} g_{\mu\nu}. \quad (1)$$

involving the Weyl scaling parameter  $\Omega(x^\mu)$  .

The Weyl covariant derivative operator acting on a tensor  $\mathbf{T}$  is defined by  $D_\mu \mathbf{T} = (\nabla_\mu + \omega(\mathbf{T}) A_\mu) \mathbf{T}$ ; where  $\omega(\mathbf{T})$  is the Weyl weight of the tensor  $\mathbf{T}$  and the derivative operator  $\nabla_\mu = \partial_\mu + \Gamma_\mu$  involves a connection  $\Gamma_\mu$  which is comprised of the ordinary Christoffel symbols plus extra  $A_\mu$  terms in order for the metric to obey the condition  $D_\mu(g_{\nu\rho}) = 0$ . The Weyl weight of the metric  $g_{\nu\rho}$  is 2. The meaning of  $D_\mu(g_{\nu\rho}) = 0$  is that the angle formed by two vectors remains the same under parallel transport despite that their lengths may change. This also occurs in conformal mappings of the complex plane.

The Weyl covariant derivative acting on a scalar  $\phi$  of Weyl weight  $\omega(\phi) = -1$  is defined by

$$D_\mu \phi = \partial_\mu \phi + \omega(\phi) A_\mu \phi = \partial_\mu \phi - A_\mu \phi. \quad (2)$$

The Weyl scalar curvature in  $D$  dimensions and signature  $(+, -, -, \dots)$  is

$$\mathcal{R}_{Weyl} = \mathcal{R}_{Riemann} - (D-1)(D-2)A_\mu A^\mu + 2(D-1)\nabla_\mu A^\mu. \quad (3)$$

For a signature of  $(-, +, +, +, \dots)$  there is a *sign* change in the second and third terms due to a sign change of  $\mathcal{R}_{Riemann}$ .

The Jordan-Brans-Dicke action involving the scalar  $\phi$  and  $\mathcal{R}_{Weyl}$  is

$$S = - \int d^4x \sqrt{|g|} [ \phi^2 \mathcal{R}_{Weyl} ]. \quad (4)$$

Under Weyl scalings,

$$\mathcal{R}_{Weyl} \rightarrow e^{-2\Omega} \mathcal{R}_{Weyl}; \quad \phi^2 \rightarrow e^{-2\Omega} \phi^2. \quad (5)$$

to compensate for the Weyl scaling ( in  $4D$  ) of the measure  $\sqrt{|g|} \rightarrow e^{4\Omega} \sqrt{|g|}$  in order to render the action (4) Weyl invariant.

When the Weyl integrability condition is imposed  $F_{\mu\nu} = \partial_\mu A_\nu - \partial_\nu A_\mu = 0 \Rightarrow A_\mu = \partial_\mu \Omega$ , the Weyl gauge field  $A_\mu$  does not have dynamical degrees of freedom; it is pure gauge and barring global topological obstructions, one can choose the gauge in eq-(4)

$$A_\mu = 0; \quad \phi_0^2 = \frac{1}{16\pi G_N} = constant. \quad (6)$$

such that the action (4) reduces to the standard Einstein-Hilbert action of Riemannian geometry

$$S = - \frac{1}{16\pi G_N} \int d^4x \sqrt{|g|} [\mathcal{R}_{Riemann}(g)]. \quad (7)$$

The Weyl integrability condition  $F_{\mu\nu} = 0$  means physically that if we parallel transport a vector under a closed loop, as we come back to the starting point, the *norm* of the vector has not changed; i.e, the rate at which a clock ticks does not change after being transported

along a closed loop back to the initial point; and if we transport a clock from  $A$  to  $B$  along different paths, the clocks will tick at the same rate upon arrival at the same point  $B$ . This will ensure, for example, that the observed spectral lines of identical atoms will not change when the atoms arrive at the laboratory after taking different paths ( histories ) from their coincident starting point. If  $F_{\mu\nu} \neq 0$  Weyl geometry may be responsible for the alleged variations of the physical constants in recent Cosmological observations. A study of the Pioneer anomaly based on Weyl geometry was made by [9]. The literature is quite extensive on this topic.

Our starting action is

$$S = S_{Weyl}(g_{\mu\nu}, A_\mu) + S(\phi). \quad (8)$$

with

$$S_{Weyl}(g_{\mu\nu}, A_\mu) = - \int d^4x \sqrt{|g|} \phi^2 [ \mathcal{R}_{Weyl}(g_{\mu\nu}, A_\mu) ]. \quad (9)$$

where we define  $\phi^2 = (1/16\pi G)$ . The Newtonian coupling  $G$  is spacetime dependent in general and has a Weyl weight equal to 2. The term  $S(\phi)$  involving the Jordan-Brans-Dicke scalar  $\phi$  is

$$S_\phi = \int d^4x \sqrt{|g|} [ \frac{1}{2} g^{\mu\nu} (D_\mu\phi)(D_\nu\phi) - V(\phi) ]. \quad (10)$$

where  $D_\mu\phi = \partial_\mu\phi - A_\mu\phi$ . The FRW metric is

$$ds^2 = dt^2 - a^2(t) \left( \frac{dr^2}{1 - k(r/R_0)^2} + r^2(d\Omega)^2 \right). \quad (11a)$$

where  $k = 0$  for a 3-dim spatially flat region;  $k = \pm 1$  for regions of positive and negative constant spatial curvature, respectively. The de Sitter metric belongs to a special class of FRW metrics and it admits different forms depending on the coordinates chosen. The Friedman-Einstein-Weyl equations in the gauge  $A_\mu = (0, 0, 0, 0)$  (in units of  $c = 1$ )

$$G_{\mu\nu} = 8\pi G T_{\mu\nu}; \quad \phi^2 = \frac{1}{16\pi G}. \quad T_{\mu\nu} = - \frac{2}{\sqrt{|g|}} \frac{\delta S_{matter}}{\delta g^{\mu\nu}}. \quad (11b)$$

read

$$3\left(\frac{da/dt}{a}\right)^2 + \left(\frac{3k}{a^2 R_0^2}\right) = 8\pi G(t)\rho. \quad (12)$$

and

$$-2\left(\frac{d^2a/dt^2}{a}\right) - \left(\frac{da/dt}{a}\right)^2 - \left(\frac{k}{a^2 R_0^2}\right) = 8\pi G(t) p. \quad (13a)$$

From eqs-(12-13a) one can infer the important relation :

$$-\left(\frac{d^2a/dt^2}{a}\right) = \frac{4\pi G(t)}{3} (\rho + 3p). \quad (13b)$$

Eqs-(12-13) are the ones one must use instead of the erroneous equations posed by [9] in the partial gauge  $A_t = H(t)$ ,  $A_i = 0$ ,  $i = 1, 2, 3$  :

$$\left(\frac{da/dt}{a}\right)^2 = H^2(t) = - \left(\frac{k}{a^2 R_0^2}\right) - 3( A_t(x) A^t(x) - \frac{1}{\sqrt{|g|}}\partial_t(\sqrt{|g|}A^t) ) + \frac{8\pi G(t)}{3}\rho. \quad (14a)$$

and

$$- \left(\frac{d^2a/dt^2}{a}\right) = - \left( H^2(t) + \frac{dH}{dt} \right) = \frac{4\pi G(t)}{3} (\rho + 3p). \quad (14b)$$

The density and pressure terms should be given in terms of Weyl covariant derivatives of the scalar  $\phi$  and the potential density  $V(\phi)$ . The scalar  $\phi$  must be chosen to depend solely on time ,  $\phi(t)$ , because this is the relevant case suitable for the FRW cosmologies due to the fact that the geometry is spatially homogeneous and isotropic . The gauge choice condition imposed by [9] :  $A_t = H(t)$ ;  $A_i = 0$ ,  $i = 1, 2, 3$  is compatible with the spatial isotropy and homogeneity of the FRW models. However, despite that a non-zero value  $A_t$  was chosen by [9] there is a *residual* symmetry that is still available to gauge  $A_t$  to zero. As mentioned earlier, Weyl's integrability condition  $F_{\mu\nu} = 0$  when  $A_\mu$  is pure gauge, a total derivative, means that  $A_\mu$  does not have true dynamical degrees of freedom and *all* of its components can be gauged to zero  $A_\mu = (0, 0, 0, 0)$  barring global topological obstructions.

However, if one partially fixes the gauge  $A_t = H(t)$ ;  $A_i = 0$  like it was done in [9], one arrives at a *caveat* that was overlooked by [9] . One would arrive at a deep *contradiction* and *inconsistency* between the left hand side (l.h.s) and the right hand side (r.h.s) of the Friedman-Einstein-Weyl equations ( for example in eq-(14b) ) in the partially fixed gauge  $A_t = H(t)$  because the l.h.s does *not* transform homogeneously under Weyl scalings, whereas the r.h.s does; if the quantities  $\rho$  and  $p$  were to transform properly under Weyl scalings, homogeneously, this behaviour would be *incompatible* with the transformation properties of the  $A_t = H(t)$  terms appearing in the l.h.s of eqs-(14b).

In order to *reconcile* this *incompatibility* between the *inhomogeneous* transformation properties of the l.h.s of eq-(14b) with the homogeneous transformation properties of the r.h.s of (14b), *one must fix* the gauge  $A_\mu = 0$  fully in the Einstein-Friedman-Weyl equations as shown in eqs-(12-13). The latter equations *are* the physically relevant and *not* eqs-(14). One may be inclined to say : if one is going to fix the gauge  $A_\mu = 0$  anyway, then *what* is the role of Weyl's geometry and symmetry in all of this ? We will show below why despite fixing the gauge  $A_\mu = 0$  one cannot forget the *constraint* which arises from the variations of the action w.r.t the Weyl's field  $A_\mu$  ! This constraint holds the key to see why the density and pressure associated with the scalar  $\phi$  obey the sought after relation  $\rho(\phi) = -p(\phi)$  ( which is the hallmark of dark energy ) as we intend to prove next.

The Jordan-Brans-Dicke scalar  $\phi$  must obey the generalized Klein-Gordon equations of motion

$$\left( D_\mu D^\mu + 2\mathcal{R}_{Weyl} \right) \phi + \left( \frac{dV}{d\phi} \right) = 0 \quad (15)$$

notice that because the Weyl covariant derivative obeys the condition  $D_\mu(g_{\nu\rho}) = 0 \Rightarrow D_\mu(\sqrt{|g|}) = 0$  there are *no* terms of the form  $(D_\mu\sqrt{|g|})(D^\mu\phi)$  in the generalized Klein-Gordon equation like it would occur in ordinary Riemannian geometry  $(\partial_\mu\sqrt{|g|})(\partial^\mu\phi) \neq 0$ . In addition, we have the crucial *constraint* equation obtained from the variation of the action w.r.t to the  $A^\mu$  field :

$$\frac{\delta S}{\delta A^\mu} = 0 \Rightarrow 6 (A_\mu\phi^2 + \partial_\mu(\phi^2)) + \frac{1}{2} (A_\mu\phi^2 - \partial_\mu(\phi)^2) = 0. \quad (16)$$

The last constraint equation in the gauge  $A_\mu = 0$ , forces  $\partial_\mu\phi = 0 \Rightarrow \phi = \phi_o = \text{constant}$ . Consequently  $G \sim \phi^{-2}$  is also constrained to a constant  $G_N$  and one may set  $16\pi G_N \phi_o^2 = 1$ , where  $G_N$  is the observed Newtonian constant today.

Furthermore, in the gauge  $A_\mu = 0$ , due to the constraint eq-(16), one can infer that  $D_\mu\phi = 0, \Rightarrow D^\mu D_\mu\phi = 0$  because  $D_t \phi(t) = \partial_t \phi - A_t \phi = \partial_t \phi = 0$ , and  $D_i\phi(t) = -A_i\phi(t) = 0$ . These results will be used in the generalized Klein-Gordon equation.

Therefore, the stress energy tensor  $T_\mu^\mu = \text{diag} (\rho, -p, -p, -p)$  corresponding to the constant scalar field configuration  $\phi(t) = \phi_o$ , in the  $A_\mu = 0$  gauge, becomes :

$$\rho_\phi = \frac{1}{2}(\partial_t \phi - A_t \phi)^2 + V(\phi) = V(\phi); \quad p_\phi = \frac{1}{2}(\partial_t \phi - A_t \phi)^2 - V(\phi) = -V(\phi). \quad (17)$$

$$\rho + 3p = 2 (\partial_t \phi - A_t \phi)^2 - 2V(\phi) = -2V(\phi). \quad (18)$$

This completes the proof why the above  $\rho$  and  $p$  terms, in the gauge  $A_\mu = 0$ , become  $\rho(\phi) = V(\phi) = -p(\phi)$  such that  $\rho + 3p = -2V(\phi)$  ( that will be used in the Einstein-Friedman-Weyl equations (13b) ). This is the *key* reason why Weyl's geometry and symmetry is essential to explain the origins of a *non - vanishing* vacuum energy ( dark energy ). The latter relation  $\rho(\phi) = V(\phi) = -p(\phi)$  is the *key* to derive the vacuum energy density in terms of  $V(\phi = \phi_o)$ , because such relation resembles the dark energy relation  $p_{DE} = -\rho_{DE}$ . Had one not had the constraint condition  $D_t \phi(t) = (\partial_t - A_t)\phi = \partial_t \phi = 0$ , and  $D_i\phi(t) = -A_i\phi(t) = 0$ , in the gauge  $A_\mu = 0$ , enforcing  $\phi = \phi_o$ , one would not have been able to deduce the crucial condition  $\rho(\phi = \phi_o) = -p(\phi = \phi_o) = V(\phi = \phi_o)$  that will furnish the observed vacuum energy density today.

We will find now solutions of the Einstein-Friedman-Weyl equations in the gauge  $A_\mu = (0, 0, 0, 0)$  after having explained why  $A_\mu$  can (and must) be gauged to zero. The most relevant case corresponding to de Sitter space :

$$a(t) = e^{H_o t}; \quad A_\mu = (0, 0, 0, 0); \quad k = 0; \quad \mathcal{R}_{Weyl} = \mathcal{R}_{Riemann} = -12 H_o^2; \quad . \quad (19)$$

where we will show that the potential is

$$V(\phi) = 12H_o^2\phi^2 + V_o. \quad (20)$$

one learns in this case that  $V(\phi = \phi_o) \neq 0$  since this non-vanishing value is precisely the one that shall furnish the observed vacuum energy density today ( as we will see below ) . We shall begin by solving the Einstein-Friedman-Weyl equations eq-(12-13) in the gauge

$A_\mu = (0, 0, 0, 0)$  for a spatially flat universe  $k = 0$  and  $a(t) = e^{H_0 t}$ , corresponding to de Sitter metric :

$$ds^2 = dt^2 - e^{2H_0 t} (dr^2 + r^2(d\Omega)^2). \quad (21)$$

the Riemannian scalar curvature when  $k = 0$  is

$$\mathcal{R}_{Riemann} = -6 \left[ \left( \frac{d^2 a / dt^2}{a} \right) + \left( \frac{da / dt}{a} \right)^2 \right] = -12 H_0^2 \quad (22)$$

( the negative sign is due to the chosen signature  $+, -, -, -$  ).

To scalar Weyl curvature  $\mathcal{R}_{Weyl}$  in the gauge  $A_\mu = (0, 0, 0, 0)$  is the same as the Riemannian one  $\mathcal{R}_{Weyl} = \mathcal{R}_{Riemann} = -12 H_0^2$ . Inserting the condition  $D_\mu \phi = D_t \phi(t) = (\partial_t \phi - A_t \phi) = \partial_t \phi = 0$ , in the gauge  $A_\mu = 0$ , the generalized Klein-Gordon equation (3.20) will be satisfied if, and only if, the potential density  $V(\phi)$  is chosen to satisfy

$$(12 H_0^2) \phi = \frac{1}{2} \left( \frac{dV}{d\phi} \right) \Rightarrow V(\phi) = 12 H_0^2 \phi^2 + V_o \quad (23)$$

One must firstly differentiate w.r.t the scalar  $\phi$ , and only afterwards, one may set  $\phi = \phi_o$ .  $V(\phi)$  has a Weyl weight equal to  $-4$  under Weyl scalings in order to ensure that the full action is Weyl invariant.  $H_0^2$  and  $\phi_o^2$  have both a Weyl weight of  $-2$ , despite being constants, because as one performs a Weyl scaling of these quantities ( a change of a scales) they will acquire then a spacetime dependence.  $H_0^2$  is a masslike parameter, one may interpret  $H_0^2$  ( up to numerical factors ) as the "mass" squared of the Jordan-Brans-Dicke scalar. We will see soon why the integration constant  $V_o$  plays the role of the "cosmological constant".

An important remark is in order. Even if we included other forms of matter in the Einstein-Fredmann-Weyl equations, in the very large  $t$  regime, their contributions will be *washed* away due to their scaling behaviour. We know that ordinary matter (  $p = 0$  ); dark matter (  $p_{DM} = w\rho_{DM}$  with  $-1 < w < 0$  ) and radiation terms (  $p_{rad} = \frac{1}{3}\rho_{rad}$  ) are all *washed* away due to their scaling behaviour :

$$\rho_{matter} \sim R(t)^{-3}. \quad \rho_{radiation} \sim R(t)^{-4}. \quad \rho_{DM} \sim R(t)^{-3(1+w)}. \quad (24)$$

where  $R(t) = a(t)R_0$ . The dark energy density remains *constant* with scale since  $w = -1$  and the scaling exponent is zero,  $\rho_{DE} \sim R^0 = constant$ . For this reason it is the only contributing factor at very large times.

Now we are ready to show that eqs-(12-13) are indeed satisfied when  $a(t) = e^{H_0 t}$ ;  $k = 0$ ;  $A_\mu = 0$ ;  $\phi = \phi_o \neq 0$ . Eq-(13b), due to the conditions  $\rho + 3p = -2V(\phi)$  and  $\phi(t) = \phi_o$  (resulting from the constraint eq-(16) in the  $A_\mu = 0$  gauge ) gives :

$$\begin{aligned} - \left( \frac{d^2 a / dt^2}{a} \right) &= - H_0^2 = \frac{4\pi G_N}{3} (\rho + 3p) = \\ - \left( \frac{8\pi G_N V(\phi = \phi_o)}{3} \right) &= - \left( \frac{8\pi G_N 12 H_0^2 \phi_o^2}{3} \right) - \frac{8\pi G_N V_o}{3}. \end{aligned} \quad (25)$$



Eq-(12) ( with  $k = 0$  ) is just the same as eq-(13b) but with an overall *change* of sign because  $\rho(\phi = \phi_o) = V(\phi = \phi_o)$ . Using the definition  $16\pi G_N \phi_o^2 = 1$  in (25) one gets

$$-H_0^2 = -\left(\frac{8\pi G_N 12 H_0^2 \phi_o^2}{3}\right) - \frac{8\pi G_N V_o}{3} = -2 H_0^2 - \frac{8\pi G_N V_o}{3} \Rightarrow$$

$$-\frac{8\pi G_N V_o}{3} = H_0^2 \Rightarrow -8\pi G_N V_o = 3 H_0^2 \quad (26)$$

Therefore, we may identify the term  $-V_o$  with the vacuum energy density so the quantity  $3H_0^2 = -8\pi G_N V_o = \Lambda$  is nothing but the cosmological constant. It is *not surprising* at all to obtain  $\Lambda = 3 H_0^2$  in de Sitter space . One knew it long ago. What is most *relevant* about eq-(26) is that the observed vacuum energy density is minus the *constant* of integration  $V_o$  corresponding to the potential density  $V(\phi) = 12H^2\phi^2 + V_o$  !. Hence one has from the last term of eq-(26) :

$$-V_o = \rho_{vacuum} = \frac{3H_0^2}{8\pi G_N}. \quad (27)$$

and finally, when we set  $H_0^2 = (1/R_0^2) = (1/R_{Hubble}^2)$  and  $G_N = L_{Planck}^2$  in the last term of eq-(26), as announced, the vacuum density  $\rho_{vacuum}$  observed today is *precisely* given by :

$$-V_o = \rho_{vacuum} = \frac{3H_0^2}{8\pi G_N} = \frac{3}{8\pi} (L_{Planck})^{-2} (R_{Hubble})^{-2} =$$

$$\frac{3}{8\pi} \left(\frac{1}{L_{Planck}}\right)^4 \left(\frac{L_{Planck}}{R_{Hubble}}\right)^2 \sim 10^{-123} (M_{Planck})^4. \quad (28)$$

This completes our third derivation of the vacuum energy density given by the formula (26-28). The first derivation was attained in [5], while the second derivation was attained in [6] .

Concluding this analysis of the Einstein-Friedman-Weyl eqs-(12-13) : By invoking the principle of Weyl scaling symmetry in the context of Weyl's geometry; when  $k = 0$  ( spatially flat Universe ),  $a(t) = e^{H_0 t}$  ( de Sitter inflationary phase ) ;  $H_o =$  Hubble constant today;  $\phi(t) = \phi_o = constant$ , such  $16\pi G_N \phi_o^2 = 1$ , one finds that

$$V(\phi = \phi_o) = 12 H_0^2 \phi_o^2 + V_o = 2\rho_{vacuum} - \rho_{vacuum} = \rho_{vacuum} =$$

$$6H_0^2\phi_o^2 = \frac{3H_0^2}{8\pi G_N} \sim 10^{-123} M_{Planck}^4. \quad (29)$$

is precisely the observed vacuum energy density (28) . Therefore, the observed vacuum energy density is intrinsically and inexorably linked to the potential density  $V(\phi = \phi_o)$  corresponding to the Jordan-Brans-Dicke scalar  $\phi$  required to build Weyl invariant actions and evaluated at the special point  $\phi_o^2 = (1/16\pi G_N)$ .

The case of an *ever expanding accelerating universe* ( consistent with observations) is so promising because it incorporates the presence of the Hubble Scale and Planck scale into the expression for the observed vacuum energy density via the Jordan-Brans-Dicke scalar field  $\phi$  needed to implement Weyl invariance of the action. Weyl's scaling

symmetry principle permits us to explain *why* the observed value of the vacuum energy density  $\rho_{vacuum}$  is *precisely* given by the expression (28-29).

In order to introduce true dynamics to the Weyl gauge field, one must add the kinetic term for the Weyl gauge field  $F_{\mu\nu}F^{\mu\nu}$ . In this case, the integrability condition  $F_{\mu\nu} = \partial_\mu A_\nu - \partial_\nu A_\mu = 0$  is *no* longer obeyed in general and the rate at which clocks tick may depend on their worldline history. This could induce a variation of the physical constants ( even dimensionless constants like the fine structure constant  $\alpha = 1/137$  ). For instance, as the size of the universe grows, (  $a(t) = e^{H_0 t}$  increases with time) the variable speed of light, Newtonian coupling and cosmological constant , may vary according to the law  $[G(t)/c^4(t) \Lambda(t)] \sim (1/\rho_{vacuum})$  if the vacuum energy density  $\rho_{vacuum}$  would remain constant. Many authors have speculated about this last behaviour among  $c, G, \Lambda$  as well as the possibility that an explanation of the Pioneer anomaly could be due to the accelerated expansion of the universe that accounts for an acceleration of  $c^2/R_{Hubble}$ , if one views our solar system as non-expanding "pennies" in an expanding balloon.

The most general Lagrangian involving dynamics for  $A_\mu$  is

$$\mathcal{L} = -\phi^2 \mathcal{R}_{Weyl}(g_{\mu\nu}, A_\mu) + \frac{1}{4} F_{\mu\nu} F^{\mu\nu} + \frac{1}{2} g^{\mu\nu} (D_\mu \phi)(D_\nu \phi) - V(\phi) + L_{matter} + \dots \quad (30)$$

The  $L_{matter}$  must involve the full fledged Weyl gauge covariant derivatives acting on scalar and spinor fields contrary to the Cheng-Weyl models of [10] where there is no Weyl gauge field in the derivatives.  $L_{radiation}$  terms may be included involving the Maxwell field  $\mathcal{A}_\mu$  which must not be confused with the Weyl gauge field  $A_\mu$ . One could also add Yang-Mills fields  $\mathcal{A}_\mu^a$  and kinetic and potential terms for the Higgs scalars as well. The simplest scenario, of course, was the one given in this section.

There are many differences among our approach to explain the origins of dark energy and that of [7], [2], [3], [1], [10], [13], to cite a few. The Cheng-Weyl approach [10] to account for dark energy and matter ( including phantom ) does *not* use the Weyl scalar curvature with a variable Newtonian coupling  $16\pi G = \phi^{-2}$  for the gravitational part of the action, but the ordinary Riemannian scalar curvature with the standard Newtonian gravitational constant . Conformal transformations in accelerated cosmologies have been studied by [11] but their approach is different than the Weyl geometric one presented here. Weyl invariance has been used in [8] to construct Weyl-Conformally Invariant Light-Like p-Brane Theories with numerous applications in Astrophysics, Cosmology, Particle Physics Model Building, String theory,.....

To end this work, we just point out the known fact that the electron neutrino mass  $m_\nu \sim 10^{-3} eV$  is of the same order as  $(m_\nu)^4 \sim 10^{-123} M_{Planck}^4$  and that the SUSY breaking scale in many models is given by a geometric mean relation :  $m_{SUSY}^2 = m_\nu M_{Planck} \sim (5 TeV)^2$ . For interesting remarks on the fundamental constants see [15]. We hope that the contents of this work will help us elucidate further the connection between the microscopic and macroscopic world.

### Acknowledgments

We are indebted to M. Bowers for assistance .

## References

- [1] T. Padmanabhan, " Dark Energy : Mystery of the Millenium" astro-ph/0603114.
- [2] E. I. Guendelman and A. B. Kaganovich, "k-Essence, Avoidance of the Weinberg's Cosmological Constant No-Go Theorem and Other Dark Energy Effects of Two Measures Field Theory", gr-qc/0606017.
- [3] N. Mavromatos, " The issue of Dark Energy in Strng Theory" hep-th/0607006.
- [4] H. Kim, " Can the Brans-Dicke gravity possibly with  $\Lambda$  be a theory of Dark matter ? " astro-ph/0604055. M. Arik and M. Calik, " Can Brans-Dicke scalar field account for dark energy and dark matter ? gr-qc/0505035.
- [5] C. Castro, Mod. Phys. Lett **A17** (2002) 2095-2103
- [6] C. Castro, "On Novel Static Spherically Symmetric Solutions of Einstein equations and the Cosmological Constant Problem " CTSPS preprint, May 2006, submitted to the IJMPD.
- [7] L. Nottale, *Fractal Spacetime and Micrphysics : Towards Scale Relativity* ( World Scientific, Singapore, 1992 )
- [8] E. Guendelman, A. Kaganovich, Phys. Rev **D 53** (1996) 7020; Phys. Rev **D 60** , 065004 ( 1999 ) ; Int. J. Mod. Phys **A 17** (2002) 417; E. Guendelman, A. Kaganovich, E. Nissimov and S. Pacheva, " Weyl-Conformally Invariant Light-Like p-Brane Theories " hep-th/0409078.
- [9] E. Scholz, " On the Geometry of Cosmological Model Building" gr-qc/0511113
- [10] H. Wei and R-G Cai, " Cheng-Weyl Vector Field and Cosmological Application" astro-phy/0607064.
- [11] J. Crooks and P. Frampton, " Conformal Transformations and Accelerated Cosmologies " astro-ph/0601051. M.Cardoni, " Conformal Symmetry of Gravity and the Cosmological Constant Problem" hep-th/0606274.
- [12] S. Capozziello, V. Cardone and A. Troisi, " Jour. of Cosmology and Astroparticle Physics **08** (2006) 001.
- [13] H. Brandt, J. Modern Optics 51, 2753-2759 (2004).
- [14] S. Capozziello, S. Nojiri and S. Odintsov, Phys. Letts **B 634** (2006) 93.
- [15] J. Nieto, " S-duality for Linearized Gravity" hep-th/9910049. J. Nieto, L. Ruiz and J. Silvas, " Thoughts on Duality and the Fundamental Constants" hep-th/0512256.

# THE EXTENDED RELATIVITY THEORY IN CLIFFORD SPACES

C. Castro<sup>a</sup> and M. Pavšič<sup>b</sup>

January 2004, Revised January 2005 \*

## Abstract

An introduction to some of the most important features of the Extended Relativity theory in Clifford-spaces ( $C$ -spaces) is presented whose "point" coordinates are non-commuting Clifford-valued quantities which incorporate lines, areas, volumes, hyper-volumes.... degrees of freedom associated with the collective particle, string, membrane, p-brane,... dynamics of  $p$ -loops (closed p-branes) in target  $D$ -dimensional spacetime backgrounds.  $C$ -space Relativity naturally incorporates the ideas of an invariant length (Planck scale), maximal acceleration, non-commuting coordinates, supersymmetry, holography, higher derivative gravity with torsion and variable dimensions/signatures. It permits to study the dynamics of all (closed) p-branes, for all values of  $p$ , on a unified footing. It resolves the ordering ambiguities in QFT, the problem of time in Cosmology and admits superluminal propagation (tachyons) without violations of causality. A discussion of the maximal-acceleration Relativity principle in phase-spaces follows and the study of the invariance group of symmetry transformations in phase-space allows to show why Planck areas are *invariant* under acceleration-boosts transformations. This invariance feature suggests that a maximal-string tension principle may be operating in Nature. We continue by pointing out how the relativity of signatures of the underlying  $n$ -dimensional spacetime results from taking different  $n$ -dimensional slices through  $C$ -space. The conformal group in spacetime emerges as a natural subgroup of the Clifford group and Relativity in  $C$ -spaces involves natural *scale* changes in the sizes of physical objects without the introduction of forces nor Weyl's gauge field of dilations. We finalize by constructing the generalization of Maxwell theory of Electrodynamics of point charges to a theory in  $C$ -spaces that involves extended charges coupled to antisymmetric tensor fields of arbitrary rank. In the concluding remarks we outline briefly the current promising research programs and their plausible connections with  $C$ -space Relativity.

---

\*<sup>a</sup>Center for Theoretical Studies of Physical Systems, Clark Atlanta University, Atlanta <sup>b</sup>Jožef Stefan Institute, Jamova 39, SI-1000 Ljubljana, Slovenia

# 1 Introduction

In recent years it was argued that the underlying fundamental physical principle behind string theory, not unlike the principle of equivalence and general covariance in Einstein's general relativity, might well be related to the existence of an invariant minimal length scale (Planck scale) attainable in nature [8]. A theory involving spacetime *resolutions* was developed long ago by Nottale [23] where the Planck scale was postulated as the minimum observer independent invariant resolution [23] in Nature. Since "points" cannot be observed physically with an ultimate resolution, it is reasonable to postulate that they are smeared out into fuzzy balls. In refs.[8] it was assumed that those balls have the Planck radius and arbitrary dimension. For this reason it was argued in refs.[8] that one should construct a theory which includes all dimensions (and signatures) on the equal footing. In [8] this Extended Scale Relativity principle was applied to the quantum mechanics of  $p$ -branes which led to the construction of Clifford-space ( $C$ -space) where all  $p$ -branes were taken to be on the same footing, in the sense that the transformations in  $C$ -space reshuffled a string history for a five-brane history, a membrane history for a string history, for example.

Clifford algebras contained the appropriate algebraic-geometric features to implement this principle of polydimensional transformations [14]–[17]. In [14]–[16] it was proposed that every physical quantity is in fact a *polyvector*, that is, a Clifford number or a Clifford aggregate. Also, spinors are the members of left or right minimal ideals of Clifford algebra, which may provide the framework for a deeper understanding of supersymmetries, i.e., the transformations relating bosons and fermions. The Fock-Stueckelberg theory of a relativistic particle can be embedded in the Clifford algebra of spacetime [15, 16]. Many important aspects of Clifford algebra are described in [1],[6], [7], [3], [15, 16, 17], [5], [48]. It is our belief that this may lead to the proper formulation of string and M theory.

A geometric approach to the physics of the Standard Model in terms of Clifford algebras was advanced by [4]. It was realized in [43] that the  $Cl(8)$  Clifford algebra contains the 4 fundamental nontrivial representations of  $Spin(8)$  that accommodate the chiral fermions and gauge bosons of the Standard model and which also includes gravitons via the McDowell-Mansouri-Chamseddine-West formulation of gravity, which permits to construct locally, in  $D = 8$ , a geometric Lagrangian for the Standard Model plus Gravity. Furthermore, discrete Clifford-algebraic methods based on hyperdiamond-lattices have been instrumental in constructing  $E_8$  lattices and deriving the values of the force-strengths (coupling constants) and masses of the Standard model with remarkable precision by [43]. These results have recently been corroborated by [46] for Electromagnetism, and by [47], where all the Standard model parameters were obtained from first principles, despite the contrary orthodox belief that it is senseless to "derive" the values of the fundamental constants in Nature from first principles, from pure thought alone; i.e. one must invoke the Cosmological anthropic principle to explain why the constants of Nature have the values they have.

Using these methods the bosonic  $p$ -brane propagator, in the quenched mini superspace approximation, was constructed in [18, 19]; the logarithmic corrections to the black hole

entropy based on the geometry of Clifford space (in short  $C$ -space) were obtained in [21]; The modified nonlinear de Broglie dispersion relations, the corresponding minimal-length stringy [11] and  $p$ -brane uncertainty relations also admitted a  $C$ -space interpretation [10], [19]. A generalization of Maxwell theory of electromagnetism in  $C$ -spaces comprised of extended charges coupled to antisymmetric tensor fields of arbitrary rank was attained recently in [75]. The resolution of the ordering ambiguities of QFT in curved spaces was resolved by using polyvectors, or Clifford-algebra valued objects [26]. One of the most remarkable features of the Extended Relativity in  $C$ -spaces is that a higher derivative Gravity with Torsion in ordinary spacetime follows naturally from the analog of the Einstein-Hilbert action in *curved*  $C$ -space [20].

In this new physical theory the arena for physics is no longer the ordinary spacetime, but a more general manifold of Clifford algebra valued objects, noncommuting polyvectors. Such a manifold has been called a pan-dimensional continuum [14] or  $C$ -space [8]. The latter describes on a unified basis the objects of various dimensionality: not only points, but also closed lines, surfaces, volumes,..., called 0-loops (points), 1-loops (closed strings) 2-loops (closed membranes), 3-loops, etc.. It is a sort of a *dimension* category, where the role of functorial maps is played by  $C$ -space transformations which reshuffles a  $p$ -brane history for a  $p'$ -brane history or a mixture of all of them, for example. The above geometric objects may be considered as corresponding to the well-known physical objects, namely closed  $p$ -branes. Technically those transformations in  $C$ -space that reshuffle objects of different dimensions are generalizations of the ordinary Lorentz transformations to  $C$ -space.

$C$ -space Relativity involves a generalization of Lorentz invariance (and not a deformation of such symmetry) involving superpositions of  $p$ -branes ( $p$ -loops) of all possible dimensions. The Planck scale is introduced as a natural parameter that allows us to bridge extended objects of different dimensionalities. Like the speed of light was needed in Einstein Relativity to fuse space and time together in the Minkowski spacetime interval. Another important point is that the Conformal Group of four-dimensional spacetime is a consequence of the Clifford algebra in *four-dimensions* [25] and it emphasizes the fact why the natural dilations/contractions of objects in  $C$ -space is *not* the same physical phenomenon than what occurs in Weyl's geometry which requires introducing, by hand, a gauge field of dilations. Objects move dilationally, in the absence of forces, for a different physical reasoning than in Weyl's geometry: they move dilationally because of inertia. This was discussed long ago in refs.[27, 28].

This review is organized as follows: Section **2** is dedicated to extending ordinary Special Relativity theory, from Minkowski spacetime to  $C$ -spaces, where the introduction of the invariant Planck scale is required to bridge objects,  $p$ -branes, of different dimensionality.

The generalized dynamics of particles, fields and branes in  $C$ -space is studied in section **3**. This formalism allows us to construct for the first time, to our knowledge, a *unified* action which comprises the dynamics of *all*  $p$ -branes in  $C$ -spaces, for all values of  $p$ , in one single footing (see also [15]). In particular, the polyparticle dynamics in  $C$ -space, when reduced to 4-dimensional spacetime leads to the Stuckelberg formalism and the solution to the problem of time in Cosmology [15].

In section **4** we begin by discussing the geometric Clifford calculus that allows us

to reproduce all the standard results in differential and projective geometry [41]. The resolution of the ordering ambiguities of QFT in curved spaces follows next when we review how it can be resolved by using polyvectors, or Clifford-algebra valued objects [26]. Afterwards we construct the Generalized Gravitational Theories in Curved C-spaces, in particular it is shown how Higher derivative Gravity with Torsion in ordinary spacetime follows naturally from the Geometry of C-space [20].

In section 5 we discuss the Quantization program in C-spaces, and write the C-space Klein-Gordon and Dirac equations [15]. The corresponding bosonic/fermionic  $p$ -brane loop-wave equations were studied by [12], [13] without employing Clifford algebra and the concept of C-space.

In section 6 we review the Maximal-Acceleration Relativity in Phase-Spaces [127], starting with the construction of the submaximally-accelerated particle action of [53] using Clifford algebras in phase-spaces; the  $U(1, 3)$  invariance transformations [74] associated with an 8-dimensional phase space, and show why the minimal Planck-Scale areas are invariant under pure acceleration boosts which suggests that there could be a principle of maximal-tension (maximal acceleration) operating in string theory [68].

In section 7 we discuss the important point that the notion of spacetime signature is relative to a chosen  $n$ -dimensional subspace of  $2^n$ -dimensional Clifford space. Different subspaces  $V_n$ —different sections through C-space—have in general different signature [15]. We show afterwards how the Conformal algebra of spacetime emerges from the Clifford algebra [25] and emphasize the physical *differences* between our model and the one based on Weyl geometry. At the end we show how Clifford algebraic methods permits one to generalize Maxwell theory of Electrodynamics (associated with ordinary point-charges) to a generalized Maxwell theory in Clifford spaces involving *extended* charges and  $p$ -forms of arbitrary rank [75].

In the concluding remarks, we briefly discuss the possible avenues of future research in the construction of QFT in C-spaces, Quantum Gravity, Noncommutative Geometry, and other lines of current promising research in the literature.

## 2 Extending Relativity from Minkowski Spacetime to C-space

We embark into the construction of the extended relativity theory in C-spaces by a natural generalization of the notion of a spacetime interval in Minkowski space to C-space [8, 14, 16, 15, 17]:

$$dX^2 = d\sigma^2 + dx_\mu dx^\mu + dx_{\mu\nu} dx^{\mu\nu} + \dots \quad (1)$$

where  $\mu_1 < \mu_2 < \dots$ . The Clifford valued polyvector:<sup>1</sup>

$$X = X^M E_M = \sigma \underline{1} + x^\mu \gamma_\mu + x^{\mu\nu} \gamma_\mu \wedge \gamma_\nu + \dots x^{\mu_1 \mu_2 \dots \mu_D} \gamma_{\mu_1} \wedge \gamma_{\mu_2} \dots \wedge \gamma_{\mu_D}. \quad (2)$$

---

<sup>1</sup>If we do not restrict indices according to  $\mu_1 < \mu_2 < \mu_3 < \dots$ , then the factors  $1/2!$ ,  $1/3!$ , respectively, have to be included in front of every term in the expansion (1).

denotes the position of a point in a manifold, called Clifford space or  $C$ -space. The series of terms in (2) terminates at a *finite* grade depending on the dimension  $D$ . A Clifford algebra  $Cl(r, q)$  with  $r + q = D$  has  $2^D$  basis elements. For simplicity, the gammas  $\gamma^\mu$  correspond to a Clifford algebra associated with a flat spacetime:

$$\frac{1}{2}\{\gamma^\mu, \gamma^\nu\} = \eta^{\mu\nu}. \quad (3)$$

but in general one could extend this formulation to curved spacetimes with metric  $g^{\mu\nu}$  (see section 4).

The connection to strings and p-branes can be seen as follows. In the case of a closed string (a 1-loop) embedded in a target flat spacetime background of  $D$ -dimensions, one represents the projections of the closed string (1-loop) onto the embedding spacetime coordinate-planes by the variables  $x^{\mu\nu}$ . These variables represent the respective *areas* enclosed by the projections of the closed string (1-loop) onto the corresponding embedding spacetime planes. Similarly, one can embed a closed membrane (a 2-loop) onto a  $D$ -dim flat spacetime, where the projections given by the antisymmetric variables  $x^{\mu\nu\rho}$  represent the corresponding *volumes* enclosed by the projections of the 2-loop along the hyperplanes of the flat target spacetime background.

This procedure can be carried to all closed p-branes ( $p$ -loops) where the values of  $p$  are  $p = 0, 1, 2, 3, \dots$ . The  $p = 0$  value represents the center of mass and the coordinates  $x^{\mu\nu}, x^{\mu\nu\rho}, \dots$  have been *coined* in the string-brane literature [24]. as the *holographic* areas, volumes, ... projections of the nested family of  $p$ -loops (closed  $p$ -branes) onto the embedding spacetime coordinate planes/hyperplanes. In ref.[17] they were interpreted as the generalized centre of mass coordinates of an extended object. Extended objects were thus modeled in  $C$ -space.

The scalar coordinate  $\sigma$  entering a polyvector  $X$  is a measure associated with the  $p$ -brane's world manifold  $V_{p+1}$  (e.g., the string's 2-dimensional worldsheet  $V_2$ ): it is proportional to the  $(p + 1)$ -dimensional area/volume of  $V_{p+1}$ . In other words,  $\sigma$  is proportional to the areal-time parameter of the Eguchi-Schild formulation of string dynamics [126, 37, 24].

We see in this generalized scheme the objects as observed in spacetime (which is a section through  $C$ -space) need not be infinitely extended along time-like directions. They need not be infinitely long world lines, world tubes. They can be finite world lines, world tubes. The  $\sigma$  coordinate measures how long are world lines, world tubes. During evolution they can become longer and longer or shorter and shorter.

If we take the differential  $dX$  of  $X$  and compute the scalar product among two polyvectors  $\langle dX^\dagger dX \rangle_0 \equiv dX^\dagger * dX \equiv |dX|^2$  we obtain the  $C$ -space extension of the particles proper time in Minkowski space. The symbol  $X^\dagger$  denotes the *reversion* operation and involves reversing the order of all the basis  $\gamma^\mu$  elements in the expansion of  $X$ . It is the analog of the transpose (Hermitian) conjugation. The  $C$ -space proper time associated with a polyparticle motion is then the expression (1) which can be written more explicitly as:

$$\begin{aligned} |dX|^2 &= G_{MN} dX^M dX^N = dS^2 \\ &= d\sigma^2 + L^{-2} dx_\mu dx^\mu + L^{-4} dx_{\mu\nu} dx^{\mu\nu} + \dots + L^{-2D} dx_{\mu_1 \dots \mu_D} dx^{\mu_1 \dots \mu_D} \end{aligned} \quad (4)$$



where  $G_{MN} = E_M^\dagger * E_N$  is the  $C$ -space metric.

Here we have introduced the Planck scale  $L$  since a length parameter is needed in order to tie objects of different dimensionality together: 0-loops, 1-loops,...,  $p$ -loops. Einstein introduced the speed of light as a universal absolute invariant in order to “unite” space with time (to match units) in the Minkowski space interval:

$$ds^2 = c^2 dt^2 + dx_i dx^i.$$

A similar unification is needed here to “unite” objects of different dimensions, such as  $x^\mu$ ,  $x^{\mu\nu}$ , etc... The Planck scale then emerges as another universal invariant in constructing an extended relativity theory in  $C$ -spaces [8].

Since the  $D$ -dimensional Planck scale is given explicitly in terms of the Newton constant:  $L_D = (G_N)^{1/(D-2)}$ , in natural units of  $\hbar = c = 1$ , one can see that when  $D = \infty$  the value of  $L_D$  is then  $L_\infty = G^0 = 1$  (assuming a finite value of  $G$ ). Hence in  $D = \infty$  the Planck scale has the natural value of unity. However, if one wishes to avoid any serious algebraic divergence problems in the series of terms appearing in the expansion of the analog of proper time in  $C$ -spaces, in the extreme case when  $D = \infty$ , from now on we shall focus solely on a *finite* value of  $D$ . In this fashion we avoid any serious algebraic convergence problems. We shall not be concerned in this work with the representations of Clifford algebras in different dimensions and with different signatures.

The line element  $dS$  as defined in (4) is *dimensionless*. Alternatively, one can define [8, 9] the line element whose dimension is that of the  $D$ -volume so that:

$$d\Sigma^2 = L^{2D} d\sigma^2 + L^{2D-2} dx_\mu dx^\mu + L^{2D-4} dx_{\mu\nu} dx^{\mu\nu} + \dots + dx_{\mu_1 \dots \mu_D} dx^{\mu_1 \dots \mu_D} \quad (5)$$

Let us use the relation

$$\gamma_{\mu_1} \wedge \dots \wedge \gamma_{\mu_D} = \gamma \epsilon_{\mu_1 \dots \mu_D} \quad (6)$$

and write the *volume element* as

$$dx^{\mu_1 \dots \mu_D} \gamma_{\mu_1} \wedge \dots \wedge \gamma_{\mu_D} \equiv \gamma d\tilde{\sigma} \quad (7)$$

where

$$d\tilde{\sigma} \equiv dx^{\mu_1 \dots \mu_D} \epsilon_{\mu_1 \dots \mu_D} \quad (8)$$

In all expressions we assume the ordering prescription  $\mu_1 < \mu_2 < \dots < \mu_r$ ,  $r = 1, 2, \dots, D$ . The line element can then be written in the form

$$d\Sigma^2 = L^{2D} d\sigma^2 + L^{2D-2} dx_\mu dx^\mu + L^{2D-4} dx_{\mu\nu} dx^{\mu\nu} + \dots + |\gamma|^2 d\tilde{\sigma}^2 \quad (9)$$

where

$$|\gamma|^2 \equiv \gamma^\dagger * \gamma \quad (10)$$

Here  $\gamma$  is the pseudoscalar basis element and can be written as  $\gamma_0 \wedge \gamma_1 \wedge \dots \wedge \gamma_{D-1}$ . In flat spacetime  $M_D$  we have that  $|\gamma|^2 = +1$  or  $-1$ , depending on dimension and signature. In  $M_4$  with signature  $(+ - - -)$  we have  $\gamma^\dagger * \gamma = \gamma^\dagger \gamma = \gamma^2 = -1$  ( $\gamma \equiv \gamma_5 = \gamma_0 \gamma_1 \gamma_2 \gamma_3$ ), whilst in  $M_5$  with signature  $(+ - - - -)$  it is  $\gamma^\dagger \gamma = 1$ .

The analog of Lorentz transformations in C-spaces which transform a polyvector  $X$  into another poly-vector  $X'$  is given by

$$X' = RXR^{-1} \quad (11)$$

with

$$R = e^{\theta^A E_A} = \exp [(\theta I + \theta^\mu \gamma_\mu + \theta^{\mu_1 \mu_2} \gamma_{\mu_1} \wedge \gamma_{\mu_2} \dots)]. \quad (12)$$

and

$$R^{-1} = e^{-\theta^A E_A} = \exp [-(\theta I + \theta^\nu \gamma_\nu + \theta^{\nu_1 \nu_2} \gamma_{\nu_1} \wedge \gamma_{\nu_2} \dots)]. \quad (13)$$

where the theta parameters in (12)(13) are the components of the Clifford-value parameter  $\Theta = \theta^M E_M$ :

$$\theta; \theta^\mu; \theta^{\mu\nu}; \dots \quad (14)$$

they are the C-space version of the Lorentz rotations/boosts parameters.

Since a Clifford algebra admits a matrix representation, one can write the norm of a poly-vectors in terms of the trace operation as:  $\|X\|^2 = \text{Trace } X^2$  Hence under C-space Lorentz transformation the norms of poly-vectors behave like follows:

$$\text{Trace } X'^2 = \text{Trace } [RX^2R^{-1}] = \text{Trace } [RR^{-1}X^2] = \text{Trace } X^2. \quad (15)$$

These norms are invariant under C-space Lorentz transformations due to the cyclic property of the trace operation and  $RR^{-1} = 1$ . If one writes the invariant norm in terms of the *reversal* operation  $\langle X^\dagger X \rangle_s$  this will constrain the explicit form of the terms in the exponential which define the rotor  $R$  so the rotor  $R$  obeys the analog condition of an orthogonal rotation matrix  $R^\dagger = R^{-1}$ . Hence the appropriate poly-rotations of poly-vectors which preserve the norm must be :

$$\|(X')^2\| = \langle X'^\dagger X' \rangle_s = \langle (R^{-1})^\dagger X^\dagger R^\dagger R X R^{-1} \rangle_s = \langle R X^\dagger X R^{-1} \rangle_s = \langle X^\dagger X \rangle_s = \|X^2\|. \quad (16)$$

where once again, we made use of the analog of the cyclic property of the trace,  $\langle R X^\dagger X R^{-1} \rangle_s = \langle X^\dagger X \rangle_s$ .

This way of rewriting the inner product of poly-vectors by means of the reversal operation that reverses the order of the Clifford basis generators :  $(\gamma^\mu \wedge \gamma^\nu)^\dagger = \gamma^\nu \wedge \gamma^\mu$ , etc... has some subtleties. The analog of an orthogonal matrix in Clifford spaces is  $R^\dagger = R^{-1}$  such that

$$\langle X'^\dagger X' \rangle_s = \langle (R^{-1})^\dagger X^\dagger R^\dagger R X R^{-1} \rangle_s = \langle R X^\dagger X R^{-1} \rangle_s = \langle X^\dagger X \rangle_s = \text{invariant}.$$

This condition  $R^\dagger = R^{-1}$ , of course, will *restrict* the type of terms allowed inside the exponential defining the rotor  $R$  because the *reversal* of a  $p$ -vector obeys

$$(\gamma_{\mu_1} \wedge \gamma_{\mu_2} \dots \wedge \gamma_{\mu_p})^\dagger = \gamma_{\mu_p} \wedge \gamma_{\mu_{p-1}} \dots \wedge \gamma_{\mu_2} \wedge \gamma_{\mu_1} = (-1)^{p(p-1)/2} \gamma_{\mu_1} \wedge \gamma_{\mu_2} \dots \wedge \gamma_{\mu_p}$$

Hence only those terms that change sign ( under the reversal operation ) are permitted in the exponential defining  $R = \exp[\theta^A E_A]$ .

Another possibility is to *complexify* the C-space polyvector valued coordinates  $= Z = Z^A E_A = X^A E_A + iY^A E_A$  and the boosts/rotation parameters  $\theta$  allowing the unitarity condition  $\bar{U}^\dagger = U^{-1}$  to hold in the generalized Clifford unitary transformations  $Z' = UZU^\dagger$  associated with the complexified polyvector  $Z = Z^A E_A$  such that the interval

$$\langle d\bar{Z}^\dagger dZ \rangle_s = d\bar{\Omega}d\Omega + d\bar{z}^\mu dz_\mu + d\bar{z}^{\mu\nu} dz_{\mu\nu} + d\bar{z}^{\mu\nu\rho} dz_{\mu\nu\rho} + \dots$$

remains invariant ( upon setting the Planck scale  $\Lambda = 1$  ).

The unitary condition  $\bar{U}^\dagger = U^{-1}$  under the *combined* reversal and complex-conjugate operation will constrain the form of the complexified boosts/rotation parameters  $\theta^A$  appearing in the rotor :  $U = \exp[ \theta^A E_A ]$ . The theta parameters  $\theta^A$  are either purely real or purely imaginary depending if the reversal  $E_A^\dagger = \pm E_A$ , to ensure that an overall *change* of sign occurs in the terms  $\theta^A E_A$  inside the exponential defining  $U$  so that  $\bar{U}^\dagger = U^{-1}$  holds and the norm  $\langle \bar{Z}^\dagger Z \rangle_s$  remains invariant under the analog of unitary transformations in *complexified* C-spaces. These techniques are not very different from Penrose Twistor spaces. As far as we know a Clifford-Twistor space construction of C-spaces has not been performed so far.

Another alternative is to define the polyrotations by  $R = \exp( \Theta^{AB} [E_A, E_B] )$  where the commutator  $[E_A, E_B] = F_{ABC} E_C$  is the C-space analog of the  $i[\gamma_\mu, \gamma_\nu]$  commutator which is the generator of the Lorentz algebra, and the theta parameters  $\Theta^{AB}$  are the C-space analogs of the rotation/boots parameters  $\theta^{\mu\nu}$ . The diverse parameters  $\Theta^{AB}$  are purely real or purely imaginary depending whether the reversal  $[E_A, E_B]^\dagger = \pm [E_A, E_B]$  to ensure that  $R^\dagger = R^{-1}$  so that the scalar part  $\langle X^\dagger X \rangle_s$  remains invariant under the transformations  $X' = RXR^{-1}$ . This last alternative seems to be more physical because a poly-rotation should map the  $E_A$  direction into the  $E_B$  direction in C-spaces, hence the meaning of the generator  $[E_A, E_B]$  which extends the notion of the  $[\gamma_\mu, \gamma_\nu]$  Lorentz generator.

The above transformations are *active transformations* since the transformed Clifford number  $X'$  (polyvector) is different from the “original” Clifford number  $X$ . Considering the transformations of components we have

$$X' = X'^M E_M = L^M_N X^N E_M \quad (17)$$

If we compare (17) with (11) we find

$$L^M_N E_N = R E_N R^{-1} \quad (18)$$

from which it follows that

$$L^M_N = \langle E^M R E_N R^{-1} \rangle_0 \equiv E^M * (R E_N R^{-1}) = E^M * E'_N. \quad (19)$$

where we have labelled  $E'_N$  as new basis element since in the active interpretation one may perform either a change of the polyvector components or a change of the basis elements. The  $\langle \ \ \rangle_0$  means the scalar part of the expression and “\*” the scalar product. Eq(19) has been obtained after multiplying (18) from the left by  $E^J$ , taking into account that  $\langle E^J E_N \rangle_0 \equiv E^J * E_N = \delta^J_N$ , and renaming the index  $J$  into  $M$ .

### 3 Generalized Dynamics of Particles, Fields and Branes in C-space

An immediate application of this theory is that one may consider “strings” and “branes” in C-spaces as a unifying description of *all* branes of different dimensionality. As we have already indicated, since spinors are in left/right ideals of a Clifford algebra, a supersymmetry is then naturally incorporated into this approach as well. In particular, one can have world manifold and target space supersymmetry *simultaneously* [15]. We hope that the C-space “strings” and “branes” may lead us towards discovering the physical foundations of string and M-theory. For other alternatives to supersymmetry see the work by [50]. In particular,  $Z_3$  generalizations of supersymmetry based on ternary algebras and Clifford algebras have been proposed by Kerner [128] in what has been called Hypersymmetry.

#### 3.1 The Polyparticle Dynamics in C-space

We will now review the theory [15, 17] in which an extended object is modeled by the components  $\sigma, x^\mu, x^{\mu\nu}, \dots$  of the Clifford valued polyvector (2). By assumption the extended objects, as observed from Minkowski spacetime, can in general be localized not only along space-like, but also along time-like directions [15, 17]. In particular, they can be “instantonic” p-loops with either space-like or time-like orientation. Or they may be long, but finite, tube-like objects. The theory that we consider here goes beyond the ordinary relativity in Minkowski spacetime, therefore such localized objects in Minkowski spacetime pose no problems. They are postulated to satisfy the dynamical principle which is formulated in C-space. All conservation laws hold in C-space where we have infinitely long world “lines” or Clifford lines. In Minkowski spacetime  $M_4$  –which is a subspace of C-space– we observe the intersections of Clifford lines with  $M_4$ . And those intersections appear as localized extended objects, p-loops, described above.

Let the motion of such an extended object be determined by the action principle

$$I = \kappa \int d\tau (\dot{X}^\dagger * \dot{X})^{1/2} = \kappa \int d\tau (\dot{X}^A \dot{X}_A)^{1/2} \quad (20)$$

where  $\kappa$  is a constant, playing the role of “mass” in C-space, and  $\tau$  is an arbitrary parameter. The C-space velocities  $\dot{X}^A = dX^A/d\tau = (\dot{\sigma}, \dot{x}^\mu, \dot{x}^{\mu\nu}, \dots)$  are also called “hollographic” velocities.

The equation of motion resulting from (20) is

$$\frac{d}{d\tau} \left( \frac{\dot{X}^A}{\sqrt{\dot{X}^B \dot{X}_B}} \right) = 0 \quad (21)$$

Taking  $\dot{X}^B \dot{X}_B = \text{constant} \neq 0$  we have that  $\ddot{X}^A = 0$ , so that  $x^A(\tau)$  is a straight worldline in C-space. The components  $x^A$  then change linearly with the parameter  $\tau$ . This means that the extended object position  $x^\mu$ , effective area  $x^{\mu\nu}$ , 3-volume  $x^{\mu\nu\alpha}$ , 4-volume  $x^{\mu\nu\alpha\beta}$ , etc., they all change with time. That is, such object experiences a sort of generalized dilational motion [17].

We shall now review the procedure exposed in ref. [17] according to which in such a generalized dynamics an object may be accelerated to faster than light speeds as viewed from a 4-dimensional Minkowski space, which is a subspace of  $C$ -space. For a different explanation of superluminal propagation based on the modified nonlinear de Broglie dispersion relations see [68].

The canonical momentum belonging to the action (20) is

$$P_A = \frac{\kappa \dot{X}_A}{(\dot{X}^B \dot{X}_B)^{1/2}} \quad (22)$$

When the denominator in eq.(22) is zero the momentum becomes infinite. We shall now calculate the speed at which this happens. This will be the *maximum speed* that an object accelerating in  $C$ -space can reach. Although an initially slow object cannot accelerate beyond that speed limit, this does not automatically exclude the possibility that fast objects traveling at a speed above that limit may exist. Such objects are  $C$ -space analog of tachyons [31, 32]. All the well known objections against tachyons should be reconsidered for the case of  $C$ -space before we could say for sure that  $C$ -space tachyons do not exist as freely propagating objects. We will leave aside this interesting possibility, and assume as a working hypothesis that there is no tachyons in  $C$ -space.

Vanishing of  $\dot{X}^B \dot{X}_B$  is equivalent to vanishing of the  $C$ -space line element

$$dX^A dX_A = d\sigma^2 + \left(\frac{dx^0}{L}\right)^2 - \left(\frac{dx^1}{L}\right)^2 - \left(\frac{dx^{01}}{L^2}\right)^2 \dots + \left(\frac{dx^{12}}{L^2}\right)^2 - \left(\frac{dx^{123}}{L^3}\right)^2 - \left(\frac{dx^{0123}}{L^4}\right)^2 + \dots = 0 \quad (23)$$

where by “...” we mean the terms with the remaining components such as  $x^2$ ,  $x^{01}$ ,  $x^{23}$ , ...,  $x^{012}$ , etc.. The  $C$ -space line element is associated with a particular *choice* of  $C$ -space metric, namely  $G_{MN} = E_M^\dagger * E_N$ . If the basis  $E_M$ ,  $M = 1, 2, \dots, 2^D$  is generated by the flat space  $\gamma^\mu$  satisfying (3), then the  $C$ -space has the diagonal metric of eq. (23) with +, - signa. In general this is not necessarily so and the  $C$ -space metric is a more complicated expression. We take now dimension of spacetime being 4, so that  $x^{0123}$  is the highest grade coordinate. In eq. (23) we introduce a length parameter  $L$ . This is necessary, since  $x^0 = ct$  has dimension of length,  $x^{12}$  of length square,  $x^{123}$  of length to the third power, and  $x^{0123}$  of length to the fourth power. It is natural to assume that  $L$  is the *Planck length*, that is  $L = 1.6 \times 10^{-35}m$ .

Let us assume that the coordinate time  $t = x^0/c$  is the parameter with respect to which we define the speed  $V$  in  $C$ -space.

So we have

$$V^2 = - \left(L \frac{d\sigma}{dt}\right)^2 + \left(\frac{dx^1}{dt}\right)^2 + \left(\frac{dx^{01}}{L^2}\right)^2 \dots - \left(\frac{1}{L} \frac{dx^{12}}{dt}\right)^2 + \left(\frac{1}{L^2} \frac{dx^{123}}{dt}\right)^2 + \left(\frac{1}{L^3} \frac{dx^{0123}}{dt}\right)^2 - \dots \quad (24)$$

From eqs. (23),(24) we find that the maximum speed is the maximum speed is given by

$$V^2 = c^2 \quad (25)$$

First, we see that the maximum speed squared  $V^2$  contains not only the components of the 1-vector velocity  $dx^1/dt$ , as it is the case in the ordinary relativity, but also the multivector components such as  $dx^{12}/dt$ ,  $dx^{123}/dt$ , etc..

The following special cases when only certain components of the velocity in  $C$ -space are different from zero, are of particular interest:

(i) Maximum 1-vector speed

$$\frac{dx^1}{dt} = c = 3.0 \times 10^8 m/s$$

(ii) Maximum 3-vector speed

$$\begin{aligned} \frac{dx^{123}}{dt} &= L^2 c = 7.7 \times 10^{-62} m^3/s \\ \frac{d\sqrt[3]{x^{123}}}{dt} &= 4.3 \times 10^{-21} m/s \quad (\text{diameter speed}) \end{aligned}$$

(iii) Maximum 4-vector speed

$$\begin{aligned} \frac{dx^{0123}}{dt} &= L^3 c = 1.2 \times 10^{-96} m^4/s \\ \frac{d\sqrt[4]{x^{0123}}}{dt} &= 1.05 \times 10^{-24} m/s \quad (\text{diameter speed}) \end{aligned}$$

Above we have also calculated the corresponding diameter speeds for the illustration of how fast the object expands or contracts.

We see that the maximum multivector speeds are very small. The diameters of objects change very slowly. Therefore we normally do not observe the dilatational motion.

Because of the positive sign in front of the  $\sigma$  and  $x^{12}$ ,  $x^{012}$ , etc., terms in the quadratic form (23) there are no limits to corresponding 0-vector, 2-vector and 3-vector speeds. But if we calculate, for instance, the energy necessary to excite 2-vector motion we find that it is very high. Or equivalently, to the relatively modest energies (available at the surface of the Earth), the corresponding 2-vector speed is very small. This can be seen by calculating the energy

$$p^0 = \frac{\kappa c^2}{\sqrt{1 - \frac{V^2}{c^2}}} \quad (26)$$

(a) for the case of pure 1-vector motion by taking  $V = dx^1/dt$ , and

(b) for the case of pure 2-vector motion by taking  $V = dx^{12}/(Ldt)$ .

By equating the energies belonging to the cases (a) and (b) we have

$$p^0 = \frac{\kappa c^2}{\sqrt{1 - \left(\frac{1}{c} \frac{dx^1}{dt}\right)^2}} = \frac{\kappa c^2}{\sqrt{1 - \left(\frac{1}{Lc} \frac{dx^{12}}{dt}\right)^2}} \quad (27)$$

which gives

$$\frac{1}{c} \frac{dx^1}{dt} = \frac{1}{Lc} \frac{dx^{12}}{dt} = \sqrt{1 - \left(\frac{\kappa c^2}{p_0}\right)^2} \quad (28)$$

Thus to the energy of an object moving translationally at  $dx^1/dt = 1$  m/s, there corresponds the 2-vector speed  $dx^{12}/dt = L dx^1/dt = 1.6 \times 10^{-35}$  m<sup>2</sup>/s (diameter speed  $4 \times 10^{-18}$  m/s). This would be a typical 2-vector speed of a macroscopic object. For a microscopic object, such as the electron, which can be accelerated close to the speed of light, the corresponding 2-vector speed could be of the order of  $10^{-26}$  m<sup>2</sup>/s (diameter speed  $10^{-13}$  m/s). In the examples above we have provided rough estimations of possible 2-vector speeds. Exact calculations should treat concrete situations of collisions of two or more objects, assume that not only 1-vector, but also 2-vector, 3-vector and 4-vector motions are possible, and take into account the conservation of the polyvector momentum  $P_A$ .

*Maximum 1-vector speed, i.e., the usual speed, can exceed the speed of light when the holographic components such as  $d\sigma/dt$ ,  $dx^{12}/dt$ ,  $dx^{012}/dt$ , etc., are different from zero [17].* This can be immediately verified from eqs. (23),(24). The speed of light is no longer such a strict barrier as it appears in the ordinary theory of relativity in  $M_4$ . In  $C$ -space a particle has extra degrees of freedom, besides the translational degrees of freedom. The scalar,  $\sigma$ , the bivector,  $x^{12}$  (in general,  $x^{rs}$ ,  $r, s = 1, 2, 3$ ) and the three vector,  $x^{012}$  (in general,  $x^{0rs}$ ,  $r, s = 1, 2, 3$ ), contributions to the  $C$ -space quadratic form (23) have positive sign, which is just opposite to the contributions of other components, such as  $x^r$ ,  $x^{0r}$ ,  $x^{rst}$ ,  $x^{\mu\nu\rho\sigma}$ . Because some terms in the quadratic form have + and some – sign, the absolute value of the 3-velocity  $dx^r/dx^0$  can be greater than  $c$ .

It is known that when tachyons can induce a breakdown of causality. The simplest way to see why causality is violated when tachyons are used to exchange signals is by writing the temporal displacements  $\delta t = t^B - t^A$  between two events (in Minkowski space-time) in two different frames of reference:

$$(\delta t)' = (\delta t) \cosh(\xi) + \frac{\delta x}{c} \sinh(\xi) = (\delta t) \left[ \cosh(\xi) + \left(\frac{1}{c} \frac{\delta x}{\delta t}\right) \sinh(\xi) \right] = \quad (29)$$

$$(\delta t) \left[ \cosh(\xi) + (\beta_{tachyon}) \sinh(\xi) \right] \quad (30)$$

the boost parameter  $\xi$  is defined in terms of the velocity as  $\beta_{frame} = v_{frame}/c = \tanh(\xi)$ , where  $v_{frame}$  is the relative velocity ( in the  $x$ -direction ) of the two reference frames and can be written in terms of the Lorentz-boost rapidity parameter  $\xi$  by using hyperbolic functions. The Lorentz dilation factor is  $\cosh(\xi) = (1 - \beta_{frame}^2)^{-1/2}$ ; whereas  $\beta_{tachyon} = v_{tachyon}/c$  is the beta parameter associated with the tachyon velocity  $\delta x/\delta t$ . By emitting a tachyon along the *negative*  $x$ -direction one has  $\beta_{tachyon} < 0$  and such that its velocity exceeds the speed of light  $|\beta_{tachyon}| > 1$

A reversal in the sign of  $(\delta t)' < 0$  in the above boost transformations occurs when the tachyon velocity  $|\beta_{tachyon}| > 1$  and the relative velocity of the reference frames  $|\beta_{frame}| < 1$  obey the inequality condition :

$$(\delta t)' = (\delta t)[\cosh(\xi) - |\beta_{tachyon}|\sinh(\xi)] < 0 \Rightarrow 1 < \frac{1}{\tanh(\xi)} = \frac{1}{\beta_{frame}} < |\beta_{tachyon}|. \quad (31)$$

thereby resulting in a causality violation in the primed reference frame since the effect ( event  $B$  ) occurs *before* the cause ( event  $A$  ) in the *primed* reference frame.

In the case of subluminal propagation  $|\beta_{particle}| < 1$  there is no causality violation since one would have :

$$(\delta t)' = (\delta t)[\cosh(\xi) - |\beta_{particle}|\sinh(\xi)] > 0 \quad (32)$$

due to the hyperbolic trigonometric relation :

$$\cosh^2(\xi) - \sinh^2(\xi) = 1 \Rightarrow \cosh(\xi) - \sinh(\xi) \geq 0 \quad (33)$$

In the theory considered here, there are no tachyons in  $C$ -space, because physical signals in  $C$ -space are constrained to live *inside* the  $C$ -space-light cone, defined by eq. (23). However, certain worldlines in  $C$ -space, when projected onto the subspace  $M_4$ , can appear as worldlines of ordinary tachyons outside the lightcone in  $M_4$ . The physical analog of photons in  $C$ -space corresponds to tensionless  $p$ -loops, i.e., *tensionless* closed branes, since the analog of mass  $m$  in  $C$ -space is the maximal  $p$ -loop tension. By ‘maximal  $p$ -loop’ we mean the loop with the maximum value of  $p$  associated with the hierarchy of  $p$ -loops (closed  $p$ -branes):  $p = 0, 1, 2, \dots$  living in the embedding target spacetime. One must not confuse the Stueckelberg parameter  $\sigma$  with the  $C$ -space Proper-time  $\Sigma$  (eq.(5)); so one could have a world line in  $C$ -space such that

$$d\Sigma = 0 \leftrightarrow C\text{-space photon} \leftrightarrow \begin{array}{l} \text{tensionless branes with a monotonically increasing} \\ \text{Stueckelberg parameter } \sigma \end{array}$$

In  $C$ -space the dynamics refers to a larger space. Minkowski space is just a subspace of  $C$ -space. "Worldlines" now live in  $C$ -space that can be projected onto the Minkowski subspace  $M_4$ . Concerning tachyons and causality within the framework of the  $C$ -space relativity, the authors of this review propose two different explanations, described below.

According to one author (C.C) one has to take into account the fact that one is enlarging the ordinary Lorentz group to a larger group of  $C$ -space Lorentz transformations which involve poly-rotations and generalizations of boosts transformations. In particular, the  $C$ -space generalization of the ordinary boost transformations associated with the boost rapidity parameter  $\xi$  such that  $\tanh(\xi) = \beta_{frame}$  will involve now the family of  $C$ -space boost rapidity parameters  $\theta^{t^1}, \theta^{t^{12}}, \theta^{t^{123}}, \dots, \theta^{t^{123\dots}}, \dots$  since boosts are just ( poly ) rotations along directions involving the *time* coordinate. Thus, one is replacing the ordinary boost transformations in Minkowski spacetime for the more general  $C$ -space boost transformations as we go from one frame of reference to another frame of reference.

Due to the linkage among the  $C$ -space coordinates (poly-dimensional covariance) when we envision an ordinary boost along the  $x^1$ - direction, we must not forget that it is also interconnected to the area-booster in the  $x^{12}$ -direction as well, and, which in turn, is also



linked to the  $x^2$  direction. Because the latter direction is *transverse* to the original tachyonic  $x^1$ -motion, the latter  $x^2$ -boosts won't affect things and we may concentrate on the area-boosts along the  $x^{12}$  direction involving the  $\theta^{t12}$  parameter that will appear in the C-space boosts and which contribute to a crucial extra term in the transformations such that no sign-change in  $\delta t'$  will occur.

More precisely, let us set *all* the values of the theta parameters to zero *except* the parameters  $\theta^{t1}$  and  $\theta^{t12}$  related to the ordinary boosts in the  $x^1$  direction and area-boosts in the  $x^{12}$  directions of C-space. This requires, for example, that one has at least one spatial-area component, and one temporal coordinate, which implies that the dimensions must be at least  $D = 2 + 1 = 3$ . Thus, we have in this case :

$$X' = R X R^{-1} = e^{\theta^{t1}\gamma_t \wedge \gamma_1 + \theta^{t12}\gamma_t \wedge \gamma_1 \wedge \gamma_2} X^M E_M e^{-\theta^{t1}\gamma_t \wedge \gamma_1 - \theta^{t12}\gamma_t \wedge \gamma_1 \wedge \gamma_2} \Rightarrow X'^N = L_M^N X^M. \quad (34)$$

where as we shown previously  $L_M^N = \langle E^N R E_M R^{-1} \rangle_0$ . When one concentrates on the transformations of the time coordinate, we have now that the C-space boosts do *not* coincide with ordinary boosts in the  $x^1$  direction :

$$t' = L_M^t X^M = \langle E^t R E_M R^{-1} \rangle_0 X^M \neq (L_t^t)t + (L_1^t)x^1. \quad (35)$$

because of the extra non-vanishing  $\theta$  parameter  $\theta^{t12}$ .

This is because the rotor  $R$  includes the extra generator  $\theta^{t12}\gamma_t \wedge \gamma_1 \wedge \gamma_2$  which will bring extra terms into the transformations ; i.e. it will rotate the  $E_{[12]}$  bivector- basis , that couples to the holographic coordinates  $x^{12}$ , into the  $E_t$  direction which is being contracted with the  $E^t$  element in the definition of  $L_M^t$ . There are extra terms in the C-space boosts because the poly-particle dynamics is taking place in C-space and all coordinates  $X^M$  which contain the  $t, x^1, x^{12}$  directions will contribute to the C-space boosts in  $D = 3$ , since one is projecting down the dynamics from C-space onto the  $(t, x^1)$  plane when one studies the motion of the tachyon in  $M_4$ .

Concluding, in the case when one sets all the *theta* parameters to zero, except the  $\theta^{t1}$  and  $\theta^{t12}$ , the  $X' = R X^M E_M R^{-1}$  transformations will be :

$$(\delta t)' = L_M^t(\theta^{t1}; \theta^{t12})(\delta X^M) \neq L_t^t(\delta t) + L_1^t(\delta x^1). \quad (36)$$

due to the presence of the *extra* term  $L_{12}^t(\delta X^{12})$  in the transformations. In the more general case, when there are more non-vanishing *theta* parameters , the indices  $M$  of the  $X^M$  coordinates must be *restricted* to those directions in C-space which involve the  $t, x^1, x^{12}, x^{123}$ ..... directions as required by the C-space poly-particle dynamics. The generalized C-space boosts involve now the ordinary tachyon velocity component of the poly-particle as well as the generalized holographic areas, volumes, hyper-volumes...velocities  $V^M = (\delta X^M / \delta t)$  associated with the poly-vector components of the Clifford-valued C-space velocity.

Hence, at the expense of *enlarging* the ordinary Lorentz boosts to the C-space Lorentz boosts, and the degrees of freedom of a point particle into an extended poly-particle by including the holographic coordinates, in C-space one can still have ordinary point-particle tachyons without changing the sign of  $\delta t$ , and without violating causality, due to

the presence of the *extra* terms in the C-space boosts transformations which ensure us that the sign of  $\delta t > 0$  is maintained as we go from one frame of reference to another one. Naturally, if one were to *freeze* all the  $\theta$  parameters to zero except one  $\theta^{t1}$  one would end up with the standard Lorentz boosts along the  $x^1$  -direction and a violation of causality would occur for tachyons as a result of the sign-change in  $\delta t'$  .

In future work we shall analyze in more detail if the condition  $\delta t' = L_M^t(\delta X^M) > 0$  is satisfied for *any* physical values of the *theta* C-space boosts parameters and for *any* physical values of the holographic velocities consistent with the condition that the C-space velocity  $V_M V^M \geq 0$  . What one cannot have is a C-space tachyon; i.e. the physical signals in C-space must be constrained to live *inside* the C-space light-cone. The analog of " photons " in C-space are *tensionless* branes . The corresponding analog of C-space tachyons involve branes with imaginary tensions, not unlike ordinary tachyons  $m^2 < 0$  of imaginary mass.

To sum up : Relativity in C-space demands *enlarging* the ordinary Lorentz group ( boosts ) to a larger symmetry group of C-space Lorentz group and enlarging the degrees of freedom by including Clifford-valued coordinates  $X = X^M E_M$ . This is the only way one can have a point-particle tachyonic speed in a Minkowski subspace without violating causality in C-space. Ordinary Lorentz boosts are incompatible with tachyons if one wishes to preserve causality . In C-space one requires to have, at least, two theta parameters  $\theta^{t1}$  and  $\theta^{t12}$  with the inclusion, at least, of the  $t, x^1, x^{12}$  coordinates in a C-space boost, to be able to enforce the condition  $\delta t' > 0$  under ( combined ) boosts along the  $x^1$  direction accompanied by an *area*-boost along the  $x^{12}$  direction of C-space . It is beyond the scope of this review to analyze all the further details of the full-fledged C-boosts transformations in order to check that the condition  $\delta t' > 0$  is obeyed for *any* physical values of the *theta* parameters and holographic velocities.

According to the other author (M.P.), the problem of causality could be explained as follows. In the usual theory of relativity the existence of tachyons is problematic because one can arrange for situations such that tachyons are sent into the past. A tachyon  $T_1$  is emitted from an apparatus worldline  $\mathcal{C}$  at  $x_1^0$  and a second tachyon  $T_2$  can arrive to the same worldline  $\mathcal{C}$  at an earlier time  $x'^0 < x_1^0$  and trigger destruction of the apparatus. The spacetime event  $E'$  at which the apparatus is destroyed coincides with the event  $E$  at which the apparatus by initial assumption kept on functioning normally and later emitted  $T_1$ . So there is a paradox from the ordinary ( constrained ) relativistic particle dynamics.

There is no paradox if one invokes the unconstrained Stueckelberg description of superluminal propagation in  $M_4$ . It can be described as follows. A C-space worldline can be described in terms of five functions  $x^\mu(\tau)$ ,  $\sigma(\tau)$  (all other C-space coordinates being kept constant). In C-space we have the *constrained action* (20), whilst in Minkowski space we have a reduced, *unconstrained* action. A reduction of variables can be done by choosing a gauge in which  $\sigma(\tau) = \tau$ . It was shown in ref.[16, 15, 17] that the latter unconstrained action is equivalent to the well known Stueckelberg action [33, 34]. In other words, the Stueckelberg relativistic dynamics is embedded in C-space. In Stueckelberg theory all four spacetime coordinates  $x^\mu$  are independent dynamical degrees of freedom that evolve in terms of an extra parameter  $\sigma$  which is invariant under Lorentz transformations in  $M_4$ .

From the C-space point of view, the evolution parameter  $\sigma$  is just one of the C-space

coordinates  $X^M$ . By assumption,  $\sigma$  is monotonically increasing along particles' worldlines. Certain  $C$ -space worldlines may appear tachyonic from the point of view of  $M_4$ . If we now repeat the above experiment with the emission of the first and absorption of the second tachyon we find out that the second tachyon  $T_2$  cannot reach the apparatus worldline earlier than it was emitted from. Namely,  $T_2$  can arrive at a  $C$ -space event  $E'$  with  $x'^0 < x_1^0$ , but the latter event does not coincide with the event  $E$  on the apparatus worldline, since although having the same coordinates  $x'^\mu = x^\mu$ , the events  $E$  and  $E'$  have different extra coordinates  $\sigma' \neq \sigma$ . In other words,  $E$  and  $E'$  are different points in  $C$ -space. Therefore  $T_2$  cannot destroy the apparatus and there is no paradox.

If nature indeed obeys the dynamics in Clifford space, then a particle, as observed from the 4-dimensional Minkowski space, can be accelerated beyond the speed of light [17], provided that its extra degrees of freedom  $x^{\mu\nu}$ ,  $x^{\mu\nu\alpha}$ , ..., are changing simultaneously with the ordinary position  $x^\mu$ . But such a particle, although moving faster than light in the subspace  $M_4$ , is moving slower than light in  $C$ -space, since its speed  $V$ , defined in eq.(24), is smaller than  $c$ . *In this respect, our particle is not tachyon at all!* In  $C$ -space we thus retain all the nice features of relativity, but in the subspace  $M_4$  we have, as a particular case, the unconstrained Stueckelberg theory in which faster-than-light propagation is not paradoxical and is consistent with the quantum field theory as well [15]. This is so, because the unconstrained Stueckelberg theory is quite different from the ordinary (constrained) theory of relativity in  $M_4$ , and faster than light motion in the former theory is of totally different nature from the faster than light motion in the latter theory. The tachyonic "world lines" in  $M_4$  are just projections of trajectories in  $C$ -space onto Minkowski space, however, the true world lines of  $M_4$  must be interpreted always as being embedded onto a larger  $C$ -space, such that they cannot take part in the paradoxical arrangement in which future could influence the past. The well known objections against tachyons are not valid for our particle which moves according to the relativity in  $C$ -space.

We have described how one can obtain faster than light motion in  $M_4$  from the theory of relativity in  $C$ -space. There are other possible ways to achieve superluminal propagation. One such approach is described in refs. [84]

**An alternative procedure** In ref. [9] an alternative factorization of the  $C$ -space line element has been undertaken. Starting from the line element  $d\Sigma$  of eq. (5), instead of factoring out the  $(dx^0)^2$  element, one may factor out the  $(d\Omega)^2 \equiv L^{2D}d\sigma^2$  element, giving rise to the generalized "holographic" velocities measured w.r.t the  $\Omega$  parameter, for example the areal-time parameter in the Eguchi-Schild formulation of string dynamics [126], [37], [24], instead of the  $x^0$  parameter (coordinate clock). One then obtains

$$d\Sigma^2 = d\Omega^2 \left[ 1 + L^{2D-2} \frac{dx_\mu}{d\Omega} \frac{dx^\mu}{d\Omega} + L^{2D-4} \frac{dx_{\mu\nu}}{d\Omega} \frac{dx^{\mu\nu}}{d\Omega} + \dots + |\gamma|^2 \left( \frac{d\tilde{\sigma}}{d\Omega} \right)^2 \right] \quad (37)$$

The idea of ref. [9] was to restrict the line element (37) to the non tachyonic values which imposes an upper limit on the holographic velocities. The motivation was to find a lower bound of length scale. This upper holographic-velocity bound does not necessarily translate into a lower bound on the values of lengths, areas, volumes....without the introduction

of quantum mechanical considerations. One possibility could be that the upper limiting speed of light and the upper bound of the momentum  $m_p c$  of a Planck-mass elementary particle (the so-called *Planckton* in the literature) generalizes now to an upper-bound in the  $p$ -loop holographic velocities and the  $p$ -loop holographic momenta associated with elementary closed  $p$ -branes whose tensions are given by powers of the Planck mass. And the latter upper bounds on the holographic  $p$ -loop momenta implies a lower-bound on the holographic areas, volumes,..., resulting from the string/brane uncertainty relations [11], [10],[19]. Thus, Quantum Mechanics is required to implement the postulated principle of minimal lengths, areas, volumes...and which cannot be derived from the classical geometry alone. The emergence of minimal Planck areas occurs also in the Loop Quantum Gravity program [111] where the expectation values of the Area operator are given by multiples of Planck area.

Recently in [134] an isomorphism between Yang's Noncommutative space-time algebra (involving *two* length scales) [136] and the *holographic area coordinates* algebra of C-spaces (Clifford spaces) was constructed via an  $AdS_5$  space-time which is instrumental in explaining the origins of an extra (infrared) scale  $R$  in conjunction to the (ultraviolet) Planck scale  $\lambda$  characteristic of C-spaces. Yang's Noncommutative space-time algebra allowed Tanaka [137] to explain the origins behind the *discrete* nature of the spectrum for the *spatial* coordinates and *spatial* momenta which yields a *minimum* length-scale  $\lambda$  (ultraviolet cutoff) and a minimum momentum  $p = \hbar/R$  (maximal length  $R$ , infrared cutoff). In particular, the norm-squared  $\mathbf{A}^2$  of the holographic Area operator  $X_{AB}X^{AB}$  has a correspondence with the quadratic Casimir operator  $\Sigma_{AB}\Sigma^{AB}$  of the conformal algebra  $SO(4,2)$  ( $SO(5,1)$  in the Euclideanized  $AdS_5$  case). This holographic area-Casimir relationship does not differ much from the area-spin relation in Loop Quantum Gravity  $\mathbf{A}^2 \sim \lambda^4 \sum j_i(j_i + 1)$  in terms of the  $SU(2)$  Casimir  $J^2$  with eigenvalues  $j(j + 1)$  and where the sum is taken over the spin network sites.

### 3.2 A Unified Theory of all p-Branes in C-Spaces

The generalization to C-spaces of string and p-brane actions as embeddings of world-manifolds onto target spacetime backgrounds involves the embeddings of polyvector-valued world-manifolds (of dimensions  $2^d$ ) onto polyvector-valued target spaces (of dimensions  $2^D$ ), given by the Clifford-valued maps  $X = X(\Sigma)$  (see [15]). These are maps from the Clifford-valued world-manifold, parametrized by the polyvector-valued variables  $\Sigma$ , onto the Clifford-valued target space parametrized by the polyvector-valued coordinates  $X$ . Physically one envisions these maps as taking an  $n$ -dimensional simplicial cell ( $n$ -loop) of the world-manifold onto an  $m$ -dimensional simplicial cell ( $m$ -loop) of the target C-space manifold ; i.e. maps from  $n$ -dim objects onto  $m$ -dim objects generalizing the old maps of taking points onto points. One is basically dealing with a dimension-category of objects. The size of the simplicial cells ( $p$ -loops), upon quantization of a generalized harmonic oscillator, for example, are given by multiples of the Planck scale, in area, volume, hypervolume units or Clifford-bits.

In compact multi-index notation  $X = X^M \Gamma_M$  one denotes for each one of the compo-

nents of the target space polyvector  $X$ :

$$X^M \equiv X^{\mu_1 \mu_2 \dots \mu_r}, \quad \mu_1 < \mu_2 < \dots < \mu_r. \quad (38)$$

and for the world-manifold polyvector  $\Sigma = \Sigma^A E_A$ :

$$\Sigma^A \equiv \xi^{a_1 a_2 \dots a_s}, \quad a_1 < a_2 < \dots < a_s. \quad (39)$$

where  $\Gamma_M = (\underline{1}, \gamma_\mu, \gamma_{\mu\nu}, \dots)$  and  $E_A = (\underline{1}, e_a, e_{ab}, \dots)$  form the basis of the target manifold and world manifold Clifford algebra, respectively. It is very important to order the indices within each multi-index  $M$  and  $A$  as shown above. The above Clifford-valued coordinates  $X^M, \Sigma^A$  correspond to antisymmetric tensors of ranks  $r, s$  in the target spacetime background and in the world-manifold, respectively.

There are many different ways to construct C-space brane actions which are on-shell equivalent to the analogs of the Dirac-Nambu-Goto action for extended objects and that are given by the world-volume spanned by the branes in their motion through the target spacetime background.

One of these actions is the Polyakov-Howe-Tucker action:

$$I = \frac{T}{2} \int [D\Sigma] \sqrt{|H|} [H^{AB} \partial_A X^M \partial_B X^N G_{MN} + (2 - 2^d)]. \quad (40)$$

with the  $2^d$ -dim world-manifold measure:

$$[D\Sigma] = (d\xi)(d\xi^a)(d\xi^{a_1 a_2})(d\xi^{a_1 a_2 a_3}) \dots \quad (41)$$

Upon the algebraic elimination of the auxiliary world-manifold metric  $H^{AB}$  from the action (40), via the equations of motion, yields for its on-shell solution the pullback of the target C-space metric onto the C-space world-manifold:

$$H_{AB}(\text{on-shell}) = G_{AB} = \partial_A X^M \partial_B X^N G_{MN} \quad (42)$$

upon inserting back the on-shell solutions (42) into (40) gives the Dirac-Nambu-Goto action for the C-space branes directly in terms of the C-space determinant, or measure, of the induced C-space world-manifold metric  $G_{AB}$ , as a result of the embedding:

$$I = T \int [D\Sigma] \sqrt{\text{Det}(\partial_A X^M \partial_B X^N G_{MN})}. \quad (43)$$

However in C-space, the Polyakov-Howe-Tucker action admits an even further generalization that is comprised of two terms  $S_1 + S_2$ . The first term is [15] :

$$S_1 = \int [D\Sigma] |E| E^A E^B \partial_A X^M \partial_B X^N \Gamma_M \Gamma_N. \quad (44)$$

Notice that this is a generalized action which is written in terms of the C-space coordinates  $X^M(\Sigma)$  and the C-space analog of the target-spacetime vielbein/frame one-forms  $e^m = e^m{}_\mu dx^\mu$  given by the  $\Gamma^M$  variables. The auxiliary world-manifold vielbein variables  $e^a$ , are given now by the Clifford-valued frame  $E^A$  variables.

In the conventional Polyakov-Howe-Tucker action, the auxiliary world-manifold metric  $h^{ab}$  associated with the standard p-brane actions is given by the usual scalar product of the frame vectors  $e^a \cdot e^b = e_\mu^a e_\nu^b g^{\mu\nu} = h^{ab}$ . Hence, the C-space world-manifold metric  $H^{AB}$  appearing in (42) is given by scalar product  $\langle (E^A)^\dagger E^B \rangle_0 = H^{AB}$ , where  $(E^A)^\dagger$  denotes the reversal operation of  $E^A$  which requires reversing the ordering of the vectors present in the Clifford aggregate  $E^A$ .

Notice, however, that the form of the action (44) is far more general than the action in (40). In particular, the  $S_1$  itself can be decomposed further into two additional pieces by rewriting the Clifford product of two basis elements into a symmetric plus an antisymmetric piece, respectively:

$$E^A E^B = \frac{1}{2}\{E^A, E^B\} + \frac{1}{2}[E^A, E^B]. \quad (45)$$

$$\Gamma_M \Gamma_N = \frac{1}{2}\{\Gamma_M, \Gamma_N\} + \frac{1}{2}[\Gamma_M, \Gamma_N]. \quad (46)$$

In this fashion, the  $S_1$  component has *two* kinds of terms. The first term containing the symmetric combination is just the analog of the standard non-linear sigma model action, and the second term is a Wess-Zumino-like term, containing the antisymmetric combination. To extract the non-linear sigma model part of the generalized action above, we may simply take the scalar product of the vielbein-variables as follows:

$$(S_1)_{sigma} = \frac{T}{2} \int [D\Sigma] |E| \langle (E^A \partial_A X^M \Gamma_M)^\dagger (E^B \partial_B X^N \Gamma_N) \rangle_0. \quad (47)$$

where once again we have made use of the reversal operation (the analog of the hermitian adjoint) before contracting multi-indices. In this fashion we recover again the Clifford-scalar valued action given by [15].

Actions like the ones presented here in terms of derivatives with respect to quantities with multi-indices can be mapped to actions involving *higher* derivatives, in the same fashion that the C-space scalar curvature, the analog of the Einstein-Hilbert action, could be recast as a higher derivative gravity with torsion (reviewed in sec. 4). Higher derivatives actions are also related to theories of Higher spin fields [117] and  $W$ -geometry,  $W$ -algebras [116], [122]. For the role of Clifford algebras to higher spin theories see [51].

The  $S_2$  (scalar) component of the C-space brane action is the usual cosmological constant term given by the C-space determinant  $|E| = \det(H^{AB})$  based on the scalar part of the geometric product  $\langle (E^A)^\dagger E^B \rangle_0 = H^{AB}$

$$S_2 = \frac{T}{2} \int [D\Sigma] |E| (2 - 2^d) \quad (48)$$

where the C-space determinant  $|E| = \sqrt{|\det(H^{AB})|}$  of the  $2^d \times 2^d$  generalized world-manifold metric  $H^{AB}$  is given by:

$$\det(H^{AB}) = \frac{1}{(2^d)!} \epsilon_{A_1 A_2 \dots A_{2^d}} \epsilon_{B_1 B_2 \dots B_{2^d}} H^{A_1 B_1} H^{A_2 B_2} \dots H^{A_{2^d} B_{2^d}}. \quad (49)$$

The  $\epsilon_{A_1 A_2 \dots A_{2d}}$  is the totally antisymmetric tensor density in  $C$ -space.

There are many different forms of  $p$ -brane actions, with and without a cosmological constant [123], and based on a new integration measure by recurring to auxiliary scalar fields [115], that one could have used to construct their  $C$ -space generalizations. Since all of them are on-shell equivalent to the Dirac-Nambu-Goto  $p$ -brane actions, we decided to focus solely on those actions having the Polyakov-Howe-Tucker form.

## 4 Generalized Gravitational Theories in Curved C-spaces: Higher Derivative Gravity and Torsion from the Geometry of C-Space

### 4.1 Ordinary space

#### 4.1.1 Clifford algebra based geometric calculus in curved space(time)

Clifford algebra is a very useful tool for description of geometry, especially of curved space  $V_n$ . Let us first review how it works in curved space(time). Later we will discuss a generalization to curved Clifford space [20].

We would like to make those techniques accessible to a wide audience of physicists who are not so familiar with the rigorous underlying mathematics, and demonstrate how Clifford algebra can be straightforwardly employed in the theory of gravity and its generalization. So we will leave aside the sophisticated mathematical approach, and rather follow as simple line of thought as possible, a praxis that is normally pursued by physicists. For instance, physicists in their works on general relativity employ a mathematical formulation and notation which is much simpler from that of purely mathematical or mathamatically oriented works. For rigorous mathematical treatment the reader is advised to study, refs. [1, 76, 77, 78, 79].

Let the vector fields  $\gamma_\mu$ ,  $\mu = 1, 2, \dots, n$  be a coordinate basis in  $V_n$  satisfying the Clifford algebra relation

$$\gamma_\mu \cdot \gamma_\nu \equiv \frac{1}{2}(\gamma_\mu \gamma_\nu + \gamma_\nu \gamma_\mu) = g_{\mu\nu} \quad (50)$$

where  $g_{\mu\nu}$  is the metric of  $V_n$ . In curved space  $\gamma_\mu$  and  $g_{\mu\nu}$  cannot be constant but necessarily depend on position  $x^\mu$ . An arbitrary vector is a linear superposition [1]

$$a = a^\mu \gamma_\mu \quad (51)$$

where the components  $a^\mu$  are *scalars* from the geometric point of view, whilst  $\gamma_\mu$  are *vectors*.

Besides the basis  $\{\gamma_\mu\}$  we can introduce the reciprocal basis<sup>2</sup>  $\{\gamma^\mu\}$  satisfying

$$\gamma^\mu \cdot \gamma^\nu \equiv \frac{1}{2}(\gamma^\mu \gamma^\nu + \gamma^\nu \gamma^\mu) = g^{\mu\nu} \quad (52)$$

---

<sup>2</sup>In Appendix A of the Hestenes book [1] the frame  $\{\gamma^\mu\}$  is called *dual* frame because the duality operation is used in constructing it.

where  $g^{\mu\nu}$  is the covariant metric tensor such that  $g^{\mu\alpha}g_{\alpha\nu} = \delta^\mu_\nu$ ,  $\gamma^\mu\gamma_\nu + \gamma_\nu\gamma^\mu = 2\delta^\mu_\nu$  and  $\gamma^\mu = g^{\mu\nu}\gamma_\nu$ .

Following ref.[1] (see also [15]) we consider the *vector derivative* or *gradient* defined according to

$$\partial \equiv \gamma^\mu \partial_\mu \quad (53)$$

where  $\partial_\mu$  is an operator whose action depends on the quantity it acts on [26].

Applying the vector derivative  $\partial$  on a *scalar* field  $\phi$  we have

$$\partial\phi = \gamma^\mu \partial_\mu \phi \quad (54)$$

where  $\partial_\mu \phi \equiv (\partial/\partial x^\mu)\phi$  coincides with the partial derivative of  $\phi$ .

But if we apply it on a *vector* field  $a$  we have

$$\partial a = \gamma^\mu \partial_\mu (a^\nu \gamma_\nu) = \gamma^\mu (\partial_\mu a^\nu \gamma_\nu + a^\nu \partial_\mu \gamma_\nu) \quad (55)$$

In general  $\gamma_\nu$  is not constant; it satisfies the relation [1, 15]

$$\partial_\mu \gamma_\nu = \Gamma_{\mu\nu}^\alpha \gamma_\alpha \quad (56)$$

where  $\Gamma_{\mu\nu}^\alpha$  is the *connection*. Similarly, for  $\gamma^\nu = g^{\nu\alpha}\gamma_\alpha$  we have

$$\partial_\mu \gamma^\nu = -\Gamma_{\mu\alpha}^\nu \gamma^\alpha \quad (57)$$

The *non commuting* operator  $\partial_\mu$  so defined determines *the parallel transport* of a basis vector  $\gamma^\nu$ . Instead of the symbol  $\partial_\mu$  Hestenes uses  $\square_\mu$ , whilst Wheeler et. al. [36] use  $\nabla_\mu$  and call it ‘‘covariant derivative’’. In modern, mathematically oriented literature more explicit notation such as  $D_{\gamma_\mu}$  or  $\nabla_{\gamma_\mu}$  is used. However, such a notation, although mathematically very relevant, would not be very practical in long computations. We find it very convenient to keep the symbol  $\partial_\mu$  for components of the geometric operator  $\partial = \gamma^\mu \partial_\mu$ . When acting on a scalar field the derivative  $\partial_\mu$  happens to be commuting and thus behaves as the ordinary partial derivative. When acting on a vector field,  $\partial_\mu$  is a *non commuting operator*. In this respect, there can be no confusion with partial derivative, because the latter normally acts on *scalar fields*, and in such a case partial derivative and  $\partial_\mu$  are one and the same thing. However, when acting on a vector field, the derivative  $\partial_\mu$  is non commuting. Our operator  $\partial_\mu$  when acting on  $\gamma_\mu$  or  $\gamma^\mu$  should be distinguished from the ordinary—*commuting*—partial derivative, let be denoted  $\gamma^\nu_{,\mu}$ , usually used in the literature on the Dirac equation in curved spacetime. The latter derivative is not used in the present paper, so there should be no confusion.

Using (56), eq.(55) becomes

$$\partial a = \gamma^\mu \gamma_\nu (\partial_\mu a^\nu + \Gamma_{\mu\alpha}^\nu a^\alpha) \equiv \gamma^\mu \gamma_\nu D_\mu a^\nu = \gamma^\mu \gamma^\nu D_\mu a_\nu \quad (58)$$

where  $D_\mu$  is the covariant derivative of tensor analysis..

Decomposing the Clifford product  $\gamma^\mu \gamma^\nu$  into its symmetric and antisymmetric part [1]

$$\gamma^\mu \gamma^\nu = \gamma^\mu \cdot \gamma^\nu + \gamma^\mu \wedge \gamma^\nu \quad (59)$$



where

$$\gamma^\mu \cdot \gamma^\nu \equiv \frac{1}{2}(\gamma^\mu \gamma^\nu + \gamma^\nu \gamma^\mu) = g^{\mu\nu} \quad (60)$$

is the *inner product* and

$$\gamma^\mu \wedge \gamma^\nu \equiv \frac{1}{2}(\gamma^\mu \gamma^\nu - \gamma^\nu \gamma^\mu) \quad (61)$$

the *outer product*, we can write eq.(58) as

$$\partial a = g^{\mu\nu} D_\mu a_\nu + \gamma^\mu \wedge \gamma^\nu D_\mu a_\nu = D_\mu a^\mu + \frac{1}{2} \gamma^\mu \wedge \gamma^\nu (D_\mu a_\nu - D_\nu a_\mu) \quad (62)$$

Without employing the expansion in terms of  $\gamma_\mu$  we have simply

$$\partial a = \partial \cdot a + \partial \wedge a \quad (63)$$

Acting twice on a vector by the operator  $\partial$  we have<sup>3</sup>

$$\begin{aligned} \partial \partial a &= \gamma^\mu \partial_\mu (\gamma^\nu \partial_\nu) (a^\alpha \gamma_\alpha) = \gamma^\mu \gamma^\nu \gamma_\alpha D_\mu D_\nu a^\alpha \\ &= \gamma_\alpha D_\mu D^\mu a^\alpha + \frac{1}{2} (\gamma^\mu \wedge \gamma^\nu) \gamma_\alpha [D_\mu, D_\nu] a^\alpha \\ &= \gamma_\alpha D_\mu D^\mu a^\alpha + \gamma^\mu (R_{\mu\rho} a^\rho + K_{\mu\alpha}{}^\rho D_\rho a^\alpha) \\ &\quad + \frac{1}{2} (\gamma^\mu \wedge \gamma^\nu \wedge \gamma_\alpha) (R_{\mu\nu\rho}{}^\alpha a^\rho + K_{\mu\nu}{}^\rho D_\rho a^\alpha) \end{aligned} \quad (64)$$

We have used

$$[D_\mu, D_\nu] a^\alpha = R_{\mu\nu\rho}{}^\alpha a^\rho + K_{\mu\nu}{}^\rho D_\rho a^\alpha \quad (65)$$

where

$$K_{\mu\nu}{}^\rho = \Gamma_{\mu\nu}^\rho - \Gamma_{\nu\mu}^\rho \quad (66)$$

is *torsion* and  $R_{\mu\nu\rho}{}^\alpha$  the *curvature tensor*. Using eq.(56) we find

$$[\partial_\alpha, \partial_\beta] \gamma_\mu = R_{\alpha\beta\mu}{}^\nu \gamma_\nu \quad (67)$$

from which we have

$$R_{\alpha\beta\mu}{}^\nu = ([[\partial_\alpha, \partial_\beta] \gamma_\mu] \cdot \gamma^\nu) \quad (68)$$

Thus in general the commutator of derivatives  $\partial_\mu$  acting on a vector does not give zero, but is given by the curvature tensor.

In general, for an  $r$ -vector  $A = a^{\alpha_1 \dots \alpha_r} \gamma_{\alpha_1} \gamma_{\alpha_2} \dots \gamma_{\alpha_r}$  we have

$$\begin{aligned} \partial \partial \dots \partial A &= (\gamma^{\mu_1} \partial_{\mu_1}) (\gamma^{\mu_2} \partial_{\mu_2}) \dots (\gamma^{\mu_k} \partial_{\mu_k}) (a^{\alpha_1 \dots \alpha_r} \gamma_{\alpha_1} \gamma_{\alpha_2} \dots \gamma_{\alpha_r}) \\ &= \gamma^{\mu_1} \gamma^{\mu_2} \dots \gamma^{\mu_k} \gamma_{\alpha_1} \gamma_{\alpha_2} \dots \gamma_{\alpha_r} D_{\mu_1} D_{\mu_2} \dots D_{\mu_k} a^{\alpha_1 \dots \alpha_r} \end{aligned} \quad (69)$$

---

<sup>3</sup>We use  $(a \wedge b)c = (a \wedge b) \cdot c + a \wedge b \wedge c$  [1] and  $(a \wedge b) \cdot c = (b \cdot c)a - (a \cdot c)b$ .

### 4.1.2 Clifford algebra based geometric calculus and resolution of the ordering ambiguity for the product of momentum operators

Clifford algebra is a very useful tool for description of geometry of curved space. Moreover, as shown in ref.[26] it provides a resolution of the long standing problem of the ordering ambiguity of quantum mechanics in curved space. Namely, eq.(53) for the vector derivative suggests that the momentum operator is given by

$$p = -i \partial = -i \gamma^\mu \partial_\mu \quad (70)$$

One can consider three distinct models:

- (i) *The non relativistic particle* moving in  $n$ dimensional curved space. Then,  $\mu = 1, 2, \dots, n$ , and signature is  $(+ + + + \dots)$ .
- (ii) *The relativistic particle* in curved spacetime, described by the *Schild action* [37]. Then,  $\mu = 0, 1, 2, \dots, n - 1$  and signature is  $(+ - - - \dots)$ .
- (iii) *The Stueckelberg unconstrained particle*. [33, 34, 35, 29].

In all three cases the classical action has the form

$$I[X^\mu] = \frac{1}{2\Lambda} \int d\tau g_{\mu\nu}(x) \dot{X}^\mu \dot{X}^\nu \quad (71)$$

and the corresponding Hamiltonian is

$$H = \frac{\Lambda}{2} g^{\mu\nu}(x) p_\mu p_\nu = \frac{\Lambda}{2} p^2 \quad (72)$$

If, upon quantization we take for the momentum operator  $p_\mu = -i \partial_\mu$ , then the ambiguity arises of how to write the quantum Hamilton operator. The problem occurs because the expressions  $g^{\mu\nu} p_\mu p_\nu$ ,  $p_\mu g^{\mu\nu} p_\nu$  and  $p_\mu p_\nu g^{\mu\nu}$  are not equivalent.

But, if we rewrite  $H$  as

$$H = \frac{\Lambda}{2} p^2 \quad (73)$$

where  $p = \gamma^\mu p_\mu$  is the *momentum vector* which upon quantization becomes the momentum vector operator (70), we find that there is no ambiguity in writing the square  $p^2$ . When acting with  $H$  on a *scalar* wave function  $\phi$  we obtain the unambiguous expression

$$H\phi = \frac{\Lambda}{2} p^2 \phi = \frac{\Lambda}{2} (-i)^2 (\gamma^\mu \partial_\mu) (\gamma^\nu \partial_\nu) \phi = -\frac{\Lambda}{2} D_\mu D^\mu \phi \quad (74)$$

in which there is no curvature term  $R$ . We expect that a term with  $R$  will arise upon acting with  $H$  on a *spinor* field  $\psi$ .

## 4.2 $C$ -space

Let us now consider  $C$ -space and review the procedure of ref. [20]. . A basis in  $C$ -space is given by

$$E_A = \{\gamma, \gamma_\mu, \gamma_\mu \wedge \gamma_\nu, \gamma_\mu \wedge \gamma_\nu \wedge \gamma_\rho, \dots\} \quad (75)$$

where in an  $r$ -vector  $\gamma_{\mu_1} \wedge \gamma_{\mu_2} \wedge \dots \wedge \gamma_{\mu_r}$  we take the indices so that  $\mu_1 < \mu_2 < \dots < \mu_r$ . An element of  $C$ -space is a Clifford number, called also *Polyvector* or *Clifford aggregate* which we now write in the form

$$X = X^A E_A = s \gamma + x^\mu \gamma_\mu + x^{\mu\nu} \gamma_\mu \wedge \gamma_\nu + \dots \quad (76)$$

A  $C$ -space is parametrized not only by 1-vector coordinates  $x^\mu$  but also by the 2-vector coordinates  $x^{\mu\nu}$ , 3-vector coordinates  $x^{\mu\nu\alpha}$ , etc., called also *holographic coordinates*, since they describe the holographic projections of 1-loops, 2-loops, 3-loops, etc., onto the coordinate planes. By  $p$ -loop we mean a closed  $p$ -brane; in particular, a 1-loop is closed string.

In order to avoid using the powers of the Planck scale length parameter  $L$  in the expansion of the polyvector  $X$  we use the dilatationally invariant units [15] in which  $L$  is set to 1. The dilation invariant physics was discussed from a different perspective also in refs. [23, 21].

In a flat  $C$ -space the basis vectors  $E^A$  are constants. In a curved  $C$ -space this is no longer true. Each  $E_A$  is a function of the  $C$ -space coordinates

$$X^A = \{s, x^\mu, x^{\mu\nu}, \dots\} \quad (77)$$

which include scalar, vector, bivector, ...,  $r$ -vector, ..., coordinates.

Now we define the connection  $\tilde{\Gamma}_{AB}^C$  in  $C$ -space according to

$$\partial_A E_B = \tilde{\Gamma}_{AB}^C E_C \quad (78)$$

where  $\partial_A \equiv \partial/\partial X^A$  is the derivative in  $C$ -space. This definition is analogous to the one in ordinary space. Let us therefore define the  $C$ -space curvature as

$$\mathcal{R}_{ABC}{}^D = ([\partial_A, \partial_B] E_C) * E^D \quad (79)$$

which is a straightforward generalization of the relation (68). The 'star' means the *scalar product* between two polyvectors  $A$  and  $B$ , defined as

$$A * B = \langle AB \rangle_S \quad (80)$$

where 'S' means 'the scalar part' of the geometric product  $AB$ .

In the following we shall explore the above relation for curvature and see how it is related to the curvature of the ordinary space. Before doing that we shall demonstrate that the derivative with respect to the bivector coordinate  $x^{\mu\nu}$  is equal to the commutator of the derivatives with respect to the vector coordinates  $x^\mu$ .

Returning now to eq.(78), the differential of a  $C$ -space basis vector is given by

$$dE_A = \frac{\partial E_A}{\partial X^B} dX^B = \Gamma_{AB}^C E_C dX^B \quad (81)$$

In particular, for  $A = \mu$  and  $E_A = \gamma_\mu$  we have

$$\begin{aligned} d\gamma_\mu &= \frac{\partial \gamma_\mu}{\partial X^\nu} dx^\nu + \frac{\partial \gamma_\mu}{\partial x^{\alpha\beta}} dx^{\alpha\beta} + \dots = \tilde{\Gamma}_{\nu\mu}^A E_A dx^\nu + \tilde{\Gamma}_{[\alpha\beta]\mu}^A E_A dx^{\alpha\beta} + \dots \\ &= (\tilde{\Gamma}_{\nu\mu}^\alpha \gamma_\alpha + \tilde{\Gamma}_{\nu\mu}^{[\rho\sigma]} \gamma_\rho \wedge \gamma_\sigma + \dots) dx^\nu \\ &\quad + (\tilde{\Gamma}_{[\alpha\beta]\mu}^\rho \gamma_\rho + \tilde{\Gamma}_{[\alpha\beta]\mu}^{[\rho\sigma]} \gamma_\rho \wedge \gamma_\sigma + \dots) dx^{\alpha\beta} + \dots \end{aligned} \quad (82)$$

We see that the differential  $d\gamma_\mu$  is in general a polyvector, i.e., a Clifford aggregate. In eq.(82) we have used

$$\frac{\partial \gamma_\mu}{\partial x^\nu} = \tilde{\Gamma}_{\nu\mu}^\alpha \gamma_\alpha + \tilde{\Gamma}_{\nu\mu}^{[\rho\sigma]} \gamma_\rho \wedge \gamma_\sigma + \dots \quad (83)$$

$$\frac{\partial \gamma_\mu}{\partial x^{\alpha\beta}} = \tilde{\Gamma}_{[\alpha\beta]\mu}^\rho \gamma_\rho + \tilde{\Gamma}_{[\alpha\beta]\mu}^{[\rho\sigma]} \gamma_\rho \wedge \gamma_\sigma + \dots \quad (84)$$

Let us now consider a *restricted* space in which the derivatives of  $\gamma_\mu$  with respect to  $x^\nu$  and  $x^{\alpha\beta}$  do not contain higher rank multivectors. Then eqs. (83),(84) become

$$\frac{\partial \gamma_\mu}{\partial x^\nu} = \tilde{\Gamma}_{\nu\mu}^\alpha \gamma_\alpha \quad (85)$$

$$\frac{\partial \gamma_\mu}{\partial x^{\alpha\beta}} = \tilde{\Gamma}_{[\alpha\beta]\mu}^\rho \gamma_\rho \quad (86)$$

Further we assume that

- (i) the components  $\tilde{\Gamma}_{\nu\mu}^\alpha$  of the  $C$ -space connection  $\tilde{\Gamma}_{AB}^C$  coincide with the connection  $\Gamma_{\nu\mu}^\alpha$  of an ordinary space.
- (ii) the components  $\tilde{\Gamma}_{[\alpha\beta]\mu}^\rho$  of the  $C$ -space connection coincide with the curvature tensor  $R_{\alpha\beta\mu}^\rho$  of an ordinary space.

Hence, eqs.(85),(86) read

$$\frac{\partial \gamma_\mu}{\partial x^\nu} = \Gamma_{\nu\mu}^\alpha \gamma_\alpha \quad (87)$$

$$\frac{\partial \gamma_\mu}{\partial x^{\alpha\beta}} = R_{\alpha\beta\mu}^\rho \gamma_\rho \quad (88)$$

and the differential (82) becomes

$$d\gamma_\mu = (\Gamma_{\alpha\mu}^\rho dx^\alpha + \frac{1}{2} R_{\alpha\beta\mu}^\rho dx^{\alpha\beta}) \gamma_\rho \quad (89)$$

The same relation was obtained by Pezzaglia [14] by using a different method, namely by considering how polyvectors change with position. The above relation demonstrates that a geodesic in  $C$ -space is not a geodesic in ordinary spacetime. Namely, in ordinary

spacetime we obtain Papapetrou's equation. This was previously pointed out by Pezzaglia [14].

Although a  $C$ -space connection does not transform like a  $C$ -space tensor, some of its components, i.e., those of eq. (86), may have the transformation properties of a tensor in an ordinary space.

Under a general coordinate transformation in  $C$ -space

$$X^A \rightarrow X'^A = X'^A(X^B) \quad (90)$$

the connection transforms according to<sup>4</sup>

$$\tilde{\Gamma}'^C_{AB} = \frac{\partial X'^C}{\partial X^E} \frac{\partial X^J}{\partial X'^A} \frac{\partial X^K}{\partial X'^B} \tilde{\Gamma}^E_{JK} + \frac{\partial X'^C}{\partial X^J} \frac{\partial^2 X^J}{\partial X'^A \partial X'^B} \quad (91)$$

In particular, the components which contain the bivector index  $A = [\alpha\beta]$  transform as

$$\tilde{\Gamma}'^{\rho}_{[\alpha\beta]\mu} = \frac{\partial X'^{\rho}}{\partial X^E} \frac{\partial X^J}{\partial \sigma'^{\alpha\beta}} \frac{\partial X^K}{\partial x'^{\mu}} \tilde{\Gamma}^E_{JK} + \frac{\partial x'^{\rho}}{\partial X^J} \frac{\partial^2 X^J}{\partial \sigma'^{\alpha\beta} \partial x'^{\mu}} \quad (92)$$

Let us now consider a particular class of coordinate transformations in  $C$ -space such that

$$\frac{\partial x'^{\rho}}{\partial x^{\mu\nu}} = 0, \quad \frac{\partial x^{\mu\nu}}{\partial x'^{\alpha}} = 0 \quad (93)$$

Then the second term in eq.(92) vanishes and the transformation becomes

$$\tilde{\Gamma}'^{\rho}_{[\alpha\beta]\mu} = \frac{\partial X'^{\rho}}{\partial x^{\epsilon}} \frac{\partial x^{\rho\sigma}}{\partial \sigma'^{\alpha\beta}} \frac{\partial x^{\gamma}}{\partial x'^{\mu}} \tilde{\Gamma}^{\epsilon}_{[\rho\sigma]\gamma} \quad (94)$$

Now, for the bivector whose components are  $dx^{\alpha\beta}$  we have

$$d\sigma'^{\alpha\beta} \gamma'_{\alpha} \wedge \gamma'_{\beta} = dx^{\alpha\beta} \gamma_{\alpha} \wedge \gamma_{\beta} \quad (95)$$

Taking into account that in our particular case (93)  $\gamma_{\alpha}$  transforms as a basis vector in an ordinary space

$$\gamma'_{\alpha} = \frac{\partial x^{\mu}}{\partial x'^{\alpha}} \gamma_{\mu} \quad (96)$$

we find that (95) and (96) imply

$$d\sigma'^{\alpha\beta} \frac{\partial x^{\mu}}{\partial x'^{\alpha}} \frac{\partial x^{\nu}}{\partial x'^{\beta}} = dx^{\mu\nu} \quad (97)$$

which means that

$$\frac{\partial x^{\mu\nu}}{\partial \sigma'^{\alpha\beta}} = \frac{1}{2} \left( \frac{\partial x^{\mu}}{\partial x'^{\alpha}} \frac{\partial x^{\nu}}{\partial x'^{\beta}} - \frac{\partial x^{\nu}}{\partial x'^{\alpha}} \frac{\partial x^{\mu}}{\partial x'^{\beta}} \right) \equiv \frac{\partial x^{[\mu}}{\partial x'^{\alpha}} \frac{\partial x^{\nu]}{\partial x'^{\beta}} \quad (98)$$

---

<sup>4</sup>This can be derived from the relation

$$dE'_A = \frac{\partial E'_A}{\partial X'^B} dX'^B \quad \text{where} \quad E'_A = \frac{\partial X^D}{\partial X'^A} E_D \quad \text{and} \quad dX'^B = \frac{\partial X'^B}{\partial X^C} dX^C$$

The transformation of the bivector coordinate  $x^{\mu\nu}$  is thus determined by the transformation of the vector coordinates  $x^\mu$ . This is so because the basis bivectors are the wedge products of basis vectors  $\gamma_\mu$ .

From (94) and (98) we see that  $\tilde{\Gamma}_{[\rho\sigma]\gamma}^\epsilon$  transforms like a 4th-rank tensor in an ordinary space.

Comparing eq.(88) with the relation (67) we find

$$\frac{\partial\gamma_\mu}{\partial x^{\alpha\beta}} = [\partial_\alpha, \partial_\beta]\gamma_\mu \quad (99)$$

The derivative of a basis vector with respect to the bivector coordinates  $x^{\alpha\beta}$  is equal to the commutator of the derivatives with respect to the vector coordinates  $x^\alpha$ .

The above relation (99) holds for the basis vectors  $\gamma_\mu$ . For an arbitrary polyvector

$$A = A^A E_A = s\gamma + a^\alpha \gamma_\alpha + a^{\alpha\beta} \gamma_\alpha \wedge \gamma_\beta + \dots \quad (100)$$

we will assume the validity of the following relation

$$\frac{DA^A}{Dx^{\mu\nu}} = [D_\mu, D_\nu]A^A \quad (101)$$

where  $D/Dx^{\mu\nu}$  is the covariant derivative, defined in analogous way as in eqs. (58):

$$\frac{DA^A}{DX^B} = \frac{\partial A^A}{\partial X^B} + \tilde{\Gamma}_{BC}^A A^C \quad (102)$$

From eq.(101) we obtain

$$\frac{Ds}{Dx^{\mu\nu}} = [D_\mu, D_\nu]s = K_{\mu\nu}^\rho \partial_\rho s \quad (103)$$

$$\frac{Da^\alpha}{Dx^{\mu\nu}} = [D_\mu, D_\nu]a^\alpha = R_{\mu\nu\rho}^\alpha a^\rho + K_{\mu\nu}^\rho D_\rho a^\alpha \quad (104)$$

Using (102) we have that

$$\frac{Ds}{Dx^{\mu\nu}} = \frac{\partial s}{\partial x^{\mu\nu}} \quad (105)$$

and

$$\frac{Da^\alpha}{Dx^{\mu\nu}} = \frac{\partial a^\alpha}{\partial x^{\mu\nu}} + \tilde{\Gamma}_{[\mu\nu]\rho}^\alpha a^\rho = \frac{\partial a^\alpha}{\partial x^{\mu\nu}} + R_{\mu\nu\rho}^\alpha a^\rho \quad (106)$$

where, according to (ii),  $\tilde{\Gamma}_{[\mu\nu]\rho}^\alpha$  has been identified with curvature. So we obtain, after inserting (105),(106) into (103),(104) that

- (a) the partial derivatives of the coefficients  $s$  and  $a^\alpha$ , which are Clifford scalars<sup>5</sup>, with respect to  $x^{\mu\nu}$  are related to *torsion*:

$$\frac{\partial s}{\partial x^{\mu\nu}} = K_{\mu\nu}^\rho \partial_\rho s \quad (107)$$

$$\frac{\partial a^\alpha}{\partial x^{\mu\nu}} = K_{\mu\nu}^\rho D_\rho a^\alpha \quad (108)$$

---

<sup>5</sup>In the geometric calculus based on Clifford algebra, the coefficients such as  $s$ ,  $a^\alpha$ ,  $a^{\alpha\beta}$ , ..., are called *scalars* (although in tensor calculus they are called scalars, vectors and tensors, respectively), whilst the objects  $\gamma_\alpha$ ,  $\gamma_\alpha \wedge \gamma_\beta$ , ..., are called *vectors*, *bivectors*, etc. .

(b) whilst the derivative of the basis vectors with respect to  $x^{\mu\nu}$  are related to *curvature*:

$$\frac{\partial \gamma_\alpha}{\partial x^{\mu\nu}} = R_{\mu\nu\alpha}{}^\beta \gamma_\beta \quad (109)$$

In other words, the dependence of coefficients  $s$  and  $a^\alpha$  on  $x^{\mu\nu}$  indicates the presence of torsion. On the contrary, when basis vectors  $\gamma_\alpha$  depend on  $x^{\mu\nu}$  this indicates that the corresponding vector space has non vanishing curvature.

### 4.3 On the relation between the curvature of $C$ -space and the curvature of an ordinary space

Let us now consider the  $C$ -space curvature defined in eq.(79) The indices  $A, B$ , can be of vector, bivector, etc., type. It is instructive to consider a particular example.

$$A = [\mu\nu], B = [\alpha\beta], C = \gamma, D = \delta$$

$$\left( \left[ \frac{\partial}{\partial x^{\mu\nu}}, \frac{\partial}{\partial x^{\alpha\beta}} \right] \gamma_\gamma \right) \cdot \gamma^\delta = \mathcal{R}_{[\mu\nu][\alpha\beta]\gamma}{}^\delta \quad (110)$$

Using (88) we have

$$\frac{\partial}{\partial x^{\mu\nu}} \frac{\partial}{\partial x^{\alpha\beta}} \gamma_\gamma = \frac{\partial}{\partial x^{\mu\nu}} (R_{\alpha\beta\gamma}{}^\rho \gamma_\rho) = R_{\alpha\beta\gamma}{}^\rho R_{\mu\nu\rho}{}^\sigma \gamma_\sigma \quad (111)$$

where we have taken

$$\frac{\partial}{\partial x^{\mu\nu}} R_{\alpha\beta\gamma}{}^\rho = 0 \quad (112)$$

which is true in the case of vanishing torsion (see also an explanation that follows after the next paragraph). Inserting (111) into (110) we find

$$\mathcal{R}_{[\mu\nu][\alpha\beta]\gamma}{}^\delta = R_{\mu\nu\gamma}{}^\rho R_{\alpha\beta\rho}{}^\delta - R_{\alpha\beta\gamma}{}^\rho R_{\mu\nu\rho}{}^\delta \quad (113)$$

which is the product of two usual curvature tensors. We can proceed in analogous way to calculate the other components of  $\mathcal{R}_{ABC}{}^D$  such as  $\mathcal{R}_{[\alpha\beta\gamma\delta][\rho\sigma]}{}^\mu$ ,  $\mathcal{R}_{[\alpha\beta\gamma\delta][\rho\sigma\tau\kappa]}{}^{[\mu\nu]}$ , etc.. These contain higher powers of the curvature in an ordinary space. All this is true in our restricted  $C$ -space given by eqs.(85),(86) and the assumptions (i),(ii) bellow those equations. By releasing those restrictions we would have arrived at an even more involved situation which is beyond the scope of the present paper.

After performing the contractions of (113) and the corresponding higher order relations we obtain the expansion of the form

$$\mathcal{R} = R + \alpha_1 R^2 + \alpha_2 R_{\mu\nu} R^{\mu\nu} + \dots \quad (114)$$

So we have shown that the  $C$ -space curvature can be expressed as the sum of the products of the ordinary spacetime curvature. This bears a resemblance to the string effective action in curved spacetimes given by sums of powers of the curvature tensors based on the quantization of non-linear sigma models [118].

If one sets aside the algebraic convergence problems when working with Clifford algebras in infinite dimensions, one can consider the possibility of studying Quantum Gravity in a very large number of dimensions which has been revisited recently [83] in connection to a perturbative renormalizable quantum theory of gravity in infinite dimensions. Another interesting possibility is that an infinite series expansion of the powers of the scalar curvature could yield the recently proposed modified Lagrangians  $R + 1/R$  of gravity to accommodate the cosmological accelerated expansion of the Universe [131], after a judicious choice of the algebraic coefficients is taken. One may notice also that having a vanishing cosmological constant in C-space,  $\mathcal{R} = \Lambda = 0$  does not necessarily imply that one has a vanishing cosmological constant in ordinary spacetime. For example, in the very special case of homogeneous symmetric spacetimes, like spheres and hyperboloids, where all the curvature tensors are proportional to suitable combinations of the metric tensor times the scalar curvature, it is possible to envision that the net combination of the sum of all the powers of the curvature tensors may cancel-out giving an overall zero value  $\mathcal{R} = 0$ . This possibility deserves investigation.

Let us now show that for vanishing torsion the curvature is independent of the bivector coordinates  $x^{\mu\nu}$ , as it was taken in eq.(112). Consider the basic relation

$$\gamma_\mu \cdot \gamma_\nu = g_{\mu\nu} \quad (115)$$

Differentiating with respect to  $x^{\alpha\beta}$  we have

$$\frac{\partial}{\partial x^{\alpha\beta}}(\gamma_\mu \cdot \gamma_\nu) = \frac{\partial \gamma_\mu}{\partial x^{\alpha\beta}} \cdot \gamma_\nu + \gamma_\mu \cdot \frac{\partial \gamma_\nu}{\partial x^{\alpha\beta}} = R_{\alpha\beta\mu\nu} + R_{\alpha\beta\nu\mu} = 0 \quad (116)$$

This implies that

$$\frac{\partial g_{\mu\nu}}{\partial \sigma_{\alpha\beta}} = [\partial_\alpha, \partial_\beta]g_{\mu\nu} = 0 \quad (117)$$

Hence the metric, in this particular case, is independent of the holographic (bivector) coordinates. Since the curvature tensor —when torsion is zero— can be written in terms of the metric tensor and its derivatives, we conclude that not only the metric, but also the curvature is independent of  $x^{\mu\nu}$ . In general, when the metric has a dependence on the holographic coordinates one expects further corrections to eq.(113) that would include torsion.

## 5 On the Quantization in C-spaces

### 5.1 The momentum constraint in C-space

A detailed discussion of the physical properties of all the components of the polymomentum  $P$  in four dimensions and the emergence of the physical mass in Minkowski spacetime has been provided in the book [15]. The polymomentum in  $D = 4$ , canonically conjugate to the position polyvector

$$X = \sigma + x^\mu \gamma_\mu + \gamma^{\mu\nu} \gamma_\mu \wedge \gamma_\nu + \xi^\mu \gamma_5 \gamma_\mu + s \gamma_5 \quad (118)$$



can be written as:

$$P = \mu + p^\mu \gamma_\mu + S^{\mu\nu} \gamma_\mu \wedge \gamma_\nu + \pi^\mu \gamma_5 \gamma_\mu + m \gamma_5. \quad (119)$$

where besides the vector components  $p^\mu$  we have the scalar component  $\mu$ , the 2-vector components  $S^{\mu\nu}$ , that are connected to the spin as shown by [14]; the pseudovector components  $\pi^\mu$  and the pseudoscalar component  $m$ .

The most salient feature of the polyparticle dynamics in C-spaces [15] is that one can start with a *constrained* action in C-space and arrive, nevertheless, at an *unconstrained* Stuckelberg action in Minkowski space (a subspace of C-space) in which  $p_\mu p^\mu$  is a constant of motion. The true constraint in C-space is:

$$P_A P^A = \mu^2 + p_\mu p^\mu - 2S^{\mu\nu} S_{\mu\nu} + \pi_\mu \pi^\mu - m^2 = M^2. \quad (120)$$

where  $M$  is a *fixed* constant, the mass in C-space. The pseudoscalar component  $m$  is a variable, like  $\mu$ ,  $p_\mu$ ,  $S^{\mu\nu}$ , and  $\pi^\mu$ , which altogether are constrained according to eq.(120). It becomes the physical mass in Minkowski spacetime in the special case when other extra components vanish, i.e., when  $\mu = 0$ ,  $S^{\mu\nu} = 0$  and  $\pi^\mu = 0$ . This justifies using the notation  $m$  for mass. This is basically the distinction between the mass in Minkowski space which is a constant of motion  $p_\mu p^\mu$  and the fixed mass  $M$  in C-space. The variable  $m$  is canonically conjugate to  $s$  which acquires the role of the Stuckelberg evolution parameter  $s$  that allowed ref.[29, 15] to propose a natural solution of the problem of time in quantum gravity. The polyparticle dynamics in C-space is a generalization of the relativistic Regge top construction which has recently been studied in de Sitter spaces by [135].

A derivation of a charge, mass, and spin relationship of a polyparticle can be obtained from the above polymomentum constraint in C-space if one relates the norm of the axial-momentum component  $\pi^\mu$  of the polymomentum  $P$  to the charge [80]. It agrees exactly with the recent charge-mass-spin relationship obtained by [44] based on the Kerr-Newman black hole metric solutions of the Einstein-Maxwell equations. The naked singularity Kerr-Newman solutions have been interpreted by [45] as Dirac particles. Further investigation is needed to understand better these relationships, in particular, the deep reasons behind the *charge* assignment to the norm of the axial-vector  $\pi^\mu$  component of the polymomentum which suggests that mass has a gravitational, electromagnetic and rotational aspects to it. In a Kaluza-Klein reduction from  $D = 5$  to  $D = 4$  it is well known that the electric charge is related to the  $p_5$  component of the momentum. Hence, charge bears a connection to an internal momentum.

## 5.2 C-space Klein-Gordon and Dirac Wave Equations

The ordinary Klein-Gordon equation can be easily obtained by implementing the on-shell constraint  $p^2 - m^2 = 0$  as an operator constraint on the physical states after replacing  $p_\mu$  for  $-i\partial/\partial x^\mu$  (we use units in which  $\hbar = 1, c = 1$ ):

$$\left( \frac{\partial^2}{\partial x^\mu \partial x_\mu} + m^2 \right) \phi = 0. \quad (121)$$

The C-space generalization follows from the  $P^2 - M^2 = 0$  condition by replacing

$$P_A \rightarrow -i \frac{\partial}{\partial X^A} = -i \left( \frac{\partial}{\partial \sigma}, \frac{\partial}{\partial x^\mu}, \frac{\partial}{\partial x^{\mu\nu}}, \dots \right) \quad (122)$$

$$\left( \frac{\partial^2}{\partial \sigma^2} + \frac{\partial^2}{\partial x^\mu \partial x_\mu} + \frac{\partial^2}{\partial x^{\mu\nu} \partial x_{\mu\nu}} + \dots + M^2 \right) \Phi = 0 \quad (123)$$

where we have set  $L = \hbar = c = 1$  for convenience purposes and the C-space scalar field  $\Phi(\sigma, x^\mu, x^{\mu\nu}, \dots)$  is a polyvector-valued *scalar* function of *all* the C-space variables. This is the Klein-Gordon equation associated with a free scalar polyparticle in C-space.

A wave equation for a generalized C-space harmonic oscillator requires to introduce the potential of the form  $V = \kappa X^2$  that admits straightforward solutions in terms of Gaussians and Hermite polynomials similar to the ordinary point-particle oscillator. There are now collective excitations of the Clifford-oscillator in terms of the number of Clifford-bits and which represent the quanta of areas, volumes, hypervolumes, ..., associated with the p-loops oscillations in Planck scale units. The logarithm of the degeneracy of the first collective state of the C-space oscillator, as a function of the number of bits, bears the same functional form as the Bekenstein-Hawking black hole entropy, with the upshot that one recovers, in a natural way, the logarithmic corrections to the black-hole entropy as well, if one identifies the number of Clifford-bits with the number of area-quanta of the black hole horizon. For further details about this derivation and the emergence of the Schwarzschild horizon radius relation, the Hawking temperature, the maximal Planck temperature condition, etc., we refer to [21]. Perhaps the most important consequence of this latter view of black hole entropy is the possibility that there is a ground state of quantum spacetime, resulting from of a Bose-Einstein condensate of the C-space harmonic oscillator.

A C-space version of the Dirac Equation, representing the dynamics of spinning-polyparticles (theories of extended-spin, extended charges) is obtained via the square-root procedure of the Klein-Gordon equation:

$$-i \left( \frac{\partial}{\partial \sigma} + \gamma^\mu \frac{\partial}{\partial x_\mu} + \gamma^\mu \wedge \gamma^\nu \frac{\partial}{\partial x_{\mu\nu}} + \dots \right) \Psi = M \Psi \quad (124)$$

where  $\Psi(\sigma, x^\mu, x^{\mu\nu}, \dots)$  is a polyvector-valued function, a Clifford-number,  $\Psi = \Psi^A E_A$  of *all* the C-space variables. For simplicity we consider here a *flat* C-space in which the metric  $G_{AB} = E_A^\dagger * E_B = \eta_{AB}$  is diagonal,  $\eta_{AB}$  being the C-space analog of Minkowski tensor. In curved C-space the equation (124) should be properly generalized. This goes beyond the scope of the present paper.

Ordinary spinors are nothing but elements of the left/right ideals of a Clifford algebra. So they are automatically contained in the polyvector valued wave function  $\Psi$ . The ordinary Dirac equation can be obtained when  $\Psi$  is independent of the extra variables associated with a polyvector-valued coordinates  $X$  (i.e., of  $x^{\mu\nu}, x^{\mu\nu\rho}, \dots$ ). For details see [15].

Thus far we have written ordinary wave equations in C-space, that is, we considered the wave equations for a “point particle” in C-space. From the perspective of the 4-dimensional Minkowski spacetime the latter “point particle” has, of course, a much richer

structure then a mere point: it is an extended object, modeled by coordinates  $x^\mu, x^{\mu\nu}, \dots$ . But such modeling does not embrace all the details of an extended object. In order to provide a description with more details, one can consider not the “point particles” in  $C$ -space, but *branes* in  $C$ -space. They are described by the embeddings  $X = X(\Sigma)$ , that is  $X^M = X^M(\Sigma^A)$ , considered in sec.3.2. Quantization of such branes can employ wave functional equation, or other methods, including the second quantization formalism. For a more detailed study of the second quantization of extended objects using the tools of Clifford algebra see [15].

Without employing Clifford algebra a lot of illuminating work has been done in relation to description of branes in terms of p-loop coordinates [132]. A bosonic/fermionic p-brane wave-functional equation was presented in [12], generalizing the closed-string(loop) results in [13] and the quantum bosonic p-brane propagator, in the quenched-reduced minisuperspace approximation, was attained by [18]. In the latter work branes are described in terms of the collective coordinates which are just the highest grade components in the expansion of a polyvector  $X$  given in eq (2). This work thus paved the way for the next logical step, that is, to consider other multivector components of  $X$  in a unified description of all branes.

Notice that the approach based on eqs.(123),(124) is different from that by Hestenes [1] who proposed an equation which is known as the Dirac-Hestenes equation. Dirac’s equation using quaternions (related to Clifford algebras) was first derived by Lanczos [91]. Later on the Dirac-Lanczos equation was rediscovered by many people, in particular by Hestenes and Gursev [92] in what became known as the Dirac-Hestenes equation. The former Dirac-Lanczos equation is Lorentz *covariant* despite the fact that it singles out an arbitrary but unique direction in ordinary space: the *spin* quantization axis. Lanczos, without knowing, had anticipated the existence of isospin as well. The Dirac-Hestenes equation  $\partial\Psi e_{21} = m\Psi e_o$  is *covariant* under a change of frame [133], [93].  $e'_\mu = U e_\mu U^{-1}$  and  $\Psi' = \Psi U^{-1}$  with  $U$  an element of the  $Spin_+(1,3)$  yielding  $\partial\Psi' e'_{21} = m\Psi' e'_o$ . As Lanczos had anticipated, in a new frame of reference, the spin quantization axis is also rotated appropriately, thus there is no breakdown of covariance by introducing bivectors in the Dirac-Hestenes equation.

However, subtleties still remain. In the Dirac-Hestenes equation instead of the imaginary unit  $i$  there occurs the bivector  $\gamma_1\gamma - 2$ . Its square is  $-1$  and commutes with all the elements of the Dirac algebra which is just a desired property. But on the other hand, the introduction of a bivector into an equation implies a selection of a preferred orientation in spacetime; i.e. the choice of the spin quantization axis in the original Dirac-Lanczos quaternionic equation. How is such preferred orientation (spin quantization axis) determined? Is there some dynamical symmetry which determines the preferred orientation (spin quantization axis)? is there an action which encodes a hidden dynamical principle that selects *dynamically* a preferred spacetime orientation (spin quantization axis)?

Many subtleties of the Dirac-Hestenes equation and its relation to the ordinary Dirac equation and the Seiberg-Witten equation are investigated from the rigorous mathematical point of view in refs. [93]. The approach in refs. [16, 15, 17, 8], reviewed here, is different. We start from the usual formulation of quantum theory and extend it to  $C$ -space. We retain the imaginary unit  $i$ . Next step is to give a geometric interpretation to  $i$ . Instead

of trying to find a geometric origin of  $i$  in *spacetime* we adopt the interpretation proposed in [15] according to which the  $i$  is the bivector of the 2-dimensional *phase space* (whose direct product with the  $n$ -dimensional configuration space gives the  $2n$ -dimensional phase space).<sup>6</sup> This appears to be a natural assumption due to the fact that complex valued quantum mechanical wave functions involve momenta  $p_\mu$  and coordinates  $x^\mu$  (e.g., a plane wave is given by  $\exp[ip_\mu x^\mu]$ , and arbitrary wave packet is a superposition of plane waves).

## 6 Maximal-Acceleration Relativity in Phase-Spaces

In this section we shall discuss the maximal acceleration Relativity principle [68] based on Finsler geometry which does not destroy, nor deform, Lorentz invariance. Our discussion differs from the pseudo-complex Lorentz group description by Schuller [61] related to the effects of maximal acceleration in Born-Infeld models that also maintains Lorentz invariance, in contrast to the approaches of Double Special Relativity (DSR). In addition one does not need to modify the energy-momentum addition (conservation) laws in the scattering of particles which break translational invariance. For a discussions on the open problems of Double Special Relativity theories based on kappa-deformed Poincare symmetries [63] and motivated by the anomalous Lorentz-violating dispersion relations in the ultra high energy cosmic rays [71, 72, 73], we refer to [70].

Related to the minimal Planck scale, an upper limit on the maximal acceleration principle in Nature was proposed by long ago Cainello [52]. This idea is a direct consequence of a suggestion made years earlier by Max Born on a Dual Relativity principle operating in phase spaces [49], [74] where there is an upper bound on the four-force (maximal string tension or tidal forces in the string case) acting on a particle as well as an upper bound in the particle velocity. One can combine the maximum speed of light with a minimum Planck scale into a maximal proper-accleration  $a = c^2/L =$  within the framework of Finsler geometry [56]. For a recent status of the geometries behind maximal-acceleration see [73]; its relation to the Double Special Relativity programs was studied by [55] and the possibility that Moyal deformations of Poincare algebras could be related to the kappa-deformed Poincare algebras was raised in [68]. A thorough study of Finsler geometry and Clifford algebras has been undertaken by Vacaru [81] where Clifford/spinor structures were defined with respect to Nonlinear connections associated with certain nonholonomic modifications of Riemann–Cartan gravity.

Other several new physical implications of the maximal acceleration principle in Nature, like neutrino oscillations and other phenomena, have been studied by [54], [67], [42]. Recently, the variations of the fine structure constant  $\alpha$  [64], with the cosmological accelerated expansion of the Universe, was recast as a renormalization group-like equation governing the cosmological reshift (Universe scale) variations of  $\alpha$  based on this maximal acceleration principle in Nature [68]. The fine structure constant was smaller in the past. Pushing the cutoff scale to the minimum Planck scale led to the intriguing result that the fine structure constant could have been extremely small (zero) in the early Universe

---

<sup>6</sup>Yet another interpretation of the imaginary unit  $i$  present in the Heisenberg uncertainty relations has been undertaken by Finkelstein and collaborators [96].

and that all matter in the Universe could have emerged via the Unruh-Rindler-Hawking effect (creation of radiation/matter) due to the acceleration w.r.t the vacuum frame of reference. For reviews on the alledged variations of the fundamental constants in Nature see [65] and for more astonishing variations of  $\alpha$  driven by quintessence see [66].

## 6.1 Clifford algebras in Phase space

We shall employ the procedure described in [15] to construct the Phase Space Clifford algebra that allowed [127] to reproduce the sub-maximally accelerated particle action of [53].

For simplicity we will focus on a two-dim phase space. Let  $e_p, e_q$  be the Clifford-algebra basis elements in a two-dim phase space obeying the following relations [15]:

$$e_p \cdot e_q \equiv \frac{1}{2}(e_q e_p + e_p e_q) = 0. \quad (125)$$

and  $e_p \cdot e_p = e_q \cdot e_q = 1$ .

The Clifford product of  $e_p, e_q$  is by definition the sum of the scalar and the wedge product:

$$e_p e_q = e_p \cdot e_q + e_p \wedge e_q = 0 + e_p \wedge e_q = i. \quad (126)$$

such that  $i^2 = e_p e_q e_p e_q = -1$ . Hence, the imaginary unit  $i$ ,  $i^2 = -1$  admits a very natural interpretation in terms of Clifford algebras, i.e., it is represented by the wedge product  $i = e_p \wedge e_q$ , a phase-space area element. Such imaginary unit allows us to express vectors in a C-phase space in the form:

$$\begin{aligned} Q &= Q = q e_q + p e_p \\ Q e_q &= q + p e_p e_q = q + i p = z \\ e_q Q &= q + p e_q e_p = q - i p = z^* \end{aligned} \quad (127)$$

which reminds us of the creation/annihilation operators used in the harmonic oscillator.

We shall now review the steps in [127] to reproduce the sub-maximally accelerated particle action [53]. The phase-space analog of the spacetime action is:

$$dQ \cdot dQ = (dq)^2 + (dp)^2 \Rightarrow S = m \int \sqrt{(dq)^2 + (dp)^2}. \quad (128)$$

Introducing the appropriate length/mass scale parameters in order to have consistent units yields:

$$S = m \int \sqrt{(dq)^2 + \left(\frac{L}{m}\right)^2 (dp)^2}. \quad (129)$$

where we have introduced the Planck scale  $L$  and have chosen the natural units  $\hbar = c = 1$ . A detailed physical discussion of the dilational invariant system of units  $\hbar = c = G = 4\pi\epsilon_0 = 1$  was presented in ref. [15].  $G$  is the Newton constant and  $\epsilon_0$  is the permittivity of the vacuum.

Extending this two-dim result to a  $2n$ -dim phase space result requires to have for Clifford basis the elements  $e_{p_\mu}, e_{q_\mu}$ , where  $\mu = 1, 2, 3, \dots, n$ . The action in the  $2n$ -dim phase space is:

$$S = m \int \sqrt{(dq^\mu dq_\mu) + \left(\frac{L}{m}\right)^2 (dp^\mu dp_\mu)} = m \int d\tau \sqrt{1 + \left(\frac{L}{m}\right)^2 (dp^\mu/d\tau)(dp_\mu/d\tau)}. \quad (130)$$

where we have factored-out of the square-root the infinitesimal proper-time displacement  $(d\tau)^2 = dq^\mu dq_\mu$ .

One can recognize the action (130), up to a numerical factor of  $m/a$ , where  $a$  is the proper acceleration, as the same action for a sub-maximally accelerated particle given by Nesterenko [53] by rewriting  $(dp^\mu/d\tau) = m(d^2x^\mu/d\tau^2)$ :

$$S = m \int d\tau \sqrt{1 + L^2(d^2x^\mu/d\tau^2)(d^2x_\mu/d\tau^2)}. \quad (131)$$

Postulating that the maximal proper-acceleration is given in terms of the speed of light and the minimal Planck scale by  $a = c^2/L = 1/L$ , the action above gives the Nesterenko action, up to a numerical  $m/a$  factor:

$$S = m \int d\tau \sqrt{1 + a^{-2}(d^2x^\mu/d\tau^2)(d^2x_\mu/d\tau^2)}. \quad (132)$$

The proper-acceleration is orthogonal to the proper-velocity and this can be easily verified by differentiating the timelike proper-velocity squared:

$$V^2 = \frac{dx^\mu}{d\tau} \frac{dx_\mu}{d\tau} = V^\mu V_\mu = 1 > 0 \Rightarrow \frac{dV^\mu}{d\tau} V_\mu = \frac{d^2x^\mu}{d\tau^2} V_\mu = 0. \quad (133)$$

which implies that the proper-acceleration is spacelike:

$$g^2(\tau) = -\frac{d^2x^\mu}{d\tau^2} \frac{d^2x_\mu}{d\tau^2} > 0 \Rightarrow S = m \int d\tau \sqrt{1 - \frac{g^2}{a^2}} = m \int d\omega. \quad (134)$$

where the analog of the Lorentz time-dilation factor for a sub-maximally accelerated particle is given by

$$d\omega = d\tau \sqrt{1 - \frac{g^2(\tau)}{a^2}}. \quad (135)$$

Therefore the dynamics of a sub-maximally accelerated particle can be reinterpreted as that of a particle moving in the spacetime tangent bundle whose Finsler-like metric is

$$(d\omega)^2 = g_{\mu\nu}(x^\mu, dx^\mu) dx^\mu dx^\nu = (d\tau)^2 \left(1 - \frac{g^2(\tau)}{a^2}\right). \quad (136)$$

The invariant time now is no longer the standard proper-time  $\tau$  but is given by the quantity  $\omega(\tau)$ . The deep connection between the physics of maximal acceleration and Finsler geometry has been analyzed by [56]. This sort of actions involving second derivatives have also been studied in the construction of actions associated with rigid particles (strings) [57], [58], [59], [60] among others.

The action is real-valued if, and only if,  $g^2 < a^2$  in the same fashion that the action in Minkowski spacetime is real-valued if, and only if,  $v^2 < c^2$ . This is the physical reason why there is an upper bound in the proper-acceleration. In the special case of uniformly-accelerated motion  $g(\tau) = g_o = \text{constant}$ , the trajectory of the particle in Minkowski spacetime is a hyperbola.

Most recently, an Extended Relativity Theory in Born-Clifford-Phase spaces with an *upper* and *lower* length scales (infrared/ultraviolet cutoff ) has been constructed [138]. The invariance symmetry associated with an 8D Phase Space leads naturally to the real Clifford algebra  $Cl(2, 6, R)$  and complexified Clifford  $Cl_C(4)$  algebra related to Twistors. The consequences of Mach's principle of inertia within the context of Born's Dual Phase Space Relativity Principle were also studied in [138] and they were compatible with the Eddington-Dirac large numbers coincidence and with the observed values of the anomalous Galileo-Pioneer acceleration. The modified Newtonian dynamics due to the upper/lower scales and modified Schwarzschild dynamics due the maximal acceleration were also provided.

## 6.2 Invariance under the $U(1, 3)$ Group

In this section we will review in detail the principle of Maximal-acceleration Relativity [68] from the perspective of 8D Phase Spaces and the  $U(1, 3)$  Group. The  $U(1, 3) = SU(1, 3) \otimes U(1)$  Group transformations, which leave invariant the phase-space intervals under rotations, velocity and acceleration boosts, were found by Low [74] and can be simplified drastically when the velocity/acceleration boosts are taken to lie in the  $z$ -direction, leaving the transverse directions  $x, y, p_x, p_y$  intact ; i.e., the  $U(1, 1) = SU(1, 1) \otimes U(1)$  subgroup transformations that leave invariant the phase-space interval are given by (in units of  $\hbar = c = 1$ )

$$\begin{aligned} (d\sigma)^2 &= (dT)^2 - (dX)^2 + \frac{(dE)^2 - (dP)^2}{b^2} = \\ (d\tau)^2 \left[ 1 + \frac{(dE/d\tau)^2 - (dP/d\tau)^2}{b^2} \right] &= (d\tau)^2 \left[ 1 - \frac{m^2 g^2(\tau)}{m_P^2 A_{max}^2} \right]. \end{aligned} \quad (137)$$

where we have factored out the proper time infinitesimal  $(d\tau)^2 = dT^2 - dX^2$  in eq.(137) and the maximal proper-force is set to be  $b \equiv m_P A_{max}$ .  $m_P$  is the Planck mass  $1/L_P$  so that  $b = (1/L_P)^2$ , may also be interpreted as the maximal string tension when  $L_P$  is the Planck scale.

The quantity  $g(\tau)$  is the proper four-acceleration of a particle of mass  $m$  in the  $z$ -direction which we take to be  $X$ . Notice that the invariant interval  $(d\sigma)^2$  in eq.(137) is not strictly the *same* as the interval  $(d\omega)^2$  of the Nesterenko action eq.(132), which was invariant under a pseudo-complexification of the Lorentz group [61]. Only when  $m = m_P$ , the two intervals agree. The interval  $(d\sigma)^2$  described by Low [74] is  $U(1, 3)$ -invariant for the most general transformations in the 8D phase-space. These transformations are rather elaborate, so we refer to the references [74] for details. The analog of the Lorentz relativistic factor in eq.(137) involves the ratios of two proper *forces*. One variable force is given by  $ma$  and the maximal proper force sustained by an *elementary* particle of

mass  $m_P$  (a *Planckton*) is assumed to be  $F_{max} = m_{Planck}c^2/L_P$ . When  $m = m_P$ , the ratio-squared of the forces appearing in the relativistic factor of eq.(137) becomes then  $g^2/A_{max}^2$ , and the phase space interval (137) coincides with the geometric interval of (132).

The transformations laws of the coordinates in that leave invariant the interval (137) are [74]:

$$T' = T \cosh \xi + \left( \frac{\xi_v X}{c^2} + \frac{\xi_a P}{b^2} \right) \frac{\sinh \xi}{\xi}. \quad (138)$$

$$E' = E \cosh \xi + (-\xi_a X + \xi_v P) \frac{\sinh \xi}{\xi}. \quad (139)$$

$$X' = X \cosh \xi + \left( \xi_v T - \frac{\xi_a E}{b^2} \right) \frac{\sinh \xi}{\xi}. \quad (140)$$

$$P' = P \cosh \xi + \left( \frac{\xi_v E}{c^2} + \xi_a T \right) \frac{\sinh \xi}{\xi}. \quad (141)$$

The  $\xi_v$  is velocity-boost rapidity parameter and the  $\xi_a$  is the force/acceleration-boost rapidity parameter of the primed-reference frame. They are defined respectively (in the special case when  $m = m_P$ ):

$$\begin{aligned} \tanh\left(\frac{\xi_v}{c}\right) &= \frac{v}{c} \\ \tanh\frac{\xi_a}{b} &= \frac{ma}{m_P A_{max}}. \end{aligned} \quad (142)$$

The *effective* boost parameter  $\xi$  of the  $U(1,1)$  subgroup transformations appearing in eqs.(138)–(141) is defined in terms of the velocity and acceleration boosts parameters  $\xi_v, \xi_a$  respectively as:

$$\xi \equiv \sqrt{\frac{\xi_v^2}{c^2} + \frac{\xi_a^2}{b^2}}. \quad (143)$$

Our definition of the rapidity parameters are *different* than those in [74].

Straightforward algebra allows us to verify that these transformations leave the interval of eq.(137) in classical phase space invariant. They are fully consistent with Born's duality Relativity symmetry principle [49]  $(Q, P) \rightarrow (P, -Q)$ . By inspection we can see that under Born duality, the transformations in eqs.(138)–(141) are *rotated* into each other, up to numerical  $b$  factors in order to match units. When on sets  $\xi_a = 0$  in (138)–(141) one recovers automatically the standard Lorentz transformations for the  $X, T$  and  $E, P$  variables *separately*, leaving invariant the intervals  $dT^2 - dX^2 = (d\tau)^2$  and  $(dE^2 - dP^2)/b^2$  separately.

When one sets  $\xi_v = 0$  we obtain the transformations rules of the events in Phase space, from one reference-frame into another *uniformly*-accelerated frame of reference,  $a = \text{constant}$ , whose acceleration-rapidity parameter is in this particular case:

$$\xi \equiv \frac{\xi_a}{b}. \quad \tanh \xi = \frac{ma}{m_P A_{max}}. \quad (144)$$

The transformations for pure acceleration-booster in are:

$$T' = T \cosh \xi + \frac{P}{b} \sinh \xi. \quad (145)$$



$$E' = E \cosh \xi - bX \sinh \xi. \quad (146)$$

$$X' = X \cosh \xi - \frac{E}{b} \sinh \xi \quad (147)$$

$$P' = P \cosh \xi + bT \sinh \xi. \quad (148)$$

It is straightforward to verify that the transformations (145)–(147) leave invariant the fully phase space interval (137) but *does not* leave invariant the proper time interval  $(d\tau)^2 = dT^2 - dX^2$ . Only the *combination*:

$$(d\sigma)^2 = (d\tau)^2 \left(1 - \frac{m^2 g^2}{m_P^2 A_{max}^2}\right) \quad (149)$$

is truly left invariant under pure acceleration-boosts (145)–(147). One can verify as well that these transformations satisfy Born's duality symmetry principle:

$$(T, X) \rightarrow (E, P). \quad (E, P) \rightarrow (-T, -X). \quad (150)$$

and  $b \rightarrow \frac{1}{b}$ . The latter Born duality transformation is nothing but a manifestation of the large/small tension duality principle reminiscent of the  $T$ -duality symmetry in string theory; i.e. namely, a small/large radius duality, a winding modes/ Kaluza-Klein modes duality symmetry in string compactifications and the Ultraviolet/Infrared entanglement in Noncommutative Field Theories. Hence, Born's duality principle in exchanging coordinates for momenta could be the underlying physical reason behind  $T$ -duality in string theory.

The composition of two successive pure acceleration-boosts is another pure acceleration-boost with acceleration rapidity given by  $\xi'' = \xi + \xi'$ . The addition of *proper* four-forces ( accelerations ) follows the usual relativistic composition rule:

$$\tanh \xi'' = \tanh(\xi + \xi') = \frac{\tanh \xi + \tanh \xi'}{1 + \tanh \xi \tanh \xi'} \Rightarrow \frac{ma''}{m_P A} = \frac{\frac{ma}{m_P A} + \frac{ma'}{m_P A}}{1 + \frac{m^2 aa'}{m_P^2 A^2}}. \quad (151)$$

and in this fashion the upper limiting *proper* acceleration is never *surpassed* like it happens with the ordinary Special Relativistic addition of velocities.

The group properties of the full combination of velocity and acceleration boosts (138)–(141) requires much more algebra [68]. A careful study reveals that the composition *rule* of two successive full transformations is given by  $\xi'' = \xi + \xi'$  and the transformation laws are *preserved* if, and only if, the  $\xi; \xi'; \xi''$ ..... parameters obeyed the suitable relations:

$$\frac{\xi_a}{\xi} = \frac{\xi'_a}{\xi'} = \frac{\xi''_a}{\xi''} = \frac{\xi''_a}{\xi + \xi'}. \quad (152)$$

$$\frac{\xi_v}{\xi} = \frac{\xi'_v}{\xi'} = \frac{\xi''_v}{\xi''} = \frac{\xi''_v}{\xi + \xi'}. \quad (153)$$

Finally we arrive at the composition law for the effective, velocity and acceleration boosts parameters  $\xi''; \xi''_v; \xi''_a$  respectively:

$$\xi_v'' = \xi_v + \xi_v' \quad (154)$$

$$\xi_a'' = \xi_a + \xi_a' \quad (155)$$

$$\xi'' = \xi + \xi' \quad (156)$$

The relations (152, 153, 154, 155, 156) are required in order to prove the *group* composition law of the transformations of (138)–(141) and, consequently, in order to have a truly Maximal-Acceleration Phase Space Relativity theory resulting from a phase-space change of coordinates in the cotangent bundle of spacetime.

### 6.3 Planck-Scale Areas are Invariant under Acceleration Boosts

Having displayed explicitly the Group transformations rules of the coordinates in Phase space we will show why *infinite* acceleration-boosts (which is *not* the same as infinite proper acceleration) preserve Planck-Scale *Areas* [68] as a result of the fact that  $b = (1/L_P^2)$  equals the *maximal* invariant force, or string tension, if the units of  $\hbar = c = 1$  are used.

At Planck-scale  $L_P$  intervals/increments in one reference frame we have by definition (in units of  $\hbar = c = 1$ ):  $\Delta X = \Delta T = L_P$  and  $\Delta E = \Delta P = \frac{1}{L_P}$  where  $b \equiv \frac{1}{L_P^2}$  is the maximal tension. From eqs.(138)–(141) we get for the transformation rules of the finite intervals  $\Delta X, \Delta T, \Delta E, \Delta P$ , from one reference frame into another frame, in the *infinite* acceleration-boost limit  $\xi \rightarrow \infty$ ,

$$\Delta T' = L_P(\cosh\xi + \sinh\xi) \rightarrow \infty \quad (157)$$

$$\Delta E' = \frac{1}{L_P}(\cosh\xi - \sinh\xi) \rightarrow 0 \quad (158)$$

by a simple use of L'Hopital's rule or by noticing that both  $\cosh\xi; \sinh\xi$  functions approach infinity at the same rate.

$$\Delta X' = L_P(\cosh\xi - \sinh\xi) \rightarrow 0. \quad (159)$$

$$\Delta P' = \frac{1}{L_P}(\cosh\xi + \sinh\xi) \rightarrow \infty \quad (160)$$

where the discrete displacements of two events in Phase Space are defined:  $\Delta X = X_2 - X_1 = L_P$ ,  $\Delta E = E_2 - E_1 = \frac{1}{L_P}$ ,  $\Delta T = T_2 - T_1 = L_P$  and  $\Delta P = P_2 - P_1 = \frac{1}{L_P}$ .

Due to the identity:

$$(\cosh\xi + \sinh\xi)(\cosh\xi - \sinh\xi) = \cosh^2\xi - \sinh^2\xi = 1 \quad (161)$$

one can see from eqs.(157)–(160) that the Planck-scale *Areas* are truly *invariant* under *infinite* acceleration-boosts  $\xi = \infty$ :

$$\Delta X' \Delta P' = 0 \times \infty = \Delta X \Delta P (\cosh^2\xi - \sinh^2\xi) = \Delta X \Delta P = \frac{L_P}{L_P} = 1. \quad (162)$$

$$\Delta T' \Delta E' = \infty \times 0 = \Delta T \Delta E (\cosh^2 \xi - \sinh^2 \xi) = \Delta T \Delta E = \frac{L_P}{L_P} = 1. \quad (163)$$

$$\Delta X' \Delta T' = 0 \times \infty = \Delta X \Delta T (\cosh^2 \xi - \sinh^2 \xi) = \Delta X \Delta T = (L_P)^2. \quad (164)$$

$$\Delta P' \Delta E' = \infty \times 0 = \Delta P \Delta E (\cosh^2 \xi - \sinh^2 \xi) = \Delta P \Delta E = \frac{1}{L_P^2}. \quad (165)$$

It is important to emphasize that the invariance property of the minimal Planck-scale *Areas* (maximal Tension) is *not* an exclusive property of *infinite* acceleration boosts  $\xi = \infty$ , but, as a result of the identity  $\cosh^2 \xi - \sinh^2 \xi = 1$ , for all values of  $\xi$ , the minimal Planck-scale *Areas* are *always* invariant under *any* acceleration-boosts transformations. Meaning physically, in units of  $\hbar = c = 1$ , that the Maximal Tension (or maximal Force)  $b = \frac{1}{L_P}$  is a true physical *invariant* universal quantity. Also we notice that the Phase-space areas, or cells, in units of  $\hbar$ , are also invariant ! The pure-acceleration boosts transformations are " symplectic ". It can be shown also that areas greater ( smaller ) than the Planck-area remain greater ( smaller ) than the invariant Planck-area under acceleration-boosts transformations.

The infinite acceleration-boosts are closely related to the infinite red-shift effects when light signals barely escape Black hole Horizons reaching an asymptotic observer with an infinite redshift factor. The important fact is that the Planck-scale *Areas* are truly maintained invariant under acceleration-boosts. This could reveal very important information about Black-holes Entropy and Holography. The logarithmic corrections to the Black-Hole Area-Entropy relation were obtained directly from Clifford-algebraic methods in C-spaces [21], in addition to the derivation of the maximal Planck temperature condition and the Schwarzschild radius in terms of the Thermodynamics of a gas of p-loop-oscillators quanta represented by area-bits, volume-bits, ... hyper-volume-bits in Planck scale units. Minimal loop-areas, in Planck units, is also one of the most important consequences found in Loop Quantum Gravity long ago [111].

## 7 Some Further Important Physical Applications Related to the C-Space Physics

### 7.1 Relativity of signature

In previous sections we have seen how Clifford algebra can be used in the formulation of the point particle classical and quantum theory. The metric of spacetime was assumed, as usually, to have the Minkowski signature, and we have used the choice (+ - - -). There were arguments in the literature of why the spacetime signature is of the Minkowski type [113, 43]. But there are also studies in which signature changes are admitted [112]. It has been found out [16, 15, 30] that within Clifford algebra the signature of the underlying space is a matter of choice of basis vectors amongst available Clifford numbers. We are now going to review those important topics.

Suppose we have a 4-dimensional space  $V_4$  with signature  $(+ + + +)$ . Let  $e_\mu$ ,  $\mu = 0, 1, 2, 3$ , be basis vectors satisfying

$$e_\mu \cdot e_\nu \equiv \frac{1}{2}(e_\mu e_\nu + e_\nu e_\mu) = \delta_{\mu\nu} , \quad (166)$$

where  $\delta_{\mu\nu}$  is the *Euclidean signature* of  $V_4$ . The vectors  $e_\mu$  can be used as generators of Clifford algebra  $\mathcal{C}_4$  over  $V_4$  with a generic Clifford number (also called polyvector or Clifford aggregate) expanded in term of  $e_J = (1, e_\mu, e_{\mu\nu}, e_{\mu\nu\alpha}, e_{\mu\nu\alpha\beta})$ ,  $\mu < \nu < \alpha < \beta$ ,

$$A = a^J e_J = a + a^\mu e_\mu + a^{\mu\nu} e_\mu e_\nu + a^{\mu\nu\alpha} e_\mu e_\nu e_\alpha + a^{\mu\nu\alpha\beta} e_\mu e_\nu e_\alpha e_\beta. \quad (167)$$

Let us consider the set of four Clifford numbers  $(e_0, e_i e_0)$ ,  $i = 1, 2, 3$ , and denote them as

$$\begin{aligned} e_0 &\equiv \gamma_0, \\ e_i e_0 &\equiv \gamma_i. \end{aligned} \quad (168)$$

The Clifford numbers  $\gamma_\mu$ ,  $\mu = 0, 1, 2, 3$ , satisfy

$$\frac{1}{2}(\gamma_\mu \gamma_\nu + \gamma_\nu \gamma_\mu) = \eta_{\mu\nu} , \quad (169)$$

where  $\eta_{\mu\nu} = \text{diag}(1, -1, -1, -1)$  is the *Minkowski tensor*. We see that the  $\gamma_\mu$  behave as basis vectors in a 4-dimensional space  $V_{1,3}$  with signature  $(+ - - -)$ . We can form a Clifford aggregate

$$\alpha = \alpha^\mu \gamma_\mu \quad (170)$$

which has the properties of a *vector* in  $V_{1,3}$ . From the point of view of the space  $V_4$  the same object  $\alpha$  is a linear combination of a vector and bivector:

$$\alpha = \alpha^0 e_0 + \alpha^i e_i e_0. \quad (171)$$

We may use  $\gamma_\mu$  as generators of the Clifford algebra  $\mathcal{C}_{1,3}$  defined over the pseudo-Euclidean space  $V_{1,3}$ . The basis elements of  $\mathcal{C}_{1,3}$  are  $\gamma_J = (1, \gamma_\mu, \gamma_{\mu\nu}, \gamma_{\mu\nu\alpha}, \gamma_{\mu\nu\alpha\beta})$ , with  $\mu < \nu < \alpha < \beta$ . A generic Clifford aggregate in  $\mathcal{C}_{1,3}$  is given by

$$B = b^J \gamma_J = b + b^\mu \gamma_\mu + b^{\mu\nu} \gamma_\mu \gamma_\nu + b^{\mu\nu\alpha} \gamma_\mu \gamma_\nu \gamma_\alpha + b^{\mu\nu\alpha\beta} \gamma_\mu \gamma_\nu \gamma_\alpha \gamma_\beta. \quad (172)$$

With suitable choice of the coefficients  $b^J = (b, b^\mu, b^{\mu\nu}, b^{\mu\nu\alpha}, b^{\mu\nu\alpha\beta})$  we have that  $B$  of eq. (172) is equal to  $A$  of eq.(167). Thus the same number  $A$  can be described either with  $e_\mu$  which generate  $\mathcal{C}_4$ , or with  $\gamma_\mu$  which generate  $\mathcal{C}_{1,3}$ . The expansions (172) and (167) exhaust all possible numbers of the Clifford algebras  $\mathcal{C}_{1,3}$  and  $\mathcal{C}_4$ . Those expansions are just two different representations of the same set of Clifford numbers (also being called polyvectors or Clifford aggregates).

As an alternative to (168) we can choose

$$\begin{aligned} e_0 e_3 &\equiv \tilde{\gamma}_0, \\ e_i &\equiv \tilde{\gamma}_i, \end{aligned} \quad (173)$$

from which we have

$$\frac{1}{2}(\tilde{\gamma}_\mu \tilde{\gamma}_\nu + \tilde{\gamma}_\nu \tilde{\gamma}_\mu) = \tilde{\eta}_{\mu\nu} \quad (174)$$

with  $\tilde{\eta}_{\mu\nu} = \text{diag}(-1, 1, 1, 1)$ . Obviously  $\tilde{\gamma}_\mu$  are basis vectors of a pseudo-Euclidean space  $\tilde{V}_{1,3}$  and they generate the Clifford algebra over  $\tilde{V}_{1,3}$  which is yet another representation of the same set of objects (i.e., polyvectors). The spaces  $V_4$ ,  $V_{1,3}$  and  $\tilde{V}_{1,3}$  are different slices through  $C$ -space, and they span different subsets of polyvectors. In a similar way we can obtain spaces with signatures  $(+ - ++)$ ,  $(+ + -+)$ ,  $(+ + +-)$ ,  $(- + --)$ ,  $(- - +-)$ ,  $(- - -+)$  and corresponding higher dimensional analogs. But we cannot obtain signatures of the type  $(+ + --)$ ,  $(+ - +-)$ , etc. In order to obtain such signatures we proceed as follows.

*4-space.* First we observe that the bivector  $\bar{I} = e_3 e_4$  satisfies  $\bar{I}^2 = -1$ , commutes with  $e_1$ ,  $e_2$  and anticommutes with  $e_3$ ,  $e_4$ . So we obtain that the set of Clifford numbers  $\gamma_\mu = (e_1 \bar{I}, e_2 \bar{I}, e_3, e_4)$  satisfies

$$\gamma_\mu \cdot \gamma_\nu = \bar{\eta}_{\mu\nu} , \quad (175)$$

where  $\bar{\eta} = \text{diag}(-1, -1, 1, 1)$ .

*8-space.* Let  $e_A$  be basis vectors of 8-dimensional vector space with signature  $(+ + + + + +)$ . Let us decompose

$$\begin{aligned} e_A &= (e_\mu, e_{\bar{\mu}}) , & \mu &= 0, 1, 2, 3, \\ & & \bar{\mu} &= \bar{0}, \bar{1}, \bar{2}, \bar{3}. \end{aligned} \quad (176)$$

The inner product of two basis vectors

$$e_A \cdot e_B = \delta_{AB} , \quad (177)$$

then splits into the following set of equations:

$$\begin{aligned} e_\mu \cdot e_\nu &= \delta_{\mu\nu} , \\ e_{\bar{\mu}} \cdot e_{\bar{\nu}} &= \delta_{\bar{\mu}\bar{\nu}} , \\ e_\mu \cdot e_{\bar{\nu}} &= 0. \end{aligned} \quad (178)$$

The number  $\bar{I} = e_{\bar{0}} e_{\bar{1}} e_{\bar{2}} e_{\bar{3}}$  has the properties

$$\begin{aligned} \bar{I}^2 &= 1, \\ \bar{I} e_\mu &= e_\mu \bar{I}, \\ \bar{I} e_{\bar{\mu}} &= -e_{\bar{\mu}} \bar{I}. \end{aligned} \quad (179)$$

The set of numbers

$$\begin{aligned} \gamma_\mu &= e_\mu , \\ \gamma_{\bar{\mu}} &= e_{\bar{\mu}} \bar{I} \end{aligned} \quad (180)$$

satisfies

$$\begin{aligned} \gamma_\mu \cdot \gamma_\nu &= \delta_{\mu\nu} , \\ \gamma_{\bar{\mu}} \cdot \gamma_{\bar{\nu}} &= -\delta_{\bar{\mu}\bar{\nu}} , \\ \gamma_\mu \cdot \gamma_{\bar{\mu}} &= 0. \end{aligned} \quad (181)$$

The numbers  $(\gamma_\mu, \gamma_{\bar{\mu}})$  thus form a set of basis vectors of a vector space  $V_{4,4}$  with signature  $(++++----)$ .

*10-space.* Let  $e_A = (e_\mu, e_{\bar{\mu}})$ ,  $\mu = 1, 2, 3, 4, 5$ ;  $\bar{\mu} = \bar{1}, \bar{2}, \bar{3}, \bar{4}, \bar{5}$  be basis vectors of a 10-dimensional Euclidean space  $V_{10}$  with signature  $(++++\dots)$ . We introduce  $\bar{I} = e_{\bar{1}}e_{\bar{2}}e_{\bar{3}}e_{\bar{4}}e_{\bar{5}}$  which satisfies

$$\begin{aligned}\bar{I}^2 &= 1, \\ e_\mu \bar{I} &= -\bar{I} e_\mu, \\ e_{\bar{\mu}} \bar{I} &= \bar{I} e_{\bar{\mu}}.\end{aligned}\tag{182}$$

Then the Clifford numbers

$$\begin{aligned}\gamma_\mu &= e_\mu \bar{I}, \\ \gamma_{\bar{\mu}} &= e_{\bar{\mu}}\end{aligned}\tag{183}$$

satisfy

$$\begin{aligned}\gamma_\mu \cdot \gamma_\nu &= -\delta_{\mu\nu}, \\ \gamma_{\bar{\mu}} \cdot \gamma_{\bar{\nu}} &= \delta_{\bar{\mu}\bar{\nu}}, \\ \gamma_\mu \cdot \gamma_{\bar{\mu}} &= 0.\end{aligned}\tag{184}$$

The set  $\gamma_A = (\gamma_\mu, \gamma_{\bar{\mu}})$  therefore spans the vector space of signature  $(-----++++)$ .

The examples above demonstrate how vector spaces of various signatures are obtained within a given set of polyvectors. Namely, vector spaces of different signature are different subsets of polyvectors within the same Clifford algebra. In other words, vector spaces of different signature are different subspaces of  $C$ -space, i.e., different sections through  $C$ -space<sup>7</sup>.

This has important physical implications. We have argued that physical quantities are polyvectors (Clifford numbers or Clifford aggregates). Physical space is then not simply a vector space (e.g., Minkowski space), but a space of polyvectors, called  $C$ -space, a pandimensional continuum of points, lines, planes, volumes, etc., altogether. Minkowski space is then just a subspace with pseudo-Euclidean signature. Other subspaces with other signatures also exist within the pandimensional continuum  $C$  and they all have physical significance. If we describe a particle as moving in Minkowski spacetime  $V_{1,3}$  we consider only certain physical aspects of the object considered. We have omitted its other physical properties like spin, charge, magnetic moment, etc.. We can as well describe the same object as moving in an Euclidean space  $V_4$ . Again such a description would reflect only a part of the underlying physical situation described by Clifford algebra.

---

<sup>7</sup>What we consider here should not be confused with the well known fact that Clifford algebras associated with vector spaces of different signatures  $(p, q)$ , with  $p + q = n$ , are not all isomorphic.

## 7.2 Clifford space and the conformal group

### 7.2.1 Line element in $C$ -space of Minkowski spacetime

In 4-dimensional spacetime a polyvector and its square (1) can be written as

$$dX = d\sigma + dx^\mu \gamma_\mu + \frac{1}{2} dx^{\mu\nu} \gamma_\mu \wedge \gamma_\nu + d\tilde{x}^\mu I \gamma_\mu + d\tilde{\sigma} I \quad (185)$$

$$|dX|^2 = d\sigma^2 + dx^\mu dx_\mu + \frac{1}{2} dx^{\mu\nu} dx_{\mu\nu} - d\tilde{x}^\mu d\tilde{x}_\mu - d\tilde{\sigma}^2 \quad (186)$$

The minus sign in the last two terms of the above quadratic form occurs because in 4-dimensional spacetime with signature  $(+---)$  we have  $I^2 = (\gamma_0 \gamma_1 \gamma_2 \gamma_3)(\gamma_0 \gamma_1 \gamma_2 \gamma_3) = -1$ , and  $I^\dagger I = (\gamma_3 \gamma_2 \gamma_1 \gamma_0)(\gamma_0 \gamma_1 \gamma_2 \gamma_3) = -1$ .

In eq.(186) the line element  $dx^\mu dx_\mu$  of the ordinary special or general relativity is replaced by the line element in Clifford space. A “square root” of such a generalized line element is  $dX$  of eq.(185). The latter object is a *polyvector*, a differential of the coordinate polyvector field

$$X = \sigma + x^\mu \gamma_\mu + \frac{1}{2} x^{\mu\nu} \gamma_\mu \wedge \gamma_\nu + \tilde{x}^\mu I \gamma_\mu + \tilde{\sigma} I \quad (187)$$

whose square is

$$|X|^2 = \sigma^2 + x^\mu x_\mu + \frac{1}{2} x^{\mu\nu} x_{\mu\nu} - \tilde{x}^\mu \tilde{x}_\mu - \tilde{\sigma}^2 \quad (188)$$

The polyvector  $X$  contains not only the vector part  $x^\mu \gamma_\mu$ , but also a *scalar part*  $\sigma$ , *tensor part*  $x^{\mu\nu} \gamma_\mu \wedge \gamma_\nu$ , *pseudovector part*  $\tilde{x}^\mu I \gamma_\mu$  and pseudoscalar part  $\tilde{\sigma} I$ . Similarly for the differential  $dX$ .

When calculating the quadratic forms  $|X|^2$  and  $|dX|^2$  one obtains in 4-dimensional spacetime with pseudo euclidean signature  $(+---)$  the minus sign in front of the squares of the pseudovector and pseudoscalar terms. This is so, because in such a case the pseudoscalar unit square in flat spacetime is  $I^2 = I^\dagger I = -1$ . In 4-dimensions  $I^\dagger = I$  regardless of the signature.

Instead of Lorentz transformations—pseudo rotations in spacetime—which preserve  $x^\mu x_\mu$  and  $dx^\mu dx_\mu$  we have now more general rotations—rotations in  $C$ -space—which preserve  $|X|^2$  and  $|dX|^2$ .

### 7.2.2 $C$ -space and conformal transformations

From (186) and (188) we see [25] that a subgroup of the Clifford Group, or rotations in  $C$ -space is the group  $SO(4,2)$ . The transformations of the latter group rotate  $x^\mu$ ,  $\sigma$ ,  $\tilde{\sigma}$ , but leave  $x^{\mu\nu}$  and  $\tilde{x}^\mu$  unchanged. Although according to our assumption physics takes place in full  $C$ -space, it is very instructive to consider a subspace of  $C$ -space, that we shall call *conformal space* whose isometry group is  $SO(4,2)$ .

Coordinates can be given arbitrary symbols. Let us now use the symbol  $\eta^\mu$  instead of  $x^\mu$ , and  $\eta^5, \eta^6$  instead of  $\tilde{\sigma}, \sigma$ . In other words, instead of  $(x^\mu, \tilde{\sigma}, \sigma)$  we write  $(\eta^\mu, \eta^5, \eta^6) \equiv \eta^a$ ,  $\mu = 0, 1, 2, 3$ ,  $a = 0, 1, 2, 3, 5, 6$ . The quadratic form reads

$$\eta^a \eta_a = g_{ab} \eta^a \eta^b \quad (189)$$

with

$$g_{ab} = \text{diag}(1, -1, -1, -1, -1, 1) \quad (190)$$

being the diagonal metric of the flat 6-dimensional space, a subspace of  $C$ -space, parametrized by coordinates  $\eta^a$ . The transformations which preserve the quadratic form (189) belong to the group  $\text{SO}(4,2)$ . It is well known [38, 39] that the latter group, when taken on the cone

$$\eta^a \eta_a = 0 \quad (191)$$

is isomorphic to the 15-parameter group of conformal transformations in 4-dimensional spacetime [40].

Let us consider first the rotations of  $\eta^5$  and  $\eta^6$  which leave coordinates  $\eta^\mu$  unchanged. The transformations that leave  $-(\eta^5)^2 + (\eta^6)^2$  invariant are

$$\begin{aligned} \eta'^5 &= \eta^5 \cosh \alpha + \eta^6 \sinh \alpha \\ \eta'^6 &= \eta^5 \sinh \alpha + \eta^6 \cosh \alpha \end{aligned} \quad (192)$$

where  $\alpha$  is a parameter of such pseudo rotations.

Instead of the coordinates  $\eta^5, \eta^6$  we can introduce [38, 39] new coordinates  $\kappa, \lambda$  according to

$$\kappa = \eta^5 - \eta^6 \quad (193)$$

$$\lambda = \eta^5 + \eta^6 \quad (194)$$

In the new coordinates the quadratic form (189) reads

$$\eta^a \eta_a = \eta^\mu \eta_\mu - (\eta^5)^2 - (\eta^6)^2 = \eta^\mu \eta_\mu - \kappa \lambda \quad (195)$$

The transformation (192) becomes

$$\kappa' = \rho^{-1} \kappa \quad (196)$$

$$\lambda' = \rho \lambda \quad (197)$$

where  $\rho = e^\alpha$ . This is just a dilation of  $\kappa$  and the inverse dilation of  $\lambda$ .

Let us now introduce new coordinates  $x^\mu$  according  $x^\mu$  to<sup>8</sup>

$$\eta^\mu = \kappa x^\mu \quad (198)$$

Under the transformation (198) we have

$$\eta'^\mu = \eta^\mu \quad (199)$$

but

$$x'^\mu = \rho x^\mu \quad (200)$$

The latter transformation is *dilatation* of coordinates  $x^\mu$ .

---

<sup>8</sup>These new coordinates  $x^\mu$  should not be confused with coordinate  $x^\mu$  used in Sec.2.



Considering now a line element

$$d\eta^a d\eta_a = d\eta^\mu d\eta_\mu - d\kappa d\lambda \quad (201)$$

we find that *on the cone*  $\eta^a \eta_a = 0$  it is

$$d\eta^a d\eta_a = \kappa^2 dx^\mu dx_\mu \quad (202)$$

even if  $\kappa$  is not constant. Under the transformation (196) we have

$$d\eta'^a d\eta'_a = d\eta^a d\eta_a \quad (203)$$

$$dx'^\mu dx'_\mu = \rho^2 dx^\mu dx_\mu \quad (204)$$

The last relation is a *dilatation* of the 4-dimensional line element related to coordinates  $x^\mu$ . In a similar way also other transformations of the group SO(4,2) that preserve (191) and (203) we can rewrite in terms of the coordinates  $x^\mu$ . So we obtain—besides dilations—translations, Lorentz transformations, and special conformal transformations; altogether they are called *conformal transformations*. This is a well known old observation [38, 39] and we shall not discuss it further. What we wanted to point out here is that conformal group SO(4,2) is a subgroup of the Clifford group.

### 7.2.3 On the physical interpretation of the conformal group SO(4,2)

In order to understand the physical meaning of the transformations (198) from the coordinates  $\eta^\mu$  to the coordinates  $x^\mu$  let us consider the following transformation in 6-dimensional space  $V_6$ :

$$\begin{aligned} x^\mu &= \kappa^{-1} \eta^\mu \\ \alpha &= -\kappa^{-1} \\ \Lambda &= \lambda - \kappa^{-1} \eta^\mu \eta_\mu \end{aligned} \quad (205)$$

This is a transformation from the coordinates  $\eta^a = (\eta^\mu, \kappa, \lambda)$  to the new coordinates  $x^a = (x^\mu, \alpha, \Lambda)$ . No extra condition on coordinates, such as (191), is assumed now. If we calculate the line element in the coordinates  $\eta^a$  and  $x^a$ , respectively, we find the the following relation [27]

$$d\eta^\mu d\eta^\nu g_{\mu\nu} - d\kappa d\lambda = \alpha^{-2} (dx^\mu dx^\nu g_{\mu\nu} - d\alpha d\Lambda) \quad (206)$$

We can interpret a transformation of coordinates *passively* or *actively*. Geometric calculus clarifies significantly the meaning of passive and active transformations. Under a *passive transformation* a vector remains the same, but its components and basis vector change. For a vector  $d\eta = d\eta^a \gamma_a$  we have

$$d\eta' = d\eta'^a \gamma'_a = d\eta^a \gamma_a = d\eta \quad (207)$$

with

$$d\eta'^a = \frac{\partial \eta'^a}{\partial \eta^b} d\eta^b \quad (208)$$

and

$$\gamma'_a = \frac{\partial \eta^b}{\partial \eta'^a} \gamma_b \quad (209)$$

Since the vector is invariant, so is its square:

$$d\eta'^2 = d\eta'^a \gamma'_a d\eta'^b \gamma'_b = d\eta'^a d\eta'^b g'_{ab} = d\eta^a d\eta^b g_{ab} \quad (210)$$

From (209) we read that the well known relation between new and old coordinates:

$$g'_{ab} = \frac{\partial \eta^c}{\partial \eta'^a} \frac{\partial \eta^d}{\partial \eta'^b} g_{cd} \quad (211)$$

Under an *active transformation* a vector changes. This means that in a fixed basis the components of a vector change:

$$d\eta' = d\eta'^a \gamma_a \quad (212)$$

with

$$d\eta'^a = \frac{\partial \eta'^a}{\partial \eta^b} d\eta^b \quad (213)$$

The transformed vector  $d\eta'$  is different from the original vector  $d\eta = d\eta^a \gamma_a$ . For the square we find

$$d\eta'^2 = d\eta'^a d\eta'^b g_{ab} = \frac{\partial \eta'^a}{\partial \eta^c} \frac{\partial \eta'^b}{\partial \eta^d} d\eta^c d\eta^d g_{ab} \quad (214)$$

i.e., the transformed line element  $d\eta'^2$  is different from the original line element.

Returning now to the coordinate transformation (205) with the identification  $\eta'^a = x^a$ , we can interpret eq. (206) passively or actively.

In the *passive interpretation* the metric tensor and the components  $d\eta^a$  change under a transformation, so that in our particular case the relation (210) becomes

$$dx^a dx^b g'_{ab} = \alpha^{-2} (dx^\mu dx^\nu g_{\mu\nu} - d\alpha d\Lambda) = d\eta^a d\eta^b g_{ab} = d\eta^\mu d\eta^\nu g_{\mu\nu} - d\kappa d\lambda \quad (215)$$

with

$$g'_{ab} = \alpha^{-2} \begin{pmatrix} g_{\mu\nu} & 0 & 0 \\ 0 & 0 & -\frac{1}{2} \\ 0 & -\frac{1}{2} & 0 \end{pmatrix}, \quad g_{ab} = \begin{pmatrix} g_{\mu\nu} & 0 & 0 \\ 0 & 0 & -\frac{1}{2} \\ 0 & -\frac{1}{2} & 0 \end{pmatrix} \quad (216)$$

In the above equation the same infinitesimal distance squared is expressed in two different coordinates  $\eta^a$  or  $x^a$ .

In *active interpretation*, only  $d\eta^a$  change, whilst the metric remains the same, so that the transformed element is

$$dx^a dx^b g_{ab} = dx^\mu dx^\nu g_{\mu\nu} - d\alpha d\Lambda = \kappa^{-2} d\eta^a d\eta^b g_{ab} = \kappa^{-2} (d\eta^\mu d\eta^\nu g_{\mu\nu} - d\kappa d\lambda) \quad (217)$$

The transformed line element  $dx^a dx_a$  is physically different from the original line element  $d\eta^a d\eta_a$  by a factor  $\alpha^2 = \kappa^{-2}$

A rotation (192) in the plane  $(\eta^5, \eta^6)$  (i.e., the transformation (196),(197) of  $(\kappa, \lambda)$ ) manifests in the new coordinates  $x^a$  as a *dilatation* of the line element  $dx^a dx_a = \kappa^{-2} d\eta^a \eta_a$ :

$$dx'^a dx'_a = \rho^2 dx^a dx_a \quad (218)$$

All this is true in the full space  $V_6$ . On the cone  $\eta^a \eta_a = 0$  we have  $\Lambda = \lambda - \kappa \eta^\mu \eta_\mu = 0$ ,  $d\Lambda = 0$  so that  $dx^a dx_a = dx^\mu dx_\mu$  and we reproduce the relations (204) which is a dilatation of the 4-dimensional line element. It can be interpreted either passively or actively. In general, the pseudo rotations in  $V_6$ , that is, the transformations of the 15-parameter group  $SO(4,2)$  when expressed in terms of coordinates  $x^a$ , assume on the cone  $\eta^a \eta_a = 0$  the form of the ordinary conformal transformations. They all can be given the active interpretation [27, 28].

We started from the new paradigm that physical phenomena actually occur not in spacetime, but in a larger space, the so called *Clifford space* or *C-space* which is a manifold associated with the Clifford algebra generated by the basis vectors  $\gamma_\mu$  of spacetime. An arbitrary element of Clifford algebra can be expanded in terms of the objects  $E_A$ ,  $A = 1, 2, \dots, 2^D$ , which include, when  $D = 4$ , the scalar unit  $\mathbf{1}$ , vectors  $\gamma_\mu$ , bivectors  $\gamma_\mu \wedge \gamma_\nu$ , pseudovectors  $I\gamma_\mu$  and the pseudoscalar unit  $I \equiv \gamma_5$ . *C-space* contains 6-dimensional subspace  $V_6$  spanned<sup>9</sup> by  $\mathbf{1}$ ,  $\gamma_\mu$ , and  $\gamma_5$ . The metric of  $V_6$  has the signature  $(+ - - - - +)$ . It is well known that the rotations in  $V_6$ , when taken on the conformal cone  $\eta^a \eta_a = 0$ , are isomorphic to the non linear transformations of the conformal group in spacetime. Thus we have found out that *C-space* contains —as a subspace— the 6-dimensional space  $V_6$  in which the conformal group acts linearly. From the physical point of view this is an important and, as far as we know, a novel finding, although it might look mathematically trivial. *So far it has not been clear what could be a physical interpretation of the 6 dimensional conformal space.* Now we see that it is just a subspace of Clifford space. The two extra dimensions, parametrized by  $\kappa$  and  $\lambda$ , are not the ordinary extra dimensions; they are coordinates of Clifford space  $C_4$  of the 4-dimensional Minkowski spacetime  $V_4$ .

We take *C-space* seriously as an arena in which physics takes place. The theory is a very natural, although not trivial, extension of the special relativity in spacetime. In special relativity the transformations that preserve the quadratic form are given an *active interpretation*: they relate the objects or the systems of reference in *relative translational motion*. Analogously also the transformations that preserve the quadratic form (186) or (188) in *C-space* should be given an active interpretation. We have found that among such transformations (rotations in *C-space*) there exist the transformations of the group  $SO(4,2)$ . Those transformations also should be given an active interpretation as the transformations that relate different physical objects or reference frames. Since in the ordinary relativity we do not impose any constraint on the coordinates of a freely moving object so we should not impose any constraint in *C-space*, or in the subspace  $V_6$ . However, by using the projective coordinate transformation (205), without any constraint such as  $\eta^a \eta_a = 0$ , we arrived at the relation (217) for the line elements. If in the coordinates  $\eta^a$  the line element is constant, then in the coordinates  $x^a$  the line element is changing by a scale factor  $\kappa$  which, in general, depends on the evolution parameter  $\tau$ . The line element need not be one associated between two events along a point particle's worldline: it can

---

<sup>9</sup>It is a well known observation that the generators  $L_{ab}$  of  $SO(4,2)$  can be realized in terms of  $\mathbf{1}$ ,  $\gamma_\mu$ , and  $\gamma_5$ . Lorentz generators are  $M_{\mu\nu} = -\frac{i}{4}[\gamma_\mu, \gamma_\nu]$ , dilatations are generated by  $D = L_{65} = -\frac{1}{2}\gamma_5$ , translations by  $P_\mu = L_{5\mu} + L_{6\mu} = \frac{1}{2}\gamma_\mu(1 - i\gamma_5)$  and the special conformal transformations by  $L_{5\mu} - L_{6\mu} = \frac{1}{2}\gamma_\mu(1 + i\gamma_5)$ . This essentially means that the generators are  $L_{ab} = -\frac{i}{4}[e_a, e_b]$  with  $e_a = (\gamma_\mu, \gamma_5, \mathbf{1})$ , where care must be taken to replace commutators  $[\mathbf{1}, \gamma_5]$  and  $[\mathbf{1}, \gamma_\mu]$  with  $2\gamma_5$  and  $2\gamma_\mu$ .

be between two arbitrary (space-like or time-like) events within an extended object. We may consider the line element ( $\equiv$  distance squared) between two infinitesimally separated events within an extended object such that both events have the same coordinate label  $\Lambda$  so that  $d\Lambda = 0$ . Then the 6-dimensional line element  $dx^\mu dx^\nu g_{\mu\nu} - d\alpha d\Lambda$  becomes the 4-dimensional line element  $dx^\mu dx^\nu g_{\mu\nu}$  and, because of (217) it changes with  $\tau$  when  $\kappa$  does change. This means that the object changes its *size*, it is moving dilatationally [27, 28]. We have thus arrived at a very far reaching observation that the relativity in  $C$ -space implies *scale changes of physical objects as a result of free motion, without presence of any forces or such fields as assumed in Weyl theory*. This was advocated long time ago [27, 28], but without recourse to  $C$ -space. However, if we consider the full Clifford space  $C$  and not only the Minkowski spacetime section through  $C$ , then we arrive at a more general dilatational motion [17] related to the polyvector coordinates  $x^{\mu\nu}$ ,  $x^{\mu\nu\alpha}$  and  $x^{0123} \equiv \tilde{\sigma}$  (also denoted  $s$ ) as reviewed in section 3.

### 7.3 C-space Maxwell Electrodynamics

Finally, in this section we will review and complement the proposal of ref.[75] to generalize Maxwell Electrodynamics to  $C$ -spaces, namely, construct the Clifford algebra-valued extension of the Abelian field strength  $F = dA$  associated with ordinary vectors  $A_\mu$ . Using Clifford algebraic methods we shall describe how to generalize Maxwell's theory of Electrodynamics associated with ordinary point-charges to a generalized Maxwell theory in Clifford spaces involving *extended* charges and p-forms of arbitrary rank, not unlike the couplings of p-branes to antisymmetric tensor fields.

Based on the standard definition of the Abelian field strength  $F = dA$  we shall use the same definition in terms of polyvector-valued quantities and differential operators in  $C$ -space

$$A = A_N E^N = \phi \underline{1} + A_\mu \gamma^\mu + A_{\mu\nu} \gamma^\mu \wedge \gamma^\nu + \dots \quad (219)$$

The first component in the expansion  $\phi$  is a scalar field;  $A_\mu$  is the standard Maxwell field  $A_\mu$ , the third component  $A_{\mu\nu}$  is a rank two antisymmetric tensor field...and the last component of the expansion is a pseudo-scalar. The fact that a scalar and pseudo-scalar field appear very naturally in the expansion of the  $C$ -space polyvector valued field  $A_N$  suggests that one could attempt to identify the latter fields with a dilaton-like and axion-like field, respectively. Once again= , in order to match units in the expansion (219), it requires the introduction of suitable powers of a length scale parameter, the Planck scale which is conveniently set to unity.

The differential operator is the generalized Dirac operator

$$d = E^M \partial_M = \underline{1} \partial_\sigma + \gamma^\mu \partial_{x_\mu} + \gamma^\mu \wedge \gamma^\nu \partial_{x_{\mu\nu}} + \dots \quad (220)$$

the polyvector-valued indices  $M, N, \dots$  range from  $1, 2, \dots, 2^D$  since a Clifford algebra in  $D$ -dim has  $2^D$  basis elements. The generalized Maxwell field strength in  $C$ -space is

$$F = dA = E^M \partial_M (E^N A_N) = E^M E^N \partial_M A_N = \frac{1}{2} \{E^M, E^N\} \partial_M A_N +$$



$$\frac{1}{2}[E^M, E^N]\partial_M A_N = \frac{1}{2}F_{(MN)}\{E^M, E^N\} + \frac{1}{2}F_{[MN]}[E^M, E^N]. \quad (221)$$

where one has *decomposed* the Field strength components into a symmetric plus antisymmetric piece by simply writing the Clifford geometric product of two polyvectors  $E^M E^N$  as the sum of an anticommutator plus a commutator piece respectively,

$$F_{(MN)} = \frac{1}{2}(\partial_M A_N + \partial_N A_M). \quad (222)$$

$$F_{[MN]} = \frac{1}{2}(\partial_M A_N - \partial_N A_M). \quad (223)$$

Let the C-space Maxwell action (up to a numerical factor) be given in terms of the antisymmetric part of the field strength:

$$I[A] = \int [DX] F_{[MN]} F^{[MN]}. \quad (224)$$

where  $[DX]$  is a C-space measure comprised of all the (holographic) coordinates degrees of freedom

$$[DX] \equiv (d\sigma)(dx^0 dx^1 \dots)(dx^{01} dx^{02} \dots) \dots (dx^{012 \dots D}). \quad (225)$$

Action (224) is invariant under the gauge transformations

$$A'_M = A_M + \partial_M \Lambda \quad (226)$$

The matter-field minimal coupling (interaction term) is:

$$\int A_M dX^M = \int [DX] J_M A^M, \quad (227)$$

where one has reabsorbed the coupling constant, the C-space analog of the electric charge, within the expression for the  $A$  field itself. Notice that this term (227) has the same form as the coupling of p-branes (whose world volume is  $p + 1$ -dimensional) to antisymmetric tensor fields of rank  $p + 1$ .

The open line integral in C-space of the matter-field interaction term in the action is taken from the polyparticle's proper time interval  $S$  ranging from  $-\infty$  to  $+\infty$  and can be recast via the Stokes law solely in terms of the antisymmetric part of the field strength. This requires closing off the integration countour by a semi-circle that starts at  $S = +\infty$ , goes all the way to C-space infinity, and comes back to the point  $S = -\infty$ . The field strength vanishes along the points of the semi-circle at infinity, and for this reason the net contribution to the contour integral is given by the open-line integral. Therefore, by rewriting the  $\int A_M dX^M$  via the Stokes law relation, it yields

$$\begin{aligned} \int A_M dX^M &= \int F_{[MN]} dS^{[MN]} = \int F_{[MN]} X^M dX^N = \\ &= \int dS F_{[MN]} X^M (dX^N / dS). \end{aligned} \quad (228)$$

where in order to go from the second term to the third term in the above equation we have integrated by parts and then used the Bianchi identity for the antisymmetric component  $F_{[MN]}$ .

The integration by parts permits us to go from a C-space domain integral, represented by the Clifford-value hypersurface  $S^{MN}$ , to a C-space boundary-line integral

$$\int dS^{MN} = \frac{1}{2} \int (X^M dX^N - X^N dX^M). \quad (229)$$

The pure matter terms in the action are given by the analog of the proper time integral spanned by the motion of a particle in spacetime:

$$\kappa \int dS = \kappa \int dS \sqrt{\frac{dX^M}{dS} \frac{dX_M}{dS}}. \quad (230)$$

where  $\kappa$  is a parameter whose dimensions are  $(mass)^{p+1}$  and  $S$  is the polyparticle proper time in C-space.

The Lorentz force relation in C-space is directly obtained from a variation of

$$\int dS F_{[MN]} X^M (dX^N/dS). \quad (231)$$

and

$$\kappa \int dS = \kappa \int \sqrt{dX^M dX_M}. \quad (232)$$

with respect to the  $X^M$  variables:

$$\kappa \frac{d^2 X_M}{dS^2} = e F_{[MN]} \frac{dX^N}{dS}. \quad (233)$$

where we have re-introduced the C-space charge  $e$  back into the Lorentz force equation in C-space. A variation of the terms in the action w.r.t the  $A_M$  field furnishes the following equation of motion for the  $A$  fields:

$$\partial_M F^{[MN]} = J^N. \quad (234)$$

By taking derivatives on both sides of the last equation with respect to the  $X^N$  coordinate, one obtains due to the symmetry condition of  $\partial_M \partial_N$  versus the antisymmetry of  $F^{[MN]}$  that

$$\partial_N \partial_M F^{[MN]} = 0 = \partial_N J^N = 0. \quad (235)$$

which is precisely the continuity equation for the current.

The continuity equation is essential to ensure that the matter-field coupling term of the action  $\int A_M dX^M = \int [DX] J^M A_M$  is also gauge invariant, which can be readily verified after an integration by parts and setting the boundary terms to zero:

$$\delta \int [DX] J^M A_M = \int [DX] J^M \partial_M \Lambda = - \int [DX] (\partial_M J^M) \Lambda = 0. \quad (236)$$

Gauge invariance also ensures the conservation of the energy-momentum (via Noether's theorem) defined in terms of the Lagrangian density variation. We refer to [75] for further details.

The gauge invariant  $C$ -space Maxwell action as given in eq. (224) is in fact only a part of a more general action given by the expression

$$I[A] = \int [\mathcal{D}X] F^\dagger * F = \int [\mathcal{D}X] \langle F^\dagger F \rangle_{scalar} . \quad (237)$$

This action can also be written in terms of components, up to dimension-dependent *numerical* coefficients, as [75] :

$$I[A] = \int [\mathcal{D}X] (F_{(MN)}F^{(MN)} + F_{[MN]}F^{[MN]}) \quad (238)$$

For rigor, one should introduce the numerical coefficients in front of the  $F$  terms, noticing that the symmetric combination should have a different dimension-dependent coefficient than the anti-symmetric combination since the former involves contractions of  $\{E^M, E^N\} * \{E_M, E_N\}$  and the latter contractions of  $[E^M, E^N] * [E_M, E_N]$  .

The latter action is strictly speaking not gauge invariant, since it contains not only the antisymmetric but also the symmetric part of  $F$ . It is invariant under a *restricted* gauge symmetry transformations. It is invariant ( up to total derivatives) under *infinitesimal* gauge transformations provided the symmetric part of  $F$  is divergence-free  $\partial_M F^{(MN)} = 0$  [75] . This divergence-free condition has the same effects as if one were fixing a gauge leaving a *residual* symmetry of *restricted* gauge transformations such that the gauge symmetry parameter obeys the Laplace-like equation  $\partial_M \partial^M \Lambda = 0$ . Such residual ( restricted ) symmetries are precisely those that leave invariant the divergence-free condition on the symmetric part of  $F$ . Residual, restricted symmetries occur, for example, in the light-cone gauge of p-brane actions leaving a residual symmetry of *volume*-preserving diffs. They also occur in string theory when the conformal gauge is chosen leaving a residual symmetry under conformal reparametrizations; i.e. the so-called Virasoro algebras whose symmetry transformations are given by holomorphic and anti-holomorphic reparametrizations of the string world-sheet.

This Laplace-like condition on the gauge parameter is also the one required such that the action in [75] is invariant under *finite* (restricted) gauge transformations since under such (restricted) finite transformations the Lagrangian changes by second-order terms of the form  $(\partial_M \partial_N \Lambda)^2$ , which are total derivatives if, and only if, the gauge parameter is restricted to obey the analog of Laplace equation  $\partial_M \partial^M \Lambda = 0$

Therefore the action of eq- ( 233 ) is invariant under a *restricted* gauge transformation which bears a resemblance to *volume*-preserving diffeomorphisms of the  $p$ -branes action in the light-cone gauge. A lesson that we have from these considerations is that the  $C$ -space Maxwell action written in the form (237) automatically contains a gauge fixing term. Analogous result for *ordinary* Maxwell field is known from Hestenes work [1], although formulated in a slightly different way, namely by directly considering the field equations without employing the action.

It remains to be seen if this construction of  $C$ -space generalized Maxwell Electrodynamics of  $p$ -forms can be generalized to the Nonabelian case when we replace ordinary derivatives by gauge-covariant ones:

$$F = dA \rightarrow F = DA = (dA + A \bullet A). \quad (239)$$

For example, one could define the graded-symmetric product  $E_M \bullet E_N$  based on the graded commutator of Superalgebras:

$$[A, B] = AB - (-1)^{s_A s_B} BA. \quad (240)$$

$s_A, s_B$  is the grade of  $A$  and  $B$  respectively. For bosons the grade is even and for fermions is odd. In this fashion the graded commutator captures both the anti-commutator of two fermions and the commutator of two bosons in one stroke. One may extend this graded bracket definition to the graded structure present in Clifford algebras, and define

$$E_M \bullet E_N = E_M E_N - (-1)^{s_M s_N} E_N E_M. \quad (241)$$

$s_M, s_N$  is the grade of  $E_M$  and  $E_N$  respectively. Even or odd depending on the grade of the basis elements.

One may generalize Maxwell's theory to Born-Infeld nonlinear Electrodynamics in C-spaces based on this extension of Maxwell Electrodynamics in C-spaces and to couple a C-space version of a Yang-Mills theory to C-space gravity, a higher derivative gravity with torsion, this will be left for a future publication. Clifford algebras have been used in the past [62] to study the Born-Infeld model in ordinary spacetime and to write a nonlinear version of the Dirac equation. The natural incorporation of monopoles in Maxwell's theory was investigated by [89] and a recent critical analysis of "unified" theories of gravity with electromagnetism has been presented by [90]. Most recently [22] has studied the covariance of Maxwell's theory from a Clifford algebraic point of view.

## 8 Concluding Remarks

We have presented a brief review of some of the most important features of the Extended Relativity theory in Clifford-spaces (C-spaces). The "coordinates"  $X$  are noncommuting Clifford-valued quantities which incorporate the lines, areas, volumes,....degrees of freedom associated with the collective particle, string, membrane,... dynamics underlying the center-of-mass motion and holographic projections of the  $p$ -loops onto the embedding target spacetime backgrounds. C-space Relativity incorporates the idea of an invariant length, which upon quantization, should lead to the notion of minimal Planck scale [23]. Other relevant features are those of maximal acceleration [52], [49]; the invariance of Planck-areas under acceleration boosts; the resolution of ordering ambiguities in QFT; supersymmetry; holography [119]; the emergence of higher derivative gravity with torsion; and the inclusion of variable dimensions/signatures that allows to study the dynamics of all (closed)  $p$ -branes, for all values of  $p$ , in one single unified footing, by starting with the C-space brane action constructed in this work.

The Conformal group construction presented in 7, as a natural subgroup of the Clifford group in four-dimensions, needs to be generalized to other dimensions, in particular to two dimensions where the Conformal group is infinite-dimensional. Kinani [130] has shown that the Virasoro algebra can be obtained from generalized Clifford algebras. The construction of area-preserving diffeomorphism algebras, like  $w_\infty$  and  $su(\infty)$ , from Clifford algebras remains an open problem. Area-preserving diffeomorphism algebras are very important in the study



of membranes and gravity since Higher-dim Gravity in  $m + n$ -dim has been shown a while ago to be equivalent to a lower  $m$ -dim Yang-Mills-like gauge theory of diffeomorphisms of an internal  $n$ -dim space [120] and that amounts to another explanation of the holographic principle behind the *AdS/CFT* duality conjecture [121]. We have shown how C-space Relativity involves scale changes in the sizes of physical objects, in the absence of forces and Weyl-gauge field of dilations. The introduction of scale-motion degrees of freedom has recently been implemented in the wavelet-based regularization procedure of QFT by [87]. The connection to Penrose's Twistor's program is another interesting project worthy of investigation.

The quantization and construction of QFTs in C-spaces remains a very daunting task since it may involve the construction of QM in Noncommutative spacetimes [136], braided Hopf quantum Clifford algebras [86], hypercomplex extensions of QM like quaternionic and octonionic QM [99], [97], [98], exceptional group extensions of the Standard Model [85], hyper-matrices and hyper-determinants [88], multi-symplectic mechanics, the de Donde-Weyl formulations of QFT [82], to cite a few, for example. The quantization program in C-spaces should share similar results as those in Loop Quantum Gravity [111], in particular the minimal Planck areas of the expectation values of the area-operator.

Spacetime at the Planck scale may be discrete, fractal, fuzzy, noncommutative... The original Scale Relativity theory in fractal spacetime [23] needs to be extended further to incorporate the notion of fractal "manifolds". A scale-fractal calculus and a fractal-analysis construction that are essential in building the notion of a fractal "manifold" has been initiated in the past years by [129]. It remains yet to be proven that a scale-fractal calculus in fractal spacetimes is another realization of a Connes Noncommutative Geometry. Fractal strings/branes and their spectrum have been studied by [104] that may require generalized Statistics beyond the Boltzmann-Gibbs, Bose-Einstein and Fermi-Dirac, investigated by [105], [103], among others.

Non-Archimedean geometry has been recognized long ago as the natural one operating at the minimal Planck scale and requires the use p-adic numbers instead of ordinary numbers [101]. By implementing the small/large scale, ultraviolet/infrared duality principle associated with QFTs in Noncommutative spaces, see [125] for a review, one would expect an upper maximum scale [23] and a maximum temperature [21] to be operating in Nature. Non-Archimedean Cosmologies based on an upper scale has been investigated by [94].

An upper/lower scale can be accommodated simultaneously and very naturally in the q-Gravity theory of [114], [69] based on bicovariant quantum group extensions of the Poincare, Conformal group, where the  $q$  deformation parameter could be equated to the quantity  $e^{\Lambda/L}$ , such that both  $\Lambda = 0$  and  $L = \infty$ , yield the same classical  $q = 1$  limit. For a review of q-deformations of Clifford algebras and their generalizations see [86], [128].

It was advocated long ago by Wheeler and others, that information theory [106], set theory and number theory, may be the ultimate physical theory. The important role of Clifford algebras in information theory have been known for some time [95]. Wheeler's spacetime foam at the Planck scale may be the background source generation of Noise in the Parisi-Wu stochastic quantization [47] that is very relevant in Number theory [100]. The pre-geometry cellular-networks approach of [107] and the quantum-topos views based

on gravitational quantum causal sets, noncommutative topology and category theory [109], [110], [124] deserves a further study within the C-space Relativity framework, since the latter theory also invokes a Category point of view to the notion of dimensions. C-space is a pandimensional continuum [14], [8]. Dimensions are topological invariants and, since the dimensions of the extended objects change in C-space, topology-change is another ingredient that needs to be addressed in C-space Relativity and which may shed some light into the physical foundations of string/M theory [118]. It has been speculated that the universal symmetries of string theory [108] may be linked to Borchers Vertex operator algebras (the Monstrous moonshine) that underline the deep interplay between Conformal Field Theories and Number theory. A lot remains to be done to bridge together these numerous branches of physics and mathematics. Many surprises may lie ahead of us. For a most recent discussion on the path towards a Clifford-Geometric Unified Field theory of all forces see [138], [140]. The notion of a Generalized Supersymmetry in Clifford Superspaces as extensions of  $M, F$  theory algebras was recently advanced in [139]

#### Acknowledgements

We are indebted to M. Bowers and C. Handy at the CTSPS ( Atlanta ) for support . The work of M. P. has been supported by the Ministry of Education, Science and Sport of Slovenia.

## References

- [1] D. Hestenes, "Spacetime Algebra" Gordon and Breach, New York, 1996.  
D. Hestenes and G. Sobczyk, "Clifford Algebra to Geometric Calculus" D. Reidel Publishing Company, Dordrecht, 1984.
- [2] I. R. Porteous, Clifford Algebras and the Classical Groups, Cambridge University Press, 1995.
- [3] W. Baylis, Electrodynamics, A Modern Geometric Approach, Boston, Birkhauser, 1999.
- [4] G. Trayling and W. Baylis, J.Phys. A34 (2001) 3309-3324; Int.J.Mod.Phys. A16S1C (2001) 909-912.
- [5] B. Jancewicz, Multivectors and Clifford Algebra in Electrodynamics World Scientific, Singapore 1989.
- [6] "Clifford Algebras and their applications in Mathematical Physics Vol 1: Algebras and Physics. eds by R. Ablamowicz, B. Fauser. Vol 2: Clifford analysis. eds by J. Ryan, W. Sprosig Birkhauser, Boston 2000.
- [7] P. Lounesto, "Clifford Algebras and Spinors". Cambridge University Press. 1997.
- [8] C. Castro, Chaos, Solitons and Fractals **10** (1999) 295. Chaos, Solitons and Fractals **12** (2001) 1585. " The Search for the Origins of M Theory: Loop Quantum Mechanics, Loops/Strings and Bulk/Boundary Dualities " [arXiv: hep-th/9809102].

- [9] C. Castro *The Programs of the Extended Relativity in C-spaces, towards physical foundations of String Theory*, Advance NATO Workshop on the Nature of Time, Geometry and the Physics of Perception, Tatranksa Lomnica, Slovakia, May 2001. Kluwer Publishers 2003.
- [10] C. Castro, *Chaos, Solitons and Fractals* **11** (2000) 1663. *Foundations of Physics* **30** (2000) 1301.
- [11] D. Amati, M. Ciafaloni and G. Veneziano, *Phys. Letts* **B 197** (1987) 81. D. Gross, P. Mende, *Phys. Letts* **B 197** (1987) 129. M. Maggiore, *Phys. Lett* **B 304** (1993) 65.
- [12] S. Ansoldi, C. Castro and E. Spalluci, *Class. Quant. Grav* **18** (1999) 1833. C. Castro, *Chaos, Solitons and Fractals* **11** (2000) 1721
- [13] Y. Hosotani, *Phys. Rev. Lett* **55** (1985) 1719. L. Carson, C.H. Ho and Y. Hosotani, *Phys. Rev.* **D 37** (1988) 1519. C.H. Ho, *Jour. Math. Phys* **30** (1989) 2168.
- [14] W. Pezzaglia, “Physical Applications of a Generalized Geometric Calculus” [arXiv: gr-qc/9710027]. Dimensionally Democratic calculus and Principles of Polydimensional Physics [arXiv: gr-qc/9912025]. Classification of Multivector Theories and Modifications of the Postulates of Physics [arXiv: gr-qc/9306006] ; Physical Applications of Generalized Clifford Calculus: Papatetrou equations and Metamorphic Curvature [arXiv: gr-qc/9710027]. Classification of Multivector theories and modification of the postulates of Physics [arXiv: gr-qc/9306006].
- [15] M. Pavšič: “The Landscape of Theoretical Physics: A Global View; From Point Particle to the Brane World and Beyond, in Search of Unifying Principle”, Kluwer Academic, Dordrecht 2001.
- [16] M. Pavšič, *Foundations of Physics* **31** (2001) 1185.
- [17] M. Pavšič, *Foundations of Physics* **33** (2003) 1277 gr-qc/0211085.
- [18] S. Ansoldi, A. Aurilia, C. Castro, E. Spallucci, *Phys. Rev.* **D 64** 026003 (2001)
- [19] A. Aurilia, S. Ansoldi and E. Spallucci, *Class. Quant. Grav.* **19** (2002) 3207 [arXiv:hep-th/0205028].
- [20] C. Castro, M. Pavšič, *Phys. Letts.* **B 539** (2002) 133.
- [21] C. Castro, *Jour. of Entropy* **3** (2001) 12-26. C. Castro and Alex Granik, *Foundations of Physics* **33** (3) (2003) 445.
- [22] T. Ivezic, *Foundations of Physics Lett* **15** (2002) 27. Invariant Relativistic Electrodynamics, Clifford Algebra Approach arXiv: hep-th/0207250].

- [23] L. Nottale: *Fractal Spacetime and Microphysics, towards the Theory of Scale Relativity*, World Scientific 1992. *La Relativité dans tous ses états*, Hachette Literature, Paris,
- [24] S. Ansoldi, A. Aurilia and E. Spallucci, *Phys. Rev D* **56** no. 4 (1997) 2352. *Chaos, Solitons and Fractals* **10** (1999) 197.
- [25] C. Castro and M. Pavšič, *Int. J. Theor. Phys.* **42** (2003) 1693.
- [26] M. Pavšič, *Class. Quant. Grav.* **20** (2003) 2697 [arXiv:gr-qc/0111092].
- [27] M. Pavšič, *Nuovo Cim. B* **41** (1977) 397; *International Journal of Theoretical Physics* **14**, 299 (1975)
- [28] M. Pavšič, *J. Phys. A* **13** (1980) 1367.
- [29] M. Pavšič, *Found. Phys.* **26** (1996) 159 [arXiv:gr-qc/9506057].
- [30] M. Pavšič, arXiv:gr-qc/0210060.
- [31] J. P. Terletsky, *Doklady Akadm. Nauk SSSR*, **133**, 329 (1960); M. P. Bilaniuk, V. K. Deshpande and E.C. G. Sudarshan, *American Journal of Physics* **30**, 718 (1962); E. Recami and R. Mignani, *Rivista del Nuovo Cimento* **4**, 209 (1974); E. Recami, *Rivista del Nuovo Cimento* **9**, 1 (1986)
- [32] M. Pavšič, *J. Phys. A* **14** (1981) 3217.
- [33] E.C.G. Stueckelberg, *Helv. Phys. Acta*, **14**, 322 (1941); **14**, 588 (1941); **15**, 23 (1942)
- [34] L.P. Horwitz and C. Piron, *Helv. Phys. Acta*, **46**, 316 (1973); L.P. Horwitz and F. Rohrlich, *Physical Review D* **24**, 1528 (1981); **26**, 3452 (1982); L.P. Horwitz, R.I. Arshansky and A.C. Elitzur *Found. Phys* **18**, 1159 (1988); R.I. Arshansky, L.P. Horwitz and Y. Lavie, *Foundations of Physics* **13**, 1167 (1983)
- [35] M. Pavšič, *Found. Phys.* **21**, 1005 (1991); *Nuovo Cim. A* **104**, 1337 (1991); *Doga, Turkish Journ. Phys.* **17**, 768 (1993) *Found. Phys.* **25**, 819 (1995); *Nuovo Cimento A* **108**, 221 (1995); *Foundations of Physics* **26**, 159 (1996); M. Pavšič, *Nuovo Cimento A* **110**, 369 (1997); *Found. Phys.* **28** (1998); 1443. *Found. Phys.* **28** (1998) 1453.
- [36] C.W. Misner, K. S. Thorne and J. A. Wheeler, *Gravitation*, Freeman, San Francisco, 1973), p. 1215
- [37] A. Schild, *Phys.Rev.* **D16**, 1722 (1977)
- [38] H.A. Kastrup, *Annaled der Physik (Lpz.)* **7**, 388 (1962)
- [39] A.O. Barut and R. B. Haugen, *Annals of Physics* **71**, 519 (1972)

- [40] E. Cunningham, Proc. London Math. Soc. **8**, 77 (1909); H. Bateman, Proc. London Math. Soc. **8**, 223 (1910); T. Fulton, F. Rohrlich and L. Witten, Rev. Mod. Phys. **34**, 442 (1962); J. Wess, Nuovo Cim., **18**, 1086 (1960); G. Mack, Nucl. Phys. **B5**, 499 (1968); A.F. Grillo, Riv. Nuovo Cim. **3**, 146 (1973); J. Niederle and J. Tolar, Czech. J. Phys. **B23**, 871 (1973)
- [41] D. Hestenes and R. Ziegler, Projective Geometry with Clifford Algebra, Acta Applicandae Mathematicae **23** (1991) 25-63.
- [42] D. V Ahluwalia and C. Burgard, General Relativity and Gravitation **28** (10) (1996) 1163. D.V. Ahluwalia: General Relativity and Gravitation **29** (12) (1997) 1491. D.V. Ahluwalia, Phys. Letts **A 275** (2000) 31. G.Adunas, E. Rodriguez-Milla and D.V. Ahluwalia, Phys. Letts **B 485** (2000) 215.
- [43] F.D. Smith, Int. Jour. of Theoretical Physics **24** (1985) 155. Int. Jour. of Theoretical Physics **25** (1985) 355. From Sets to Quarks [arXiv: hep-ph/9708379]. <http://www.innerx.net/personal/tsmith/clfpq.html>.
- [44] F. I. Cooperstock, V. Faraoini, " Extended Planck Scale " [arXiv: hep-th/0302080].
- [45] H. I. Arcos and J. G. Pereira, " Kerr-Newman solutions as a Dirac particle" [arXiv: hep-th/0210103].
- [46] W. Smilga: Higher order terms in the contraction of  $S0(3,2)$  [arXiv: hep-th/0304137]. A. Wyler, C. R. Acad. Sc. Paris **269** (1969) 743-745.
- [47] C.Beck, *Spatio-Temporal Vacuum fluctuations of Quantized Fields* . World Scientific series in Advances in Nonlinear Dynamics, vol. 21 (2002).
- [48] G. Trayling and W. Baylis, J. Phys. **A 34** (2001) 3309. J. Chisholm and R. Farwell: J. Phys. **A 32** (1999) 2805. J. Chisholm and R. Farwell: Foundations of Physics **25** (1995) 1511.
- [49] M. Born: Proc. Royal Society **A 165** (1938) 291. Rev. Mod. Physics **21** (1949) 463.
- [50] *Clifford (Geometric) Algebras, with applications to Physics, Mathematics and Engineering* W. E. Baylis, editor; Birkhauser, Boston, 1997.
- [51] S. Somaro: Higher Spin and the Spacetime Algebra V. Dietrich et al. (eds), *Clifford Algebras and their Applications in Mathematical Physics* (1998) 347-368; Kluwer Academic Publishers, the Netherlands.
- [52] E. Caianiello, "Is there a maximal acceleration?", Lett. Nuovo Cimento **32** (1981) 65.
- [53] V. Nesterenko, Class. Quant. Grav. **9** (1992) 1101; Phys. Lett. **B 327** (1994) 50;

- [54] V. Bozza, A. Feoli, G. Lambiase, G. Papini and G. Scarpetta, Phys. Lett **A 283** (2001) 53. V. Nesterenko, A. Feoli, G. Lambiase and G. Scarpetta, Phys. Rev **D 60**, 065001 (1999).
- [55] K. Rama, "Classical velocity in kappa-deformed Poincare algebra and a maximal acceleration" [arXiv: hep-th/0209129].
- [56] H. Brandt: Contemporary Mathematics **196** (1996) 273. Chaos, Solitons and Fractals **10** (2-3) (1999) 267.
- [57] M.Pavšič: Phys. Lett **B 205** (1988) 231 ; Phys. Lett **B 221** (1989) 264. H. Arodz, A. Sitarz, P. Wegrzyn: Acta Physica Polonica **B 20** (1989) 921
- [58] M. Plyushchay, " Comment on the relativistic particle with curvature and torsion of world trajectory" [arXiv: hep-th/9810101]. Mod.Phys.Lett. A10 (1995) 1463-1469
- [59] E. Ramos, J. Roca, Nucl.Phys. B477 (1996) 606-622
- [60] H. Kleinert, A.M Chervyakov, " Evidence for Negative Stiffness of QCD Strings " [arXiv: hep-th/9601030].
- [61] F. Schuller, Annals of Phys. **299** (2002) 174.
- [62] A. Chernitskii: Born-Infeld electrodynamics, Clifford numbers and spinor representations [arXiv: hep-th/0009121].
- [63] J. Lukierski, A. Nowicki, H. Ruegg, V. Tolstoy, Phys. Lett **264** (1991) 331. J. Lukierski, H. Ruegg, W. Zakrzewski: Ann. Phys **243** (1995) 90. J. Lukierski, A. Nowicki: Double Special Relativity versus kappa-deformed dynamics. [arXiv: hep-th/0203065].
- [64] J. Webb, M. Murphy, V. Flambaum, V. Dzuba, J. Barrow, C. Churchill, J. Prochaska, and A. Wolfe, " Further evidence for Cosmological Evolution of the Fine Structure Constant " Monthly Notices of the Royal Astronomical Society **327** (2001) 1208.
- [65] J.P. Uzan, " The fundamental constants and their variations: observational status and theoretical motivations" [arXiv: hep-ph/0205340].
- [66] L. Anchordogui, H. Goldberg, Phys. Rev. **D 68** (2003) 083513.
- [67] G. Lambiase, G.Papini. G. Scarpetta: Maximal Acceleration Corrections to the Lamb Shift of one Electron Atoms [ arXiv: hep-th/9702130]. G. Lambiase, G.Papini. G. Scarpetta, Phys. Lett **A 224** (1998) 349. G. Papini, " Shadows of a maximal acceleration" [arXiv: gr-qc/0211011].
- [68] C. Castro, Int. J. Mod. Phys. A **18** (2003) 5445 [arXiv: hep-th/0210061]
- [69] L. Castellani: Phys. Lett **B 327** (1994) 22. Comm. Math. Phys **171** (1995) 383.

- [70] G.Amelino-Camelia, Phys. Lett **B 510** (2001) 255. Int. J. Mod. Phys **D 11** (2002) 35. Int. J. Mod. Phys **D 11** (2002) 1643.
- [71] K. Greisen, Phys. Rev. Lett **16** (1966) 748. G.T. Zatsepin, V. Kurmin, Sov. Phys. JETP Lett **4** (1966) 78.
- [72] J. Ellis, N. Mavromatos and D. V. Nanopolous, Chaos, Solitons and Fractals, **10** (1999) 345.
- [73] M. Toller, “The Geometry of Maximal Acceleration” [ArXiv: hep-th/0312016].
- [74] S. Low: Jour. Phys **A Math. Gen 35** (2002) 5711.
- [75] C.Castro, Mod. Phys. Letts. **A 19** (2004) 19
- [76] Y. Choquet-Bruhat, C. DeWitt-Morette and M. Dillard-Bleick, *Analysis, Manifolds and Physics* (revised edition), North Holland Publ. Co., Amsterdam, 1982.
- [77] A. Crumeyrole, *Orthogonal and Symplectic Clifford Algebras*, Kluwer Acad, Publ., Dordrecht, 1990.
- [78] H. Blaine Lawson and M.L. Michelson, *Spin Geometry*, Princeton University Press, Princeton, 1980.
- [79] A.M.Moya, V.V Fernandez and W.A. Rodrigues, Int.J.Theor.Phys. **40** (2001) 2347-2378 [arXiv: math-ph/0302007]; *Multivector Functions of a Multivector Variable* [arXiv: math.GM/0212223]; *Multivector Functionals* [arXiv: math.GM/0212224]
- [80] C. Castro, “The charge-mass-spin relationship of a Clifford polyparticle, Kerr-Newman Black holes and the Fine structure Constant”, to appear in Foundations of Physics.
- [81] S. Vacaru and N Vicol, ” Nonlinear Connections and Clifford Structures” [ arXiv : math.DG/0205190]. S. Vacaru, ” (Non) Commutative Finsler Geometry from String/M Theory ” [arXiv: hep-th/0211068]. S. Vacaru, A. Nadejda, Int. J. Math. Math. Sci. **23** (2004) 1189-1233. S. Vacaru, ”Clifford Structures and Spinors on Spaces with Local Anisotropy”, Buletinul Academiei de Stiinte a Republicii Moldova, Fizica si Tehnica [Izvestia Academii Nauk Respubliky Moldova, fizica i tehnika], **3**, 53-62 (1995), Matscinet: 98i:53022 S. Vacaru, ”Superstrings in Higher Order Extensions of Finsler Superspaces”, Nucl. Phys. B, **434** (1997) 590 -656. S. Vacaru and P. Stavrinou, ”Spinors and Space-Time Anisotropy” (Athens University Press, Athens, Greece, 2002), 301 pages, [ arXiv : gr-qc/0112028].
- [82] I.Kanatchikov, Rep. Math. Phys **43** (1999) 157. V. Kisil, [arXiv: quant-ph/0306101].
- [83] N. Bjerrus-Bohr, ” Quantum Gravity at large number of dimensions” [arXiv: hep-th/0310263]. J.F. Donoghue, Phys. Rev. **D 50** (1994) 3874. A. Strominger, Phys. Rev. **D 24** (1981) 3082.

- [84] W.A. Rodrigues, Jr, J. Vaz, Jr, Adv. Appl. Clifford Algebras **7** ( 1997 ) 457-466. E.C de Oliveira and W.A. Rodrigues, Jr, Ann. der Physik **7** ( 1998 ) 654-659. Phys. Lett bf A 291 ( 2001 ) 367-370. W.A. Rodrigues, Jr, J.Y.Lu, Foundations of Physics **27** ( 1997 ) 435-508.
- [85] P. Ramond, " Exceptional Groups and Physics " [arXiv: hep-th/0301050]
- [86] . B. Fauser, " A treatise on Quantum Clifford Algebras" [ arXiv: math.QA/0202059.]
- [87] M. Altaisky, " Wavelet based regularization for Euclidean field theory and stochastic quantization " [arXiv: hep-th/0311048].
- [88] V. Tapia, " Polynomial identities for Hypermatrices" [ arXiv: math-ph/0208010].
- [89] M. Defaria-Rosa, E. Recami and W. Rodrigues, Phys. Letts **B 173** (1986) 233.
- [90] E. Capelas de Oliveira and W.A Rodrigues, " Clifford valued Differential Forms, Algebraic spinor fields, Gravitation, Electromagnetism and " unified " theories " [arXiv: math-ph/0311001].
- [91] C. Lanczos, Z. Physik **57** (1929) 447–473; ibid 474-483; ibid 484–493; C. Lanczos, Physik. Zeitschr. **31** (1930) 120–130.
- [92] F. Gursev, *Applications of Quaternions to Field Equations*, Ph.D thesis, University of London (1950) 204 pp.
- [93] R.A. Mosna and W.A. Rodrigues, Jr., J. Math. Phys. **45** (2004) 7 [arXiv: math-ph/0212033]; W.A. Rodrigues, J. Math. Phys. **45** (2004) (to appear) [arXiv: math-ph/0212030]
- [94] K. Avinash and V. I. Rvachev, Foundations of Physics **30**(2000) 139.
- [95] D. Gottesman, "The Heisenberg Representation of Quantum Computers" [ArXiv: quant-ph9807006].
- [96] J. Baugh, D, Finkelstein, A. Galiatdinov and M. Shiri-Garakaui, Found.Phys. 33 (2003) 1267-1275
- [97] S.L. Adler, *Quaternionic Quantum Mechanics and Quantum Fields* Oxford Univ. Press, New York, 1995.
- [98] S. de Leo and K. Abdel-Khalek, " Towards an Octonionic World " [arXiv:hep-th/9905123]. S. de Leo, " Hypercomplex Group Theory " [arXiv: physics/9703033].
- [99] C.Castro, " Noncommutative QM and Geometry from quantization in C-spaces " [arXiv: hep-th/0206181].
- [100] M. Watkins, " Number theory and Physics " website, <http://www.maths.ex.ac.uk/mwatkins>



- [101] V. Vladimorov, I. Volovich and I. Zelenov, *p-adic Numbers in Mathematical Physics* World Scientific, 1994, Singapore. L. Brekke and P. Freund, Phys. Reports **231** (1991) 1. M. Pitkanen, *Topological Geometro-dynamics* <http://www.physics.helsinki.fi/matpitka/tgd.html>
- [102] C.N. Yang, Phys. Rev. **72** (1947) 874; H.S. Snyder, Phys. Rev. **71** (1947) 38. H.S. Snyder, Phys. Rev **72** (1947) 68. S. Tanaka, Yang's Quantized Spacetime Algebra and Holographic Hypothesis [arXiv: hep-th/0303105].
- [103] W. da Cruz: "Fractal von Neumann Entropy" [arXiv: cond-mat/0201489]. "Fractons and Fractal Statistics " arXiv: hep-th/9905229.
- [104] C.Castro, Chaos, Solitons and Fractals **14** (2002) 1341. **ibid** **15** (2003) 797. M. Lapidus and M. Frankenhuysen, *Fractal strings, complex dimensions and the zeros of the zeta function* Birkhauser, New York (2000).
- [105] C. Castro, " The Nonextensive Statistics of Fractal Strings and Branes " to appear in Physica **A** . J. Havrda and F. Charvat: Kybernetika **3** (1967) 30. C-Tsallis, Jour. of Statistical Physics **52** (1988) 479. C.Tsallis, " Non-extensive Statistical mechanics: A brief review of its present status " [arXiv: cond-mat/0205571].
- [106] D. Frieden, *Physics from Fisher Information Theory*, Cambridge University Press 1998.
- [107] T. Nowotny, M. Requardt, Chaos, Solitons and Fractals **10** (1999) 469.
- [108] , F. Lizzi, R.J Szabo, Chaos, Solitons and Fractals **10** (1999) 445.
- [109] I. Raptis, " Quantum Space-Time as a Quantum Causal Set" [arXiv gr-qc/0201004]. " Presheaves, Sheaves and their Topoi in Quantum Gravity and Quantum Logic" [arXiv: gr-qc/0110064]. " Non-Commutative Topology for Curved Quantum Causality " [arXiv: gr-qc/0101082].
- [110] C. Isham and J. Butterfield, Found.Phys. 30 (2000) 1707-1735. A. K. Guts, E. B. Grinkevich, " Toposes in General Theory of Relativity " [arXiv: gr-qc/9610073].
- [111] A. Ashtekar, C. Rovelli and L. Smolin, Phys. Rev. Lett **69** (1992) 237. C. Rovelli, " A dialog on quantum gravity " [arXiv: hep-th/0310077] L. Freidel, E. Livine and Carlo Rovelli, Class.Quant.Grav. 20 (2003) 1463-1478. L. Smolin, " How far are we from the quantum theory of gravity? " [ arXiv:hep-th/0303185]
- [112] M.Saniga, Chaos, Solitons and Fractals 19 (2004) 739-741
- [113] Norma Mankoc Borstnik and H.B. Nielsen, J. Math. Phys. 44 (2003) 4817-4827
- [114] L. Castellani, Class. Quant. Grav. 17 (2000) 3377-3402 Phys.Lett. B327 (1994) 22-28
- [115] E. Guendelman, E. Nissimov and S. Pacheva, " Strings, p-Branes and Dp-Branes With Dynamical Tension ". hep-th/0304269

- [116] P. Bouwknegt, K. Schouetens, Phys. Reports **223** (1993) 183-276. E. Sezgin, "Aspects of  $W_\infty$  Symmetry" hep-th/9112025. X. Shen, Int.J.Mod.Phys. A7 (1992) 6953-6994.
- [117] M. Vasiliev: "Higher Spin Gauge Theories, Star Product and AdS spaces" [arXiv: hep-th/9910096]. M. Vasiliev, S. Prokushkin: "Higher-Spin Gauge Theories with Matter". [arXiv: hep-th/9812242, hep-th/9806236].
- [118] Y. Ne'eman, E. Eizenberg, "Membranes and Other Extendons ( $p$ -branes)", World Scientific Lecture Notes in Physics vol. **39** 1995. J. Polchinski, *Superstrings*. Cambridge University Press (2000). M. Green, J. Schwarz and E. Witten, *Superstring Theory*. Cambridge University Press (1986).
- [119] J. Maldacena, Adv. Theor. Math. Phys **2** (1998) 231.
- [120] Y.Cho, K, Soh, Q. Park, J. Yoon: Phys. Letts **B 286** (1992) 251. J. Yoon, Phys. Letts **B 308** (1993) 240; J. Yoon, Phys. Lett **A 292** (2001) 166. J. Yoon, Class. Quan. Grav **16** (1999) 1863.
- [121] C. Castro, Europhysics Letters **61** (4) (2003) 480. Class. Quant. Gravity **20** no. 16 (2003) 3577.
- [122] A.B. Zamoldchikov, Teor. Fiz **65** (1985) 347 Pope et al C. Pope, Nucl.Phys. B413 (1994) 413-432 C. Pope, L. Romans, X. Shen, Nuc. Phys, **B 339** (1990) 191. C. Pope, L. Romans, X. Shen, Phys. Letts **B 236** (1990) 173. C. Pope, L. Romans, X. Shen, Phys. Letts **B 242** (1990) 401.
- [123] B. Dolan, TchraKian: Phys. Letts **B 202** (2) (1988) 211.
- [124] E. Hawkins, F. Markopoulou and H. Sahlmann "Evolution in Quantum Causal Histories" [arXiv ; hep-th/0302111]. F. Markopolu, L. Smolin, "Quantum Theory from Quantum Gravity" [arXiv: gr-qc/0311059].
- [125] M.Douglas, N. Nekrasov, Rev.Mod.Phys. 73 (2001) 977-1029
- [126] T. Eguchi, *Phys. Rev. Lett.* **44**, 126 (1980)
- [127] C. Castro, "Maximal-acceleration phase space relativity from Clifford algebras" [arXiv: hep-th/0208138].
- [128] V. Abramov, R. Kerner and B. Le Roy, J.Math.Phys. 38 (1997) 1650-1669
- [129] J. Cresson, "Scale calculus and the Schrodinger equation" [arXiv: math.GM/0211071].
- [130] E.H. Kinani, "Between Quantum Virasoro Algebras and Generalized Clifford Algebras [arXiv: math-ph/0310044].

- [131] S. Capozziello, S. Carloni and A. Troisi, " Quintessence without scalar fields " [arXiv: astro-ph/0303041]. S. Carroll, V. Duvvuri, M. Trodden and M. Turner, " Is Cosmic Speed-Up Due to New Gravitational Physics? " [arXiv: astro-ph/0306438]. A. Lue, R. Scoccimarro and G. Strakman, " Differentiating between Modified Gravity and Dark Energy " [arXiv: astro-ph/0307034].
- [132] A. Aurilia, A. Smailagic and E. Spallucci, *Physical Review D* **47**,2536 (1993); A. Aurilia and E. Spallucci, *Classical and Quantum Gravity* **10**, 1217 (1993); A. Aurilia, E. Spallucci and I. Vanzetta, *Physical Review D* **50**, 6490 (1994); S. Ansoldi, A. Aurilia and E. Spallucci, *Physical Review D* **53**, 870 (1996); S. Ansoldi, A. Aurilia and E. Spallucci, *Physical Review D* **56**, 2352 (1997)
- [133] R. A. Mosna, D. Miralles and J. Vaz Jr, "  $Z_2$ -gradings of Clifford algebras and multivector structures " [ arXiv : math-ph/0212020] .
- [134] C.Castro, "On Noncommutative Yang's space-time algebra, Holography, Area Quantization and C-space Relativity " submitted to Eur. Physics Journal C, CERN-EXT-2004-090 preprint. " Noncommutative Branes in Clifford Space Backgrounds and Moyal-Yang star products with UV-IR cutoffs " submitted to the Jour. Math. Phys ( 2005 ).
- [135] J. Armenta, J. A. Nieto, " The de Sitter Relativistic Top Theory" [ arXiv : 0405254 ] . J.A.Nieto, "Chirotope Concept in Various Scenarios of Physics" [arXiv : hep-th/0407093]. J.A.Nieto, "Matroids and p-branes", Adv.Theor.Math.Phys. 8 (2004) 177-188
- [136] C.N Yang, Phys. Rev **72** ( 1947 ) 874. Proceedings of the International Conference on Elementary Particles, ( 1965 ) Kyoto, pp. 322-323.
- [137] S.Tanaka, Nuovo Cimento **114 B** ( 1999 ) 49. S. Tanaka, " Noncommutative Field Theory on Yang's Space-Time Algebra, Covariant Moyal Star products and Matrix Model " [ arXiv : hep-th/0406166 ] . " Space-Time Quantization and Nonlocal Field Theory ..." [ arXiv : hep-th/0002001 ] . "Yang's Quantized Space-Time Algebra and Holographic Hypothesis " [ arXiv : hep-th/0303105] .
- [138] C. Castro, " On Dual Phase Space Relativity, the Machian Principle and Modified Newtonian Dynamics" Progress in Theoretical and Experimental Physics, E-print Journal, March 10 ( 2005 ) 1-15. "The Extended Relativity Theory in Born-Clifford Phase Spaces with a Lower and Upper Length Scales and Clifford Group Geometric Unification" *submitted* to Foundations of Physics ( 2004 ) ; CDS-CERN-EXT-2004-128.
- [139] C. Castro, " Polyvector Super-Poincare Algebras, M, F Theory Algebras and Generalized Supersymmetry in Clifford Spaces" submitted to the Int. Jour. Mod. Phys **A** ( 2005).

- [140] M. Pavsic, "Kaluza Klein Theory without Extra Dimensions : Curved Clifford Space" arXiv.org: hep-th/0412255. " Clifford Spaces as a Generalization of Space-time : Prospects for QFT of Point Particles and Strings" hep-th/0501222. "An alternative approach to the relation between bosons and fermions : employing Clifford space" hep-th/0502067.

# On Area Coordinates and Quantum Mechanics in Yang's Noncommutative Spacetime with a lower and upper scale

Carlos Castro

Center for Theoretical Studies of Physical Systems  
Clark Atlanta University, Atlanta, GA. 30314, castro@ctsps.cau.edu

November 2005, Revised February 2006

## Abstract

We explore Yang's Noncommutative space-time algebra (involving *two* length scales) within the context of QM defined in Noncommutative spacetimes and the holographic area-coordinates algebra in Clifford spaces. Casimir invariant wave equations corresponding to Noncommutative coordinates and momenta in  $d$ -dimensions can be recast in terms of *ordinary* QM wave equations in  $d + 2$ -dimensions. It is conjectured that QM over Noncommutative spacetimes (Noncommutative QM) may be described by ordinary QM in *higher* dimensions. Novel Moyal-Yang-Fedosov-Kontsevich star products deformations of the Noncommutative Poisson Brackets are employed to construct star product deformations of scalar field theories. Finally, generalizations of the Dirac-Konstant and Klein-Gordon-like equations relevant to the physics of  $D$ -branes and Matrix Models are presented.

## 1 Introduction

Yang's noncommutative space time algebra [?] is a generalization of the Snyder algebra [?] (where now both coordinates and momenta are not commuting) that has received more attention recently, see for example [?] and references therein. In particular, Noncommutative p-brane actions, for even  $p+1 = 2n$ -dimensional world-volumes, were written explicitly [?] in terms of the *novel* Moyal-Yang ( Fedosov-Kontsevich ) star product deformations [?], [?] of the Noncommutative Nambu Poisson Brackets (NCNPB) that are associated with the *noncommuting* world-volume coordinates  $q^A, p^A$  for  $A = 1, 2, 3, \dots, n$ . The latter noncommuting coordinates obey the noncommutative Yang algebra with an ultraviolet  $L_P$

(Planck) scale and infrared ( $R$ ) scale cutoff. It was shown why the novel p-brane actions in the "classical" limit  $\hbar_{eff} = \hbar L_P / R \rightarrow 0$  still acquire nontrivial noncommutative *corrections* that differ from ordinary p-brane actions. Super p-branes actions in the light-cone gauge are also amenable to Moyal-Yang star product deformations as well due to the fact that p-branes moving in flat spacetime backgrounds, in the light-cone gauge, can be recast as gauge theories of volume-preserving diffeomorphisms. The most general construction of noncommutative super p-branes actions based on non (anti) commuting superspaces and quantum group methods remains an open problem.

The purpose of this work is to explore further the consequences of Yang's Noncommutative spacetime algebra within the context of QM in Noncommutative spacetimes and the holographic area-coordinates algebra in Clifford spaces [?]. In section 2 we study the interplay among Yang's Noncommutative spacetime algebra and the former area-coordinates algebra in Clifford spaces. In section 3 we show how Casimir invariant wave equations corresponding to Noncommutative coordinates and momenta in  $D$ -dimensions, can be recast in terms of ordinary QM wave equations in  $D + 2$ -dimensions. In particular, we shall present explicit solutions of the D'Alambertian operator in the *bulk* of  $AdS$  spaces and explain its correspondence with the Casimir invariant wave equations associated with the Yang's Noncommutative spacetime algebra at the projective *boundary* of the conformally compactified  $AdS$  spacetime. We conjecture that QM over Noncommutative spacetimes ( Noncommutative QM ) may be described by ordinary QM in *higher* dimensions.

In section 4 we recur to the *novel* Moyal-Yang (Fedosov-Kontsevich) star products [?], [?] deformations of the Noncommutative Poisson Brackets to construct Moyal-Yang star product deformations of scalar field theories. The role of star products in the construction of  $p$ -branes actions from the large  $N$  limit of  $SU(N)$  Yang-Mills can be found in [?] and in the Self-Dual Gravity/  $SU(\infty)$  Self Dual Yang-Mills relation in [?], [?], [?].[?]. Finally, in the conclusion 5, we present the generalizations of the Dirac-Konstant equations (and their "square" Klein-Gordon type equations) that are relevant to the incorporation of fermions and the physics of  $D$ -branes and Matrix Models.

## 2 Noncommutative Yang's Spacetime Algebra in terms of Area-Coordinates in Clifford Spaces

The main result of this section is that there is a *subalgebra* of the C-space operator-valued coordinates [?] which is *isomorphic* to the Noncommutative Yang's spacetime algebra [?], [?]. This, in conjunction to the discrete spectrum of angular momentum, leads to the discrete area quantization in multiples of Planck areas. Namely, the  $4D$  Yang's Noncommutative space-time algebra [?] (written in terms of  $8D$  phase-space coordinates) is isomorphic to the 15-dimensional *subalgebra* of the C-space operator-valued coordinates associated

with the *holographic areas* of C-space. This connection between Yang's algebra and the 6D Clifford algebra is possible because the 8D phase-space coordinates  $x^\mu, p^\mu$  ( associated to a 4D spacetime ) have a one-to-one correspondence to the  $\hat{X}^{\mu 5}, \hat{X}^{\mu 6}$  holographic area-coordinates of the C-space (corresponding to the 6D Clifford algebra). Furthermore, Tanaka [?] has shown that the Yang's algebra [?] ( with 15 generators ) is related to the 4D conformal algebra (15 generators) which in turn is isomorphic to a subalgebra of the 4D Clifford algebra because it is known that the 15 generators of the 4D conformal algebra  $SO(4, 2)$  can be explicitly realized in terms of the 4D Clifford algebra as shown in [?].

The correspondence between the holographic area coordinates  $X^{AB} \leftrightarrow \lambda^2 \Sigma^{AB}$  and the angular momentum variables when  $A, B = 1, 2, 3, \dots, 6$  yields an isomorphism between the holographic area coordinates algebra in Clifford spaces [?] and the noncommutative Yang's spacetime algebra in  $D = 4$ . The scale  $\lambda$  is the ultraviolet lower Planck scale. We begin by writing the exchange algebra between the position and momentum coordinates encapsulated by the commutator :

$$[\hat{X}^{\mu 6}, \hat{X}^{56}] = -i\lambda^2 \eta^{66} \hat{X}^{\mu 5} \leftrightarrow \left[ \frac{\lambda^2 R}{\hbar} \hat{p}^\mu, \lambda^2 \Sigma^{56} \right] = -i\lambda^2 \eta^{66} \lambda \hat{x}^\mu. \quad (2.1)$$

from which we can deduce that :

$$[\hat{p}^\mu, \Sigma^{56}] = -i\eta^{66} \frac{\hbar}{\lambda R} \hat{x}^\mu. \quad (2.2)$$

hence, after using the definition  $\mathcal{N} = (\lambda/R)\Sigma^{56}$ , where  $R$  is the infrared upper scale, one has the exchange algebra commutator of  $p^\mu$  and  $\mathcal{N}$  of the Yang's spacetime algebra given by

$$[\hat{p}^\mu, \mathcal{N}] = -i\eta^{66} \frac{\hbar}{R^2} \hat{x}^\mu. \quad (2.3)$$

From the commutator

$$[\hat{X}^{\mu 5}, \hat{X}^{56}] = -[\hat{X}^{\mu 5}, \hat{X}^{65}] = i\eta^{55} \lambda^2 \hat{X}^{\mu 6} \leftrightarrow [\lambda \hat{x}^\mu, \lambda^2 \Sigma^{56}] = i\eta^{55} \lambda^2 \lambda^2 \frac{R}{\hbar} \hat{p}^\mu. \quad (2.4)$$

we can deduce that

$$[\hat{x}^\mu, \Sigma^{56}] = i\eta^{55} \frac{\lambda R}{\hbar} \hat{p}^\mu. \quad (2.5)$$

and after using the definition  $\mathcal{N} = (\lambda/R)\Sigma^{56}$  one has the exchange algebra commutator of  $x^\mu$  and  $\mathcal{N}$  of the Yang's spacetime algebra

$$[\hat{x}^\mu, \mathcal{N}] = i\eta^{55} \frac{\lambda^2}{\hbar} \hat{p}^\mu. \quad (2.6)$$

The other relevant holographic area-coordinates commutators in C-space are

$$[\hat{X}^{\mu 5}, \hat{X}^{\nu 5}] = -i\eta^{55}\lambda^2\hat{X}^{\mu\nu} \leftrightarrow [\hat{x}^\mu, \hat{x}^\nu] = -i\eta^{55}\lambda^2\Sigma^{\mu\nu}. \quad (2.7)$$

that yield the noncommuting coordinates algebra after having used the representation of the C-space operator holographic area-coordinates

$$i\hat{X}^{\mu\nu} \leftrightarrow i\lambda^2\frac{1}{\hbar}\mathcal{M}^{\mu\nu} = i\lambda^2\Sigma^{\mu\nu} \quad i\hat{X}^{56} \leftrightarrow i\lambda^2\Sigma^{56}. \quad (2.8)$$

where we appropriately introduced the Planck scale  $\lambda$  as one should to match units. From the correspondence

$$\hat{p}^\mu = \frac{\hbar}{R}\Sigma^{\mu 6} \leftrightarrow \frac{\hbar}{R}\frac{1}{\lambda^2}\hat{X}^{\mu 6}. \quad (2.9)$$

one can obtain nonvanishing momentum commutator

$$[\hat{X}^{\mu 6}, \hat{X}^{\nu 6}] = -i\eta^{66}\lambda^2\hat{X}^{\mu\nu} \leftrightarrow [\hat{p}^\mu, \hat{p}^\nu] = -i\eta^{66}\frac{\hbar^2}{R^2}\Sigma^{\mu\nu}. \quad (2.10)$$

The signatures for  $AdS_5$  space are  $\eta^{55} = +1$ ;  $\eta^{66} = -1$  and for the *Euclideanized*  $AdS_5$  space are  $\eta^{55} = +1$  and  $\eta^{66} = +1$ . Yang's space-time algebra corresponds to the latter case. Finally, the *modified* Heisenberg algebra can be read from the following C-space commutators :

$$\begin{aligned} [\hat{X}^{\mu 5}, \hat{X}^{\nu 6}] &= i\eta^{\mu\nu}\lambda^2\hat{X}^{56} \leftrightarrow \\ [\hat{x}^\mu, \hat{p}^\mu] &= i\hbar\eta^{\mu\nu}\frac{\lambda}{R}\Sigma^{56} = i\hbar\eta^{\mu\nu}\mathcal{N}. \end{aligned} \quad (2.11)$$

Eqs-(2.1-2.11) are the defining relations of Yang's Noncommutative  $4D$  space-time algebra [?] involving the  $8D$  phase-space variables. These commutators obey the Jacobi identities. There are other commutation relations like  $[\mathcal{M}^{\mu\nu}, x^\rho]$ , ... that we did not write down. These are just the well known rotations ( boosts ) of the coordinates and momenta.

When  $\lambda \rightarrow 0$  and  $R \rightarrow \infty$  one recovers the ordinary *commutative* spacetime algebra. The Snyder algebra [?] is recovered by setting  $R \rightarrow \infty$  while leaving  $\lambda$  intact. To recover the ordinary Weyl-Heisenberg algebra is more subtle. Tanaka [?] has shown the the *spectrum* of the operator  $\mathcal{N} = (\lambda/R)\Sigma^{56}$  is discrete given by  $n(\lambda/R)$ . This is not suprising since the angular momentum generator  $\mathcal{M}^{56}$  associated with the *Euclideanized*  $AdS_5$  space is a rotation in the now compact  $x^5 - x^6$  directions. This is not the case in  $AdS_5$  space since  $\eta^{66} = -1$  and this timelike direction is no longer compact. Rotations involving timelike directions are equivalent to noncompact boosts with a continuous spectrum.

In order to recover the standard Weyl-Heisenberg algebra from Yang's Noncommutative spacetime algebra, and the standard uncertainty relations  $\Delta x \Delta p \geq \hbar$  with the ordinary  $\hbar$  term, rather than the  $n\hbar$  term, one needs to take the limit  $n \rightarrow \infty$  limit in such a way that the net combination of  $n\frac{\lambda}{R} \rightarrow 1$ . This can be attained when one takes the *double* scaling limit of the quantities as follows

$$\lambda \rightarrow 0. \quad R \rightarrow \infty. \quad \lambda R \rightarrow L^2.$$



$$\lim_{n \rightarrow \infty} n \frac{\lambda}{R} = n \frac{\lambda^2}{\lambda R} = \frac{n\lambda^2}{L^2} \rightarrow 1. \quad (2.12)$$

From eq-(2.12) one learns then that :

$$n\lambda^2 = \lambda R = L^2. \quad (2.13)$$

The spectrum  $n$  corresponds to the quantization of the angular momentum operator in the  $x^5 - x^6$  direction (after embedding the  $5D$  hyperboloid of throat size  $R$  onto  $6D$ ). Tanaka [?] has shown why there is a *discrete spectra* for the *spatial* coordinates and *spatial* momenta in Yang's spacetime algebra that yields a *minimum* length  $\lambda$  (ultraviolet cutoff in energy) and a minimum momentum  $p = \hbar/R$  (maximal length  $R$ , infrared cutoff). The energy and temporal coordinates had a continuous spectrum.

The physical interpretation of the double-scaling limit of eq-(2.12) is that the area  $L^2 = \lambda R$  becomes now *quantized* in units of the Planck area  $\lambda^2$  as  $L^2 = n\lambda^2$ . Thus the quantization of the area (via the double scaling limit)  $L^2 = \lambda R = n\lambda^2$  is a result of the *discrete* angular momentum spectrum in the  $x^5 - x^6$  directions of the Yang's Noncommutative spacetime algebra when it is realized by (angular momentum) differential operators acting on the *Euclideanized*  $AdS_5$  space (two branches of a  $5D$  hyperboloid embedded in  $6D$ ). A general interplay between quantum of areas and quantum of angular momentum, for arbitrary values of spin, in terms of the square root of the Casimir  $\mathbf{A} \sim \lambda^2 \sqrt{j(j+1)}$ , has been obtained a while ago in Loop Quantum Gravity by using spin-networks techniques and highly technical area-operator regularization procedures [?].

The advantage of this work is that we have arrived at similar (not identical) area-quantization conclusions in terms of minimal Planck areas and a discrete angular momentum spectrum  $n$  via the double scaling limit based on Clifford algebraic methods (C-space holographic area-coordinates). This is not surprising since the norm-squared of the holographic Area operator has a correspondence with the quadratic Casimir  $\Sigma_{AB}\Sigma^{AB}$  of the conformal algebra  $SO(4,2)$  ( $SO(5,1)$  in the Euclideanized  $AdS_5$  case). This quadratic Casimir must not be confused with the  $SU(2)$  Casimir  $J^2$  with eigenvalues  $j(j+1)$ . Hence, the correspondence given by eqs-(2.3-2.8) gives  $\mathbf{A}^2 \leftrightarrow \lambda^4 \Sigma_{AB}\Sigma^{AB}$ .

In [?] we have shown why  $AdS_4$  gravity with a topological term; i.e. an Einstein-Hilbert action with a cosmological constant plus Gauss-Bonnet terms can be obtained from the vacuum state of a **BF**-Chern-Simons-Higgs theory *without* introducing by *hand* the zero torsion condition imposed in the McDowell-Mansouri-Chamsedine-West construction. One of the most salient features of [?] was that a *geometric mean* relationship was found among the cosmological constant  $\Lambda_c$ , the Planck area  $\lambda^2$  and the  $AdS_4$  throat size squared  $R^2$  given by  $(\Lambda_c)^{-1} = (\lambda)^2 (R^2)$ . Upon setting the throat size to be of the order of the Hubble scale  $R_H$  and  $\lambda = L_P$  (Planck scale), one recovers the observed value of the cosmological constant  $L_P^{-2} R_H^{-2} = L_P^{-4} (L_P/R_H)^2 \sim 10^{-120} M_P^4$ . A similar geometric mean relation is also obeyed by the condition  $\lambda R = L^2 (= n\lambda^2)$  in the double scaling limit of Yang's algebra which suggests to identify the cosmological con-

stant as  $\Lambda_c = L^{-4}$ . This geometric mean condition remains to be investigated further. In particular, we presented the preliminary steps how to construct a Noncommutative Gravity via the Vasiliev-Moyal star products deformations of the  $SO(4, 2)$  algebra used in the study of higher conformal massless spin theories in  $AdS$  spaces by taking the inverse-throat size  $1/R$  as a deformation parameter of the  $SO(4, 2)$  algebra. A Moyal deformation of ordinary Gravity via  $SU(\infty)$  gauge theories was advanced in [?].

### 3 Noncommutative QM in Yang's Spacetime from ordinary QM in Higher Dimensions

In order to write wave equations in non-commuting spacetimes we start with a Hamiltonian written in *dimensionless* variables involving the terms of the relativistic oscillator ( let us say oscillations of the center of mass ) and the rigid rotor/top terms ( rotations about the center of mass ) :

$$H = \left(\frac{p_\mu}{(\hbar/R)}\right)^2 + \left(\frac{x_\mu}{L_P}\right)^2 + (\Sigma^{\mu\nu})^2. \quad (3.1)$$

with the fundamental difference that the coordinates  $x^\mu$  and momenta  $p^\mu$  obey the non-commutative Yang's space time algebra. For this reason one *cannot* naively replace  $p^\mu$  any longer by the differential operator  $-i\hbar\partial/\partial x^\mu$  nor write the  $\Sigma^{\mu\nu}$  generators as  $(1/\hbar)(x^\mu\partial_{x^\nu} - x^\nu\partial_{x^\mu})$ . The correct coordinate realization of Yang's noncommutative spacetime algebra requires, for example, embedding the 4-dim space into 6-dim and expressing the coordinates and momenta operators as follows :

$$\begin{aligned} \frac{p_\mu}{(\hbar/R)} \leftrightarrow \Sigma^{\mu 6} &= i\frac{1}{\hbar}(X^\mu\partial_{X_6} - X^6\partial_{X_\mu}), & \frac{x_\mu}{L_P} \leftrightarrow \Sigma^{\mu 5} &= i\frac{1}{\hbar}(X^\mu\partial_{X_5} - X^5\partial_{X_\mu}), \\ \Sigma^{\mu\nu} \leftrightarrow i\frac{1}{\hbar}(X^\mu\partial_{X_\nu} - X^\nu\partial_{X_\mu}), & \mathcal{N} = \Sigma^{56} \leftrightarrow i\frac{1}{\hbar}(X^5\partial_{X_6} - X^6\partial_{X_5}). \end{aligned} \quad (3.2)$$

this allows to express  $H$  in terms of the standard angular momentum operators in 6-dim. The  $X^A = X^\mu, X^5, X^6$  coordinates ( $\mu = 1, 2, 3, 4$ ) and  $P^A = P^\mu, P^5, P^6$  momentum variables obey the standard commutation relations of ordinary QM in 6-dim

$$[X^A, X^B] = 0. \quad [P^A, P^B] = 0. \quad [X^A, P^B] = i\hbar\eta^{AB}. \quad (3.3)$$

so that the momentum admits the standard realization as  $P^A = -i\hbar\partial/\partial X_A$

Therefore, concluding, the Hamiltonian  $H$  in eq-( 3-1) associated with the non-commuting coordinates  $x^\mu$  and momenta  $p^\mu$  in  $d - 1$ -dimensions can be written in terms of the standard angular momentum operators in  $(d - 1) + 2 =$

$d+1$ -dim as  $H = \mathcal{C}_2 - \mathcal{N}^2$ , where  $\mathcal{C}_2$  agrees precisely with the quadratic Casimir operator of the  $SO(d-1, 2)$  algebra in the spin  $s = 0$  case,

$$\mathcal{C}_2 = \Sigma_{AB}\Sigma^{AB} = (X_A\partial_B - X_B\partial_A)(X^A\partial^B - X^B\partial^A). \quad (3.4)$$

One remarkable feature is that  $\mathcal{C}_2$  also agrees with the D'Alembertian operator for the Anti de Sitter Space  $AdS_d$  of *unit radius* ( throat size )  $(D_\mu D^\mu)_{AdS_d}$  as it was shown by [?].

The proof requires to show that the D'Alembertian operator for the  $d+1$ -dim embedding space ( expressed in terms of the  $X^A$  coordinates ) is related to the D'Alembertian operator in  $AdS_d$  space of *unit radius* expressed in terms of the  $z^1, z^2, \dots, z^d$  *bulk intrinsic* coordinates as :

$$\begin{aligned} (D_\mu D^\mu)_{R^{d+1}} &= -\frac{\partial^2}{\partial \rho^2} - \frac{d}{\rho} \frac{\partial}{\partial \rho} + \frac{1}{\rho^2} (D_\mu D^\mu)_{AdS} \Rightarrow \\ \mathcal{C}_2 &= \rho^2 (D_\mu D^\mu)_{R^{d+1}} + \left[ (d-1) + \rho \frac{\partial}{\partial \rho} \right] \rho \frac{\partial}{\partial \rho} = (D_\mu D^\mu)_{AdS_d}. \end{aligned} \quad (3.5)$$

This result is just the hyperbolic-space generalization of the standard decomposition of the Laplace operator in spherical coordinates in terms of the radial derivatives plus a term containing the square of the orbital angular momentum operator  $L^2/r^2$ . In the case of nontrivial spin, the Casimir  $\mathcal{C}_2 = \Sigma_{AB}\Sigma^{AB} + S_{AB}S^{AB}$  has additional terms stemming from the spin operator.

The quantity  $\Phi(z^1, z^2, \dots, z^d)|_{boundary}$  restricted to the  $d-1$ -dim projective boundary of the conformally compactified  $AdS_d$  space ( of unit throat size, whose topology is  $S^{d-2} \times S^1$  ) is the sought-after solution to the Casimir invariant wave equation associated with the non-commutative  $x^\mu$  coordinates and momenta  $p^\mu$  of the Yang's algebra (  $\mu = 1, 2, \dots, d-1$  ). Pertaining to the boundary of the conformally compactified  $AdS_d$  space, there are two radii  $R_1, R_2$  associated with  $S^{d-2}$  and  $S^1$ , respectively, and which must not be confused with the two scales  $R, L_P$  appearing in eq-(3-1). One can choose the units such that the present value of the Hubble scale ( taking the Hubble scale as the infrared cutoff ) is  $R = 1$ . In these units the Planck scale  $L_P$  will be of the order of  $L_P \sim 10^{-60}$ . In essence, there has been a trade-off of two scales  $L_P, R$  with the two radii  $R_1, R_2$ .

Once can parametrize the coordinates of  $AdS_d = AdS_{p+2}$  by writing [?]

$$X_0 = R \cosh(\rho)\cos(\tau). \quad X_{p+1} = R \cosh(\rho)\sin(\tau). \quad X_i = R \sinh(\rho)\Omega_i. \quad (3.6a)$$

The metric of  $AdS_d = AdS_{p+2}$  space in these coordinates is :

$$ds^2 = R^2[-(\cosh^2 \rho)d\tau^2 + d\rho^2 + (\sinh^2 \rho)d\Omega^2]. \quad (3.6b)$$

where  $0 \leq \rho$  and  $0 \leq \tau < 2\pi$  are the global coordinates. The topology of this hyperboloid is  $S^1 \times R^{p+1}$ . To study the causal structure of  $AdS$  it is convenient to unwrap the circle  $S^1$  ( closed-timelike coordinate  $\tau$  ) to obtain the universal covering of the hyperboloid without closed-timelike curves and

take  $-\infty \leq \tau \leq +\infty$ . Upon introducing the new coordinate  $0 \leq \theta < \pi/2$  related to  $\rho$  by  $\tan(\theta) = \sinh(\rho)$ , the metric in (3-6b) becomes

$$ds^2 = \frac{R^2}{\cos^2\theta} [-d\tau^2 + d\theta^2 + (\sinh^2\rho)d\Omega^2]. \quad (3.7)$$

It is a conformally-rescaled version of the metric of the Einstein static universe. Namely,  $AdS_d = AdS_{p+2}$  can be conformally mapped into one-half of the Einstein static universe, since the coordinate  $\theta$  takes values  $0 \leq \theta < \pi/2$  rather than  $0 \leq \theta < \pi$ . The boundary of the conformally compactified  $AdS_{p+2}$  space has the topology of  $S^p \times S^1$  ( identical to the conformal compactification of the  $p + 1$ -dim Minkowski space ). Therefore, the equator at  $\theta = \pi/2$  is a *boundary* of the space with the topology of  $S^p$ .  $\Omega_p$  is the solid angle coordinates corresponding to  $S^p$  and  $\tau$  is the coordinate which parametrizes  $S^1$ . For a detailed discussion of  $AdS$  spaces and the  $AdS/CFT$  duality see [?] .

The D'Alambertian in  $AdS_d$  space ( of radius  $R$ , later we shall set  $R = 1$  ) is :

$$D_\mu D^\mu = \frac{1}{\sqrt{g}} \partial_\mu ( \sqrt{g} g^{\mu\nu} \partial_\nu ) = \frac{\cos^2\theta}{R^2} [ -\partial_\tau^2 + \frac{1}{(R \tan\theta)^p} \partial_\theta ( (R \tan\theta)^p \partial_\theta ) ] + \frac{1}{R^2 \tan^2\theta} \mathcal{L}^2 \quad (3.8)$$

where  $\mathcal{L}^2$  is the Laplacian operator in the  $p$ -dim sphere  $S^p$  whose eigenvalues are  $l(l + p - 1)$ .

The scalar field can be decomposed as  $\Phi = e^{\omega R\tau} Y_l(\Omega_p) G(\theta)$  and the wave equation

$$(D_\mu D^\mu - m^2)\Phi = 0. \quad (3.9)$$

leads to :

$$[ \cos^2\theta ( \omega^2 + \partial_\theta^2 + \frac{p}{\tan\theta \cos^2\theta} \partial_\theta ) + \frac{l(l+p-1)}{\tan^2\theta} - m^2 R^2 ] G(\theta) = 0. \quad (3.10)$$

whose solution is

$$G(\theta) = (\sin\theta)^l (\cos\theta)^{\lambda\pm} {}_2F_1(a, b, c; \sin\theta). \quad (3.11)$$

The hypergeometric function is defined

$${}_2F_1(a, b, c, z) = \sum \frac{(a)_k (b)_k}{(c)_k k!} z^k. \quad |z| < 1. \quad (3.12)$$

$$(\lambda)_0 = 1. \quad (\lambda)_k = \frac{\Gamma(\lambda + k)}{\Gamma(\lambda)} = \lambda(\lambda + 1)(\lambda + 2)\dots(\lambda + k - 1). \quad k = 1, 2, \dots \quad (3.13)$$

where

$$a = \frac{1}{2}(l + \lambda_{\pm} - \omega R). \quad b = \frac{1}{2}(l + \lambda_{\pm} + \omega R). \quad c = l + \frac{1}{2}(p + 1) > 0. \quad (3.14a)$$

$$\lambda_{\pm} = \frac{1}{2}(p + 1) \pm \frac{1}{2}\sqrt{(p + 1)^2 + 4(mR)^2}. \quad (3.14b)$$

The analytical continuation of the hypergeometric function for  $|z| \geq 1$  is :

$${}_2F_1(a, b, c, z) = \frac{\Gamma(c)}{\Gamma(b)\Gamma(c-b)} \int_0^1 t^{b-1}(1-t)^{c-b-1}(1-tz)^{-a} dt. \quad (3.15)$$

with  $Real(c) > 0$  and  $Real(b) > 0$ . The boundary value when  $\theta = \pi/2$  gives

$$\lim_{z \rightarrow 1^-} F(a, b, c; z) = \frac{\Gamma(c)\Gamma(c-a-b)}{\Gamma(c-a)\Gamma(c-b)}. \quad (3.16)$$

Let us study the behaviour of the solution  $G(\theta)$  in the massless case

$$m = 0. \quad \lambda_- = 0. \quad \lambda_+ = p + 1. \quad (3.17)$$

Solutions with  $\lambda_+ = p + 1$  yield a trivial value of  $G(\theta) = 0$  at the boundary  $\theta = \pi/2$  since  $\cos(\pi/2)^{p+1} = 0$ . Solutions with  $\lambda_- = 0$  lead to  $\cos(\theta)^{\lambda_-} = \cos(\theta)^0 = 1$  prior to taking the limit  $\theta = \pi/2$ . The expression  $\cos(\pi/2)^{\lambda_-} = 0^0 = 1$  is ill defined. Upon using L' Hopital rule it yields 0. Thus, the limit  $\theta = \pi/2$  must be taken afterwards the limit  $\lambda_- = 0$  :

$$\lim_{\theta \rightarrow \pi/2} [\cos(\theta)^{\lambda_-}] = \lim_{\theta \rightarrow \pi/2} [\cos(\theta)^0] = \lim_{\theta \rightarrow \pi/2} [1] = 1. \quad (3.18)$$

In this fashion the value of  $G(\theta)$  is well defined and nonzero at the boundary when  $\lambda_- = 0$  and leads to the value of the wavefunction at the boundary of the conformally compactified  $AdS_d$  ( for  $d = p + 2$  with radius  $R$  )

$$\Phi_{boundary} = e^{i\omega R\tau} Y_l(\Omega_p) \frac{\Gamma(l + (p + 1)/2)\Gamma((p + 1)/2)}{\Gamma(\omega R + (l + p + 1)/2)\Gamma(-\omega R + (l + p + 1)/2)} \quad (3.19a)$$

upon setting the radius of  $AdS_d$  space to *unity* it gives

$$\Phi_{boundary} = e^{i\omega\tau} Y_l(\Omega_p) \frac{\Gamma(l + (p + 1)/2)\Gamma((p + 1)/2)}{\Gamma(\omega + (l + p + 1)/2)\Gamma(-\omega + (l + p + 1)/2)}. \quad (3.19b)$$

Hence,  $\Phi_{boundary}$  in eq-(3-19b) is the solution to the Casimir invariant wave equation in the *massless*  $m = 0$  case :

$$\mathcal{C}_2 \Phi = [ (\frac{p_{\mu}}{\hbar/R})^2 + (\frac{x_{\mu}}{L_P})^2 + (\Sigma^{\mu\nu})^2 + \mathcal{N}^2 ] \Phi = 0. \quad (3.20)$$

And :

$$\left[ \left( \frac{p_\mu}{\hbar/R} \right)^2 + \left( \frac{x_\mu}{L_P} \right)^2 + (\Sigma^{\mu\nu})^2 \right] \Phi = [C_2 - \mathcal{N}^2] \Phi = -\omega^2 \Phi. \quad (\text{when } R = 1) \quad (3.21)$$

since  $\mathcal{N} = \Sigma^{56}$  is the rotation generator along the  $S^1$  component of  $AdS$  space. It acts as  $\partial/\partial\tau$  only on the  $e^{i\omega R\tau}$  piece of  $\Phi$ . Concluding:  $\Phi(z^1, z^2, \dots, z^d)|_{\text{boundary}}$ , restricted to the  $d-1$ -dim projective boundary of the conformally compactified  $AdS_d$  space ( of *unit* radius and topology  $S^{d-2} \times S^1$  ) given by eq-(3-19), is the sought-after solution to the wave equations (3-20, 3-21) associated with the non-commutative  $x^\mu$  coordinates and momenta  $p^\mu$  of the Yang's algebra and where the indices  $\mu$  range over the dimensions of the *boundary*  $\mu = 1, 2, \dots, d-1$ . This suggests that QM over Yang's Noncommutative Spacetimes could be well defined in terms of ordinary QM in *higher* dimensions ! This idea deserves further investigations. For example, it was argued by [?] that the *quantized* Nonabelian gauge theory in  $d$  dimensions can be obtained as the infrared limit of the corresponding *classical* gauge theory in  $d+1$ -dim.

## 4 Star Products and Noncommutative QM

The ordinary Moyal star-product of two functions in phase space  $f(x, p), g(x, p)$  is :

$$(f * g)(x, p) = \sum_s \frac{\hbar^s}{s!} \sum_{t=0}^s (-1)^t C(s, t) (\partial_x^{s-t} \partial_p^t f(x, p)) (\partial_x^t \partial_p^{s-t} g(x, p)) \quad (4.1)$$

where  $C(s, t)$  is the binomial coefficient  $s!/t!(s-t)!$ . In the  $\hbar \rightarrow 0$  limit the star product  $f * g$  reduces to the ordinary pointwise product  $fg$  of functions. The Moyal product of two functions of the  $2n$ -dim phase space coordinates  $(q_i, p_i)$  with  $i = 1, 2, \dots, n$  is:

$$(f * g)(x, p) = \sum_i \sum_s \frac{\hbar^s}{s!} \sum_{t=0}^s (-1)^t C(s, t) (\partial_{x_i}^{s-t} \partial_{p_i}^t f(x, p)) (\partial_{x_i}^t \partial_{p_i}^{s-t} g(x, p)) \quad (4.2)$$

The noncommutative, associative Moyal bracket is defined:

$$\{f, g\}_{MB} = \frac{1}{i\hbar} (f * g - g * f). \quad (4.3)$$

The task now is to construct *novel* Moyal-Yang star products based on the noncommutative spacetime Yang's algebra. A novel star product deformations of (super) p-brane actions based on the noncommutative spacetime Yang's algebra where the deformation parameter is  $\hbar_{eff} = \hbar L_P / R$ , for nonzero values of  $\hbar$ , was obtained in [?] The modified (noncommutative) Poisson bracket is now given by

$$\begin{aligned} & \{ \mathcal{F} (q^m, p^m), \mathcal{G} (q^m, p^m) \}_\Omega = (\partial_{q^m} \mathcal{F}) \{q^m, q^n\} (\partial_{q^n} \mathcal{G}) + \\ & (\partial_{p^m} \mathcal{F}) \{p^m, p^n\} (\partial_{p^n} \mathcal{G}) + (\partial_{q^m} \mathcal{F}) \{q^m, p^n\} (\partial_{p^n} \mathcal{G}) + (\partial_{p^m} \mathcal{F}) \{p^m, q^n\} (\partial_{q^n} \mathcal{G}). \end{aligned} \quad (4.4)$$

where the entries  $\{q^m, q^n\} \neq 0$ ,  $\{p^m, p^n\} \neq 0$ , and  $\{p^m, q^n\} = -\{q^n, p^m\}$  can be read from the commutators described in section 2 by simply defining the deformation parameter  $\hbar_{eff} \equiv \hbar(L_P/R)$ . One can generalize Yang's original 4-dim algebra to noncommutative  $2n$ -dim world-volumes and/or spacetimes by working with the  $2n + 2$ -dim angular-momentum algebra  $SO(d, 2) = SO(p + 1, 2) = SO(2n, 2)$ .

The Noncommutative Poisson brackets ( NCPB ) are defined by

$$\Omega(q^m, q^n) = \{q^m, q^n\}_{NCPB} = \lim_{\hbar_{eff} \rightarrow 0} \frac{1}{i\hbar_{eff}} [q^m, q^n] = -\frac{L^2}{\hbar} \Sigma^{mn}. \quad (4.5a)$$

$$\Omega(p^m, p^n) = \{p^m, p^n\}_{NCPB} = \lim_{\hbar_{eff} \rightarrow 0} \frac{1}{i\hbar_{eff}} [p^m, p^n] = -\frac{\hbar}{L^2} \Sigma^{mn} \quad (4.5b)$$

$$\Omega(q^m, p^n) = -\Omega(p^n, q^m) = \{q^m, p^n\}_{NCPB} = \lim_{\hbar_{eff} \rightarrow 0} \frac{1}{i\hbar_{eff}} [q^m, p^n] = -\eta^{mn}. \quad (4.5c)$$

where  $\Sigma^{mn}$  above is the "classical"  $\hbar_{eff} = (\hbar L_P/R) \rightarrow 0$  limit ( $R \rightarrow \infty$ ,  $L_P \rightarrow 0$ ,  $RL_P = L^2$ ,  $\hbar \neq 0$ ) of the quantity  $\Sigma^{mn} = \frac{1}{\hbar}(X^m P^n - X^n P^m)$ , after embedding the  $d - 1$  dimensional spacetime ( boundary of  $AdS_d$  ) into an ordinary  $(d - 1) + 2$ -dimensional one. In the  $R \rightarrow \infty, \dots$  limit, the  $AdS_d$  space ( the hyperboloid ) degenerates into a *flat* Minkowski spacetime and the coordinates  $q^m, p^n$ , in that infrared limit, *coincide* with the coordinates  $X^m, P^n$ . Concluding, in the "classical" limit ( $R \rightarrow \infty, \dots$ , flat limit ) one has

$$\Sigma^{mn} \equiv \frac{1}{\hbar}(X^m P^n - X^n P^m) \rightarrow \frac{1}{\hbar}(q^m p^n - q^n p^m). \quad (4.5d)$$

and then one recovers in that limit the ordinary definition of the angular momentum in terms of commuting coordinates  $q$ 's and commuting momenta  $p$ 's.

Denoting the coordinates  $(q^m, p^m)$  by  $Z^m$  and when the Poisson structure  $\Omega^{mn}$  is given in terms of *constant* numerical coefficients, the Moyal star product is defined in terms of the deformation parameter  $\hbar_{eff} = \hbar L_P/R$  as

$$(\mathcal{F} * \mathcal{G})(z) \equiv \exp [ (i\hbar_{eff}) \Omega^{mn} \partial_m^{(z_1)} \partial_n^{(z_2)} ] \mathcal{F}(z_1) \mathcal{G}(z_2)|_{z_1=z_2=z}. \quad (4.6)$$

where the derivatives  $\partial_m^{(z_1)}$  act only on the  $\mathcal{F}(z_1)$  term and  $\partial_n^{(z_2)}$  act only on the  $\mathcal{G}(z_2)$  term. In our case the generalized Poisson structure  $\Omega^{mn}$  is given in terms of *variable* coefficients, it is a function of the coordinates, then  $\partial \Omega^{mn} \neq 0$ , since the Yang's algebra is basically an angular momentum algebra, therefore the suitable Moyal-Yang star product given by Kontsevich [?] will contain the appropriate *corrections*  $\partial \Omega^{mn}$  to the ordinary Moyal star product

Denoting by  $\partial_m = \partial/\partial z^m = (\partial/\partial q^m; \partial/\partial p^m)$  the Moyal-Yang-Kontsevich star product, let us say, of the Hamiltonian  $H(q, p)$  with the density distribution in phase space  $\rho(q, p)$  (not necessarily positive definite),  $H(q, p) * \rho(q, p)$  is

$$H\rho + i\hbar_{eff} \Omega^{mn} (\partial_m H \partial_n \rho) + \frac{(i\hbar_{eff})^2}{2} \Omega^{m_1 n_1} \Omega^{m_2 n_2} (\partial_{m_1 m_2}^2 H) (\partial_{n_1 n_2}^2 \rho) + \frac{(i\hbar_{eff})^2}{3} [\Omega^{m_1 n_1} (\partial_{n_1} \Omega^{m_2 n_2}) (\partial_{m_1} \partial_{n_2} H \partial_{n_2} \rho - \partial_{m_2} H \partial_{m_1} \partial_{n_2} \rho)] + O(\hbar_{eff}^3). \quad (4.7)$$

where the explicit components of  $\Omega^{mn}$  are given by eqs-(4-5a-4-5d). The Kontsevich star product is associative up to second order [?]  $(f * g) * h = f * (g * h) + O(\hbar_{eff}^3)$ .

The most general expression of the Kontsevich star product in Poisson manifolds is quite elaborate and shall not be given here. Star products in *curved* phase spaces have been constructed by Fedosov [?]. Despite these technical subtleties it did not affect the final expressions for the "classical" Noncommutative p-brane actions as shown in [?] when one takes the  $\hbar_{eff} \rightarrow 0$  "classical" limit. In that limit there are still *nontrivial noncommutative corrections* to the ordinary p-brane actions.

In the Weyl-Wigner-Gronewold-Moyal quantization scheme in phase spaces one writes

$$H(x, p) * \rho(x, p) = \rho(x, p) * H(x, p) = E\rho(x, p). \quad (4.8)$$

where the Wigner density function in phase space associated with the Hilbert space state  $|\Psi\rangle$  is

$$\rho(x, p, \hbar) = \frac{1}{2\pi} \int dy \Psi^*(x - \frac{\hbar y}{2}) \Psi(x + \frac{\hbar y}{2}) e^{ipy/\hbar} \quad (4.9)$$

plus their higher dimensional generalizations. It remains to be studied if this Weyl-Wigner-Gronewold-Moyal quantization scheme is appropriate to study QM over Noncommutative Yang's spacetimes when we use the above Moyal-Yang-Kontsevich star products. A recent study of the Yang's Noncommutative algebra and *discrete* Hilbert (Buniy-Hsu-Zee) spaces was undertaken by Tanaka [?].

Let us write down the Moyal-Yang-Kontsevich star deformations of the Field theory Lagrangian corresponding to the scalar field  $\Phi = \Phi(X^{AB})$  which depends on the holographic-area coordinates  $X^{AB}$  [?]. The reason one should *not* try to construct the star product of  $\Phi(x^m) * \Phi(x^n)$  based on the Moyal-Yang-Kontsevich product, is because the latter star product given by eq-(4-7) will introduce explicit *momentum* terms in the r.h.s of  $\Phi(x^m) * \Phi(x^n)$ , stemming from the expression  $\Sigma^{mn} = x^m p^n - x^n p^m$  of eq-(4-5d), and thus it invalidates writing  $\phi = \phi(x)$  in the first place. If the  $\Sigma^{mn}$  were *numerical constants*, like  $\Theta^{mn}$ , then one could write the  $\Phi(x^m) * \Phi(x^n)$  in a straightforward fashion as it is done in the literature.

The reason behind choosing  $\Phi = \Phi(X^{AB})$  is more clear after one invokes the area-coordinates and angular momentum correspondence discussed in detail in



section 2 . It allows to properly define the star products. A typical Lagrangian is of the form

$$\begin{aligned} \mathcal{L} = & - \Phi * \partial_{X^{AB}}^2 \Phi(X^{AB}) + \frac{m^2}{2} \Phi(X^{AB}) * \Phi(X^{AB}) + \\ & \frac{g^n}{n} \Phi(X^{AB}) * \Phi(X^{AB}) * \dots * \Phi(X^{AB}). \end{aligned} \quad (4.10)$$

and leads to the equations of motion

$$\begin{aligned} -(\partial/\partial X^{AB}) (\partial/\partial X^{AB}) \Phi(X^{AB}) + m^2 \Phi(X^{AB}) + \\ g^n \Phi(X^{AB}) * \Phi(X^{AB}) * \dots * \Phi(X^{AB}) = 0. \end{aligned} \quad (4.11)$$

when the multi-symplectic  $\Omega^{ABCD}$  form is coordinate-independent, the star product is

$$\begin{aligned} (\Phi * \Phi)(Z^{AB}) & \equiv \exp [ (i\lambda \Omega^{ABCD} \partial_{X^{AB}} \partial_{Y^{AB}}) ] \Phi(X^{AB}) \Phi(Y^{AB})|_{X=Y=Z} \\ & = \exp [ ( \Sigma^{ABCD} \partial_{X^{AB}} \partial_{Y^{AB}} ) ] \Phi(X^{AB}) \Phi(Y^{AB})|_{X=Y=Z} \end{aligned} \quad (4.12)$$

where  $\Sigma^{ABCD}$  is derived from the structure constants of the holographic area-coordinate algebra in C-spaces [?]

$$[X^{AB}, X^{CD}] = \Sigma^{ABCD} \equiv iL_P^2 (\eta^{AD} X^{BC} - \eta^{AC} X^{BD} + \eta^{BC} X^{AD} - \eta^{BD} X^{AC}). \quad (4.13)$$

there are nontrivial derivative terms acting on  $\Sigma^{ABCD}$  in the definition of the star product  $(\Phi * \Phi)(Z^{MN})$  as we have seen in the definition of the Kontsevich star product  $H(x, p) * \rho(x, p)$  in eq-(4-7) . The expansion parameter in the star product is the Planck scale squared  $\lambda = L_P^2$ . The star product has the same functional form as (4-7) with the only difference that now we are taking derivatives w.r.t the area-coordinates  $X^{AB}$  instead of derivatives w.r.t the variables  $x, p$ , hence to order  $O(L_P^4)$ , the star product is

$$\begin{aligned} \Phi * \Phi = & \Phi^2 + \Sigma^{ABCD} (\partial_{AB} \Phi \partial_{CD} \Phi) + \\ & \frac{1}{2} \Sigma^{A_1 B_1 C_1 D_1} \Sigma^{A_2 B_2 C_2 D_2} (\partial_{A_1 B_1 A_2 B_2}^2 \Phi) (\partial_{C_1 D_1 C_2 D_2}^2 \Phi) + \\ & \frac{1}{3} [ \Sigma^{A_1 B_1 C_1 D_1} (\partial_{C_1 D_1} \Sigma^{A_2 B_2 C_2 D_2}) (\partial_{A_1 B_1} \partial_{A_2 B_2} \Phi \partial_{C_2 D_2} \Phi - B_1 \leftrightarrow B_2) ]. \end{aligned} \quad (4.14)$$

Notice that the powers of  $iL_P^2$  are encoded in the definition of  $\Sigma^{ABCD}$ . The star product is noncommutative but is also nonassociative at the order  $O(L_P^6)$  and beyond. The Jacobi identities would be anomalous at that order and beyond. The derivatives acting on  $\Sigma^{ABCD}$  are

$$\begin{aligned} (\partial_{C_1 D_1} \Sigma^{A_2 B_2 C_2 D_2}) = & iL_P^2 (\eta^{A_2 D_2} \delta_{C_1 D_1}^{B_2 C_2} - \eta^{A_2 C_2} \delta_{C_1 D_1}^{B_2 D_2}) + \\ & iL_P^2 (\eta^{B_2 C_2} \delta_{C_1 D_1}^{A_2 D_2} - \eta^{B_2 D_2} \delta_{C_1 D_1}^{A_2 C_2}). \end{aligned} \quad (4.15)$$

where  $\delta_{CD}^{AB} = \delta_C^A \delta_D^B - \delta_D^A \delta_C^B$  and the higher derivatives like  $\partial_{A_1 B_1 C_1 D_1}^2 \Sigma^{A_2 B_2 C_2 D_2}$  will be zero.

## 5 On the Generalized Dirac-Konstant Equation in Clifford Spaces

To conclude this work we will discuss the wave equations relevant to fermions. The "square" of the Dirac-Konstant equation

$$(\gamma^{[\mu\nu]}\Sigma_{\mu\nu})\Psi = \lambda\Psi. \quad (5.1)$$

yields

$$(\gamma^{[\mu\nu]}\gamma^{[\rho\tau]}\Sigma_{\mu\nu}\Sigma_{\rho\tau})\Psi = \lambda^2\Psi \Rightarrow$$

$$[\gamma^{[\mu\nu\rho\tau]} + (\eta^{\mu\rho}\gamma^{[\nu\tau]} - \eta^{\mu\tau}\gamma^{[\nu\rho]} + \dots) + (\eta^{\mu\rho}\eta^{\nu\tau}\mathbf{1} - \eta^{\mu\tau}\eta^{\nu\rho}\mathbf{1})] \Sigma_{\mu\nu}\Sigma_{\rho\tau} \Psi = \lambda^2\Psi. \quad (5.2)$$

where we omitted numerical factors. The generalized Dirac equation in Clifford spaces is given by [?]

$$-i\left(\frac{\partial}{\partial\sigma} + \gamma^\mu \frac{\partial}{\partial x^\mu} + \gamma^{[\mu\nu]} \frac{\partial}{\partial x^{\mu\nu}} + \dots + \gamma^{[\mu_1\mu_2\dots\mu_d]} \frac{\partial}{\partial x^{\mu_1\mu_2\dots\mu_d}}\right) \Psi = \lambda\Psi. \quad (5.3)$$

where  $\sigma, x^\mu, x^{\mu\nu}, \dots$  are the generalized coordinates associated with the Clifford *polyvector* in C-space

$$X = \sigma\mathbf{1} + \gamma^\mu x_\mu + \gamma^{\mu_1\mu_2} x_{\mu_1\mu_2} + \dots + \gamma^{\mu_1\mu_2\dots\mu_d} x_{\mu_1\mu_2\dots\mu_d}. \quad (5.4)$$

after the length scale expansion parameter is set to unity. The generalized Dirac-Konstant equations in Clifford-spaces are obtained after introducing the generalized angular momentum operators [?]

$$\Sigma^{[\mu_1\mu_2\dots\mu_n][\nu_1\nu_2\dots\nu_n]} =$$

$$X^{[\mu_1\mu_2\dots\mu_n]} P^{[\nu_1\nu_2\dots\nu_n]} = X^{[\mu_1\mu_2\dots\mu_n]} i(\partial/\partial X_{[\nu_1\nu_2\dots\nu_n]}) -$$

$$X^{[\nu_1\nu_2\dots\nu_n]} i(\partial/\partial X_{[\mu_1\mu_2\dots\mu_n]}). \quad (5.5)$$

by writing

$$\sum_n \gamma^{[\mu_1\mu_2\dots\mu_n]}\gamma^{[\nu_1\nu_2\dots\nu_n]} \Sigma^{[\mu_1\mu_2\dots\mu_n][\nu_1\nu_2\dots\nu_n]} \Psi = \lambda\Psi. \quad (5.6)$$

and where we sum over all polyvector-valued indices (antisymmetric tensors of arbitrary rank) . Upon squaring eq-(5-5), one obtains the Clifford space extensions of the *D0*-brane field equations found in [?] which are of the form

$$[X^{AB}(\partial/\partial X_{CD}) - X^{CD}(\partial/\partial X_{AB})][X_{AB}(\partial/\partial X^{CD}) - X_{CD}(\partial/\partial X^{AB})] \Psi = 0. \quad (5.6)$$

where  $A, B = 1, 2, \dots, 6$ . It is warranted to study all these equations in future work and their relation to the physics of *D*-branes and Matrix Models [?]. Yang's Noncommutative algebra should be extended to superspaces, meaning non-anti-commuting Grassmanian coordinates and noncommuting bosonic coordinates.

### Acknowledgments

We are indebted to C. Handy and M.Bowers for encouragement and support.

## References

- [1] C.N Yang, Phys. Rev **72** ( 1947 ) 874. Proceedings of the International Conference on Elementary Particles, ( 1965 ) Kyoto, pp. 322-323.
- [2] S. Snyder: Phys. Rev. **71** (1947) 38. Phys. Rev. **71** (1947) 78.
- [3] S.Tanaka, Nuovo Cimento **114 B** (1999) 49. "Contracted Representation of Yang's Spacetime Algebra and Buniy-Hsu-Zee Discrete Spacetime " hep-th/0511023. " Noncommutative Field Theory on Yang's Space-Time Algebra, Covariant Moyal Star products and Matrix Model " hep-th/0406166 . " Space-Time Quantization and Nonlocal Field Theory ..." hep-th/0002001 . "Yang's Quantized Space-Time Algebra and Holographic Hypothesis " hep-th/0303105 .
- [4] A. Ashtekar, C. Rovelli and L. Smolin, Phys. Rev. Lett **69** (1992) 237.
- [5] -C. Castro, Mod. Phys. Letts **A 17** , No. 32 (2002) 2095. ( 2004 ) .
- [6] C. Castro, "Branes from Moyal deformations of Generalized Yang-Mills Theories" [arXiv: hep-th/9908115]. S. Ansoldi, C. Castro, E. Spallucci, Phys. Lett **B 504** ( 2001 ) 174 . Class. Quan. Gravity **18** ( 2001) L17-L23. Class. Quan. Gravity **18** ( 2001) 2865 . S. Ansoldi, C. Castro, E. Guendelman and E. Spallucci, Class. Quant. Gravity vol. 19 ( 2002 ) L 135.
- [7] C. Castro, General Relativity and Gravitation **36** , No. 12 (2004) 2605.
- [8] C. Castro, Jour. Math. Phys. **34** (1993) 681. Phys Letts **B 288** (1992) 291.
- [9] Q.H. Park, Int. Jour. Mod. Phys **A 7** ( 1992) 1415. H. Garcia-Compean, J. Plebanski, M. Przanowski, "Geometry associated with SDYM and chiral approaches to Self Dual Gravity" [ arXiv : hep-th/9702046] .
- [10] J. Hoppe, " Quantum Theory of a Relativistic Surface" Ph.D Thesis MIT (1982).
- [11] M. Kontsevich, " Deformation Quantization on Poisson Manifolds I " q-alg/9709040.
- [12] B. Fedosov, J. Diff. Geom **40** , no. 2 (1994 ) 213.
- [13] C. Castro and M. Pavsic, Progress in Physics, vol. **1** ( 2005 ) 31-64 .
- [14] C. Castro, Foundations of Physics **35** , no. 6 (2005) 971.
- [15] C.Castro, Phys. Letts **B 626** (2005) 209. Foundations of Physics **8** ( 2000 ) 1301.
- [16] T. Biro, B. Mueller and S. Matinyan, " Chaotic Quantization: maybe the Lord plays dice after all ?" hep-th/0301131.

- [17] O. Aharony, S. Gubser, J. Maldacena, H. Ooguri and Y. Oz, " Phys. Rep **323** (2000) 183.
- [18] B. de Witt and I. Herger, " Anti de Sitter Supersymmetry" hep-th/9908005.

# RUNNING NEWTONIAN COUPLING AND HORIZONLESS SOLUTIONS IN QUANTUM EINSTEIN GRAVITY

C. Castro\*<sup>1</sup>, J. A. Nieto\*<sup>2</sup>, J.F. Gonzalez†<sup>3</sup>

\*Center for Theoretical Studies of Physical Systems, Clark Atlanta University, Atlanta, GA. 30314, USA.

\*Facultad de Ciencias Físico-Matemáticas de la Universidad Autónoma de Sinaloa, 80010, Culiacán Sinaloa, México.

November 2006

## Abstract

It is shown how the exact Nonperturbative Renormalization Group flow of the running Newtonian coupling  $G(r)$  in Quantum Einstein Gravity is consistent with the existence of an ultra-violet cutoff  $R(r=0) = 2G_N M_o$  in the most general Schwarzschild solutions. After setting  $g_{tt} = 1 - 2G_N M_o/R(r) = 1 - 2G(r)M(r)/r$ , and due to the condition  $G(r=0) = 0$  and  $M(r=0) \sim 1/2G_N M_o$ , we prove why there is *no* horizon, since  $g_{tt}(r=0) = 0$ , and there is a delta function scalar curvature singularity at  $r=0$ . Similar results follow in generalized Anti de Sitter-Schwarzschild metrics with a running cosmological parameter  $\Lambda(r)$  and Newtonian coupling  $G(r)$ . The ultra-violet cutoff in this latter case is no longer given by  $2G_N M_o$ , but instead is given by a real-valued positive root  $R_*$  of a cubic equation associated with the condition  $g_{tt}(R(r=0)) = g_{tt}(R_*) = 0$ . A running Newtonian coupling  $G(r)$  can also be accommodated naturally in a Jordan-Brans-Dicke scalar-tensor theory of Gravity via a trivial conformal transformation of the Schwarzschild metric. However, the running Newtonian coupling  $G(r) = (16\pi\Phi^2)^{-1}$  corresponding to the scalar field  $\Phi$  does not satisfy the asymptotic freedom condition  $G(r=0) = 0$  associated with the ultra-violet non-Gaussian fixed point of Nonperturbative Quantum Einstein Gravity. Nevertheless, our results exhibit an interesting ultra-violet/infrared *duality* behaviour of  $G(r)$  that warrants further investigation. Some final remarks are added pertaining naked singularities in higher derivative gravity, Finsler geometry, metrics in phase spaces and the connection between an ultra-violet cutoff in Noncommutative spacetimes and the general Schwarzschild solutions.

Keywords: Renormalization Group, Quantum Gravity, General Relativity, Strings, Black Holes. **PACS** numbers: 04.60.-m, 04.65.+e, 11.15.-q, 11.30.Ly

---

<sup>1</sup>castro@ctsps.cau.edu

<sup>2</sup>nieto@uas.uasnet.mx

<sup>3</sup>jfgh.teorfizikisto@gmail.com

# 1 Renormalization Group Flow and Schwarzschild solution

## 1.1 Introduction

We begin by writing down the class of static spherically symmetric (SSS) solutions of Einstein's equations [1] studied by [5], [8], [7], [6] among others, and most recently [12] given by a *infinite* family of solutions parametrized by a family of admissible radial functions  $R(r)$

$$(ds)^2 = g_{00} (dt)^2 - g_{RR} (dR)^2 - R^2 (d\Omega)^2 = g_{00} (dt)^2 - g_{RR} \left(\frac{dR}{dr}\right)^2 (dr)^2 - R^2 (d\Omega)^2 = g_{00} (dt)^2 - g_{rr} (dr)^2 - (R(r))^2 (d\Omega)^2 \quad (1.1a)$$

where the solid angle infinitesimal element is

$$(d\Omega)^2 = \sin^2(\phi)(d\theta)^2 + (d\phi)^2. \quad (1.1b)$$

and

$$g_{00} = \left(1 - \frac{2 G_N M_o}{R(r)}\right); \quad g_{RR} = \frac{1}{g_{00}} = \frac{1}{1 - (2 G_N M_o/R(r))}. \\ g_{rr} = g_{RR} (dR/dr)^2 = \left(1 - \frac{2 G_N M_o}{R(r)}\right)^{-1} \left(\frac{dR(r)}{dr}\right)^2. \quad (1.1c)$$

Notice that the static spherically symmetric (SSS) vacuum solutions of Einstein's equations, with and without a cosmological constant, do *not* determine the form of the radial function  $R(r)$  [12], [10]. There are two classes of solutions; ( i ) those solutions whose radial functions obey the condition  $R(r=0) = 0$ , like the Hilbert textbook black hole solution  $R(r) = r$  with a horizon at  $r = 2G_N M_o$ ; and ( ii ) those horizonless solutions with an ultraviolet cutoff  $R(r=0) = 2G_N M_o$ . In particular, for radial functions like

$$R(r) = r + 2G_N M_o; \quad R(r) = [r^3 + (2G_N M_o)^3]^{1/3}; \quad R(r) = \frac{2G_N M_o}{1 - e^{-2G_N M_o/r}}. \quad (1.2)$$

found by Brillouin [3] , Schwarzschild [2] and Fiziev-Manev [7] respectively obeying the conditions that  $R(r=0) = 2G_N M_o$  and when  $r \gg 2G_N M_o \Rightarrow R(r) \rightarrow r$ .

It is very important to emphasize that despite the fact that one can always *relabel* the variable  $r$  for  $R$  in such a way that the metric in eq-(1.1) has exactly the *same functional form* as the standard Hilbert textbook solution [4] (black-holes solutions with a horizon at  $r = 2G_N M_o$ ) this does *not* mean that the Hilbert textbook metric is *diffeomorphic* to the metric in eq-(1.1). The reason is that the values of  $r$  range from 0 to  $\infty$  while the values of  $R$  range from  $2G_N M_o$  to  $\infty$ . The physical explanation why there is an ultra-violet cutoff at  $R = 2G_N M_o$  was provided long ago by Abrams [5], and rather than imposing this ultraviolet ( UV ) cutoff  $R = 2G_N M_o$  by fiat

(by decree, by hand) there is a deep physical reason for doing so; namely it has been argued that the Hilbert textbook solution  $R(r) = r$  does not properly represent the *static* gravitational field of a point mass centered at the origin  $r = 0$  [5], [7], [8], [6] because the Hilbert textbook solution is not *static* in the region  $0 < r < 2G_N M_o$  after performing the Fronsdal-Kruskal-Szekeres analytical continuation in terms of the new  $u, v$  coordinates.

In section **3** we will explain the physical meaning of this UV cutoff  $R(r = 0) = 2G_N M_o$  resulting from the noncommutativity of the spacetime coordinates. Since the point  $r = 0$  is fuzzy and delocalized, it has an area. Another interpretation as to why the proper area of the point mass at  $r = 0$  is not zero ( while the volume is zero ) may be due to the *stringy* nature of a "point" and can be understood if one formulates the problem in *phase space*, in particular within the framework of the Finsler geometry associated with the co-tangent bundle of spacetime. Thus a nonzero area of the point mass at  $r = 0$  stems from the additional momentum degrees of freedom in phase space after imposing the mass-shell condition  $p_\mu p^\mu = M^2$ .

There are many *physical* differences among the Hilbert textbook solution that has a horizon at  $r = 2G_N M_o$  and the original 1916 Schwarzschild's *horizonless* solution [2]. The Schwarzschild 1916 solution is *not* a naive radial reparametrization of the Hilbert solution because the radial function chosen by Schwarzschild  $R^3 = |r|^3 + (2G_N M_o)^3$  can *never zero*. The absolute value  $|r|$  properly accounts for the field of a point mass source located at  $r = 0$ . Thus, the lower bound of  $R$  is given by  $2G_N M_o$ , and  $R$  cannot be zero for a nonvanishing point mass source.

The Fronsdal-Kruskal-Szekeres analytical continuation of the Hilbert textbook solution for  $r < 2G_N M_o$  yields a *spacelike* singularity at  $r = 0$  and the roles of  $t$  and  $r$  are interchanged when one crosses  $r = 2G_N M_o$ ; so the interior region  $r < 2G_N M_o$  is *no* longer *static*. The Schwarzschild solution is *static* for all values of  $r$  and in particular for  $r < 2G_N M_o$ ; there is *no* horizon at  $r = 2G_N M_o$  and there is a *timelike* naked singularity at  $r = 0$ , the true location of the point mass source. Notice that when  $r \gg 2G_N M_o$  the Schwarzschild solution reduces to the Hilbert solution and one has the correct Newtonian limit.

Colombeau [11] developed the rigorous mathematical treatment of tensor-valued distributions in General Relativity, new generalized functions (nonlinear distributional geometry) and multiplication of distributions in *nonlinear* theories like General Relativity since the the standard Schwarz theory of linear distributions is invalid in nonlinear theories. This treatment is essential in order to understand the physical singularity at the point-mass location  $r = 0$ . In [10] we studied the many subtleties behind the introduction of a true point-mass source at  $r = 0$  ( that couples to the vacuum field ) and the physical consequences of the delta function singularity (of the scalar curvature) at the location of the point mass source  $r = 0$ . Those solutions were obtained from the vacuum SSS solutions simply by replacing  $r$  for  $|r|$ . For instance, the Laplacian in spherical coordinates in flat space of  $1/|r|$  is equal to  $-(1/r^2)\delta(r)$ , but the Laplacian of  $1/r$  is *zero*. Thus, to account for the presence of a true mass-point source at  $r = 0$  one must use solutions depending on the modulus  $|r|$  instead of  $r$ .

One can have an infinite number of metrics parametrized by a family of arbitrary radial functions  $R(r)$  with the desired behaviour at  $r = 0$  and  $r = \infty$ , whose values for

the scalar curvature (parametrized by a family of arbitrary radial functions  $R(r)$ ) are given by [10]

$$\mathcal{R} = -\frac{2 G_N M_o \delta(r)}{R^2 (dR/dr)}; \text{ in units of } c = 1. \quad (1.3a)$$

Since the scalar curvature  $\mathcal{R}$  (1.3a) is a *coordinate invariant* quantity, this result in eq-(1.3a) that depends explicitly on the family of radial functions  $R(r)$  corroborates once more that one cannot view the role of the radial function  $R(r)$  as a naive change of radial coordinates from  $r$  to  $R$ . Hence, one must view the radial function squared  $R^2(r)$  as just one of the *metric* tensor-field components  $g_{\phi\phi}(r) \equiv R^2(r)$ ; i.e.  $R(r)^2$  is a *function* of the radial coordinate  $r$  that has a lower cutoff given by  $g_{\phi\phi}(r=0) = (2G_N M_o)^2$ . One must not confuse  $R$  with  $r$  and even after relabeling  $r$  for  $R$ , the metric in eq-(1.1) is *not* diffeomorphic to the Hilbert textbook solution due to the cutoff  $R = 2G_N M_o$ . If one chooses the radial functions to obey the condition  $R(r=0) = 0$  and  $R(r \rightarrow \infty) \sim r$  then only in this case these metrics are diffeomorphic to the Hilbert textbook black hole solution.

The relevant *invariant* physical quantity *independent* of the any *arbitrary* choice of  $R(r)$  is the Einstein-Hilbert action, whether it obeys the condition  $R(r=0) = 0$  or  $R(r=0) = 2G_N M_o$ . In particular, the Euclideanized action after a compactification of the temporal interval yields an invariant quantity which is precisely equal to the "black hole" entropy in Planck area units. The invariant area is the proper area at  $r=0$  given by  $4\pi R(r=0)^2 = 4\pi(2G_N M_o)^2$ . We shall see that the source of entropy is due entirely to the scalar curvature delta function singularity at the location of the point mass source given by  $\mathcal{R} = -[2G_N M_o/R^2(dR/dr)]\delta(r)$  [10] after using the 4-dim measure  $4\pi R^2 (|g_{RR}|^{1/2} dR) (|g_{tt}|^{1/2} dt) = 4\pi R^2 dR dt$  in the Euclidean Einstein-Hilbert action.

Therefore, the Einstein-Hilbert action associated with the scalar curvature delta function in eq-(1.3a) when the four-dim measure is

$$d^4x = 4\pi R^2 dR dt. \quad (1.3b)$$

is

$$S = -\frac{1}{16\pi G_N} \int (4\pi R^2 dR dt) \left(-\frac{2M \delta(r)}{R^2 (dR/dr)}\right) = \frac{1}{16\pi G_N} \int \left(\frac{2G_N M_o}{r^2} \delta(r)\right) (4\pi r^2 dr dt). \quad (1.3c)$$

Notice that the action (1.3c) is truly *invariant* and *independent* of any *arbitrary* choice of the radial function  $R(r)$ , whether or not it is the Hilbert textbook choice  $R(r) = r$ , or any other choice for  $R(r)$ . The Euclideanized action (1.3c) becomes, after reinserting the Newtonian coupling  $G = L_{Planck}^2$  in order to have the proper units,

$$S(Euclidean) = \frac{4\pi(G_N M_o)^2}{G_N} = \frac{4\pi (2G_N M_o)^2}{4 L_{Planck}^2} = \frac{Area}{4 L_{Planck}^2}. \quad (1.3d)$$

when the Euclidean time coordinate interval  $2\pi t_E$  is defined in terms of the Hawking temperature  $T_H$  and Boltzman constant  $k_B$  as  $2\pi t_E = (1/k_B T_H) = 8\pi G_N M_o$ . It is



interesting that the Euclidean action (1.3c) is the same as the "black hole" entropy (1.3d) in Planck area units. The source of entropy is due entirely to the scalar curvature delta function singularity at the location of the point mass source. Furthermore, this result that the Euclidean action is equal to the entropy in Planck units can be generalized to higher dimensions upon recurring to Schwarzschild-like metrics in higher dimensions.

The fact that a point-mass can have a non-zero *proper area*  $4\pi R(r = 0)^2 = 4\pi(2G_N M_o)^2$ , but no volume, due to the metric and curvature singularity at  $r = 0$  seems to indicate a *stringy* nature underlying the very notion of a point-mass itself. The string world-sheet has a non-zero area but zero volume. Aspinwall [13] has studied how a string (an extended object) can probe space-time points due to the breakdown of our ordinary concepts of Topology at small scales. In [12] it was shown how the Bars-Witten *stringy* 1 + 1-dim black-hole metric [14] can be embedded into the 4-dim *conformally* re-scaled metrics displayed in eq-(1.1), if and only if, the radial function  $R(r)$  was given implicitly by the following relationship involving  $R$  and  $r$  ( the left hand side has the same functional form as the radial tortoise coordinate) :

$$\int \frac{dR}{1 - 2G_N M_o/R} = R + 2G_N M_o \ln \left( \frac{R - 2G_N M_o}{2M_o} \right) = 2G_N M_o \ln \left[ \sinh \frac{r}{2G_N M_o} \right]. \quad (1.4a)$$

one can verify that there is an ultra-violet cutoff at  $r = 0$

$$R(r = 0) = 2G_N M_o; \quad R(r \rightarrow \infty) \rightarrow R \sim r. \quad (1.4b)$$

which *precisely* has the same behaviour at  $r = 0$  and  $\infty$  as the radial functions displayed in this section. The fact that the stringy black-hole 1 + 1-dim solution can be embedded into the conformally rescaled solutions of this section, for a very specific functional form of the radial function  $R(r)$ , with the same "boundary" conditions at  $r = 0$  and  $r = \infty$  as the radial functions displayed in this section, is very appealing. Similar conclusions apply to horizonless solutions in higher dimensions  $D > 4$  [12] with a cutoff  $R(r = 0) = [16\pi G_D M_o / (D - 2)\Omega_{D-2}]^{1/D-3}$  where the point-mass has a nonzero  $D - 2$ -dimensional measure and a zero  $D - 1$ -dim "volume". The point-mass in this case is *p-branelike* in nature with  $p + 1 = D - 2$ . For example, in  $D = 5$  one has a membrane-like behaviour of a point mass. In  $D = 6$  one has a 3-brane-like behaviour of a point mass, etc.... The  $D = 4$  case is special since it corresponds to the string.

## 1.2 Renormalization Group Flow and Horizonless Solutions

The purpose of this section is to explain the meaning of the ultra-violet cutoff  $R(r = 0) = 2G_N M_o$  within the context of the exact Nonperturbative Renormalization Group flow of the Newtonian coupling  $G = G(r)$  in Quantum Einstein Gravity [16] where a non-Gaussian ultra-violet fixed point was found  $G(r = 0) = 0$ . The presence of an ultra-violet cutoff  $R = 2G_N M_o$  originates from the mere presence of matter and permits to relate the metric component  $g_{tt} = 1 - 2G_N M_o/R(r)$  to  $g_{tt} = 1 - 2G(r)M(r)/r$ , in such a way

that the the small distance behaviour of  $G(r)$  *eliminates* the presence of a horizon at  $r = 2G_N M_o$  : we will see why the metric component  $g_{tt}$  evaluated at the location of the point mass source  $r = 0$  is  $g_{tt}(r = 0) = 0$ , due to  $G(r = 0) = 0, M(r = 0) = finite$  but it does *not* eliminate the delta function singularity of the scalar curvature at  $r = 0$ . This result is compatible with the ultra-violet cutoff of the radial function  $R(r = 0) = 2G_N M$ .  $G_N$  is the value of the Newtonian coupling in the deep infrared and  $M = M_o$  is the Kepler mass as seen by an observer at asymptotic infinity.

The momentum dependence of  $G(k^2)$  was found by Reuter et al [16] to be

$$G(k^2) = \frac{G_N}{1 + \alpha G_N k^2}. \quad (1.5a)$$

The momentum-scale relationship is defined

$$k^2 = \left(\frac{\beta}{D(R)}\right)^2, \quad \beta = constant. \quad (1.5b)$$

in terms of the proper radial distance  $D(R)$

$$D(R) = \int_{2G_N M_o}^R \sqrt{g_{RR}} dR = \int_{2G_N M_o}^R \frac{dR}{\sqrt{1 - (2 G_N M_o/R)}} = \sqrt{R ( R - 2 G_N M_o)} + 2 G_N M_o \ln \left[ \sqrt{\frac{R}{2G_N M_o}} + \sqrt{\frac{R - 2G_N M_o}{2G_N M_o}} \right]. \quad (1.6)$$

where the lower (ultra-violet cutoff ) is  $R(r = 0) = 2G_N M_o$ . The proper distance corresponding to  $r = 0$  is  $D(R(r = 0)) = D(R = 2G_N M_o) = 0$  as it should since the proper distance from  $r = 0$  is zero when one is located at  $r = 0$ .

Hence,

$$G = G(R) = \frac{G_N}{1 + \alpha G_N k^2} = \frac{G_N D(R)^2}{D(R)^2 + \alpha \beta^2 G_N}, \quad (1.7)$$

such that  $G(R(r = 0)) = G(R = 2G_N M_o) = 0$  consistent with the findings [16] since  $D(R(r = 0)) = D(R = 2G_N M_o) = 0$ .

An important remark is in order. There is a *fundamental difference* between the work of Reuter et al [16] and ours . The metric components studied by [16] were of the form,  $g_{tt} = 1 - 2G(r)M_o/r, \dots$  and are *not* solutions of Einstein's field equations. Whereas in our case, the metric components (1.1)  $g_{tt} = 1 - 2G(r)M(r)/r = 1 - 2G_N M_o/R(r), \dots$  *are* solutions of Einstein' equations displayed in eq-(1.1). This is one of the most salient features in working with the most general metric (1.1) involving the radial functions  $R(r)$  instead of forcing  $R(r) = r$ .

Hence, given that  $R = R(r)$ , by imposing the following conditions valid for *all* values of  $r$

$$\left(1 - \frac{2 G_N M_o}{R(r)}\right) = \left(1 - \frac{2 G(r) M(r)}{r}\right). \quad (1.8)$$

$$\frac{\left(\frac{dR}{dr}\right)^2}{\left(1 - \frac{2G_N M_o}{R(r)}\right)} = \frac{1}{\left(1 - \frac{2G(r) M(r)}{r}\right)}. \quad (1.9)$$

from eqs-(1.7, 1.8, 1.9) one infers that

$$\frac{dR}{dr} = 1 \Rightarrow R(r) = r + 2G_N M_o. \quad (1.10)$$

which is the Brillouin choice for the radial function as well as the relation

$$G(r) = G_N \left(\frac{r}{R}\right) \left(\frac{M_o}{M(r)}\right) = \left(\frac{G_N D(R)^2}{D(R)^2 + \alpha\beta^2 G_N}\right) \Rightarrow$$

$$M(r) = M_o \left(\frac{r}{R}\right) \left(\frac{D(R)^2 + \alpha\beta^2 G_N}{D(R)^2}\right). \quad (1.11)$$

that allows us to determine the form of the  $M(r)$  once the radial function  $R(r) = r + 2G_N M_o$  is plugged into  $D(R)$  given by eq-(1.6). The constant found by Reuter et al [16] is  $\alpha\beta^2 = 118/15\pi$  and the proper distance  $D(R)$  is given by eq-(1.6).

When  $r = 0$  a careful analysis reveals

$$M(r \rightarrow 0) \rightarrow (\text{constant}) \frac{1}{2G_N M_o}. \quad (1.12)$$

therefore, the running mass parameter at  $r = 0$ ,  $M(r = 0) \sim 1/R(r = 0) = 1/(2G_N M_o)$  is *finite* instead of being infinite. The running mass at  $r = 0$  has a cutoff given by the inverse of the ultra-violet cutoff  $R(r = 0) = 2G_N M_o$  ( up to a numerical constant ). When  $r = 0$  one has in eqs-(1.7, 1.11) that  $G(r = 0) = 0$ . When  $r \rightarrow \infty$  one has  $M(r \rightarrow \infty) \rightarrow M_o$  as expected, where  $M_o$  is the Kepler mass observed by an observer at asymptotic infinity ( deep infrared ) and  $G(r \rightarrow \infty) \rightarrow G_N$ .

The running flow  $M(r)$  was never studied by [16]. Our ansatz in eqs-(1.8, 1.9) is an heuristic one ( a conjecture ). In the special case when  $M(r = 0) = M_o$  one gets the interesting result for the value of  $M_o$  given by  $M_o \sim M_{Planck}$  which is the same, up to a trivial numerical factor, to the Planck mass remnant in the final state of the Hawking black hole evaporation process found by [16] after a Renormalization Group improvement of the Vaidya metric was performed.

Concluding,  $R = r + 2G_N M_o$  is the sought after relation between  $r$  and  $R$ , out of an infinite number of possible functions  $R(r)$  obeying the SSS vacuum solutions of Einstein's equations. We may notice that  $r = r(R) = D(R)$  given by eq-(1.6) is the appropriate choice for the radial function if, and only if, the *spatial* area coincides with the *proper* area  $4\pi R(r)^2$ . The spatial area  $A(r)$  is determined in terms of the infinitesimal spatial volume  $dV(r)$  as follows :

$$dV(r) = A(r)dr \Rightarrow A(r) = 4\pi R(r)^2 \frac{(dR/dr)}{\sqrt{1 - 2G_N M_o/R(r)}}. \quad (1.13a)$$

When  $A(r) = 4\pi R^2$  then

$$\frac{(dR/dr)}{\sqrt{1 - 2G_N M_o/R}} = 1. \quad (1.13b)$$

since the integration of eq-(1.12) was performed in eq-(1.6), one can infer then that  $r = r(R) = D(R)$  is the choice in this case for the functional relationship between  $R$  and  $r$ ; in particular  $A(r = 0) = 4\pi(2G_N M_o)^2$ , which is not true in general when the *proper* area is not equal to the *spatial* area. The volume is *zero* at  $r = 0$ .

To finalize this subsection, when the radial function  $R = r + 2G_N M_o$  has been specified by the RG flow solutions [16] , the scalar curvature is

$$\mathcal{R} = -\frac{2 G_N M_o \delta(r)}{R^2 (dR/dr)} = -\frac{2 G_N M_o \delta(r)}{(r + 2G_N M_o)^2}. \quad (1.14a)$$

and has a delta function singularity at  $r = 0$  of the form

$$-\frac{2 G_N M_o \delta(r = 0)}{(2G_N M_o)^2} = -\frac{\delta(r = 0)}{2G_N M_o}. \quad (1.14b)$$

compared to the *stronger* singular behaviour of the Hilbert textbook solution at  $r = 0$  when  $R = r$

$$\begin{aligned} \mathcal{R}(\text{Hilbert}) &= -\frac{2 G_N M_o \delta(r)}{R^2 (dR/dr)} = -\frac{2 G_N M_o \delta(r)}{r^2} \Rightarrow \\ \mathcal{R}(r = 0) &= -\frac{2 G_N M_o \delta(r = 0)}{0^2}. \end{aligned} \quad (1.14c)$$

The reason the singularity of (1.14b) is softer than in (1.14c) is because when there is an ultra-violet cutoff of the radial function  $R(r = 0) = 2G_N M_o$  (due to the presence of matter) the proper area  $4\pi(2G_N M_o)^2$  is finite at  $r = 0$  and so is the surface mass density. However, since the *volume* is *zero* at the location  $r = 0$  of the point-mass, the volume mass density is *infinite* and one cannot eliminate the singularity at  $r = 0$  given by  $\mathcal{R} = -\delta(r = 0)/(2G_N M_o)$  .

### 1.3 Anti de Sitter-Schwarzschild Metrics and running Cosmological Constant

We begin with the generalized de Sitter and Anti de Sitter metrics that will help us understand the nature of the infrared cutoff required to solve the cosmological constant problem. In [10] we proved why the most general *static* form of the ( Anti ) de Sitter-Schwarzschild solutions are given in terms of an arbitrary radial function by

$$g_{00} = \left( 1 - \frac{2G_N M_o}{R(r)} - \frac{\Lambda_o}{3} R(r)^2 \right), \quad g_{rr} = -\left( 1 - \frac{2G_N M_o}{R(r)} - \frac{\Lambda_o}{3} R(r)^2 \right)^{-1} (dR(r)/dr)^2. \quad (1.15)$$

The angular part is given as usual in terms of the solid angle by  $-(R(r))^2(d\Omega)^2$ .

$\Lambda_o$  is the cosmological constant. The  $\Lambda_o < 0$  case corresponds to Anti de Sitter-Schwarzschild solution and  $\Lambda_o > 0$  corresponds to the de Sitter-Schwarzschild solution. The physical interpretation of these solutions is that they correspond to "black holes" in curved backgrounds that are not asymptotically flat. For very small values of  $R$  one recovers the ordinary Schwarzschild solution. For very large values of  $R$  one recovers asymptotically the ( Anti ) de Sitter backgrounds of constant scalar curvature.

Since the radial function  $R(r)$  can be arbitrary, one particular expression for the radial function  $R(r)$ , out of an *infinite* number of arbitrary expressions, in the de Sitter-Schwarzschild ( $\Lambda_o > 0$ ) case one may choose [10]

$$\frac{1}{R - (2G_N M_o)} = \frac{1}{r} + \sqrt{\frac{\Lambda_o}{3}}. \quad (1.16)$$

When  $\Lambda_o = 0$  one recovers  $R = r + (2G_N M_o)$  that has a similar behaviour at  $r = 0$  and  $r = \infty$  as the original Schwarzschild solution of 1916 given by  $R^3 = r^3 + (2G_N M_o)^3$ ; i.e.  $R(r = 0) = 2G_N M_o$  and  $R(r \rightarrow \infty) \sim r$  respectively. When  $M_o = 0$  one recovers the pure de Sitter case and the radial function becomes

$$\frac{1}{R} = \frac{1}{r} + \sqrt{\frac{\Lambda_o}{3}}. \quad (1.17)$$

In this case, one encounters the *reciprocal* situation ( the "dual" picture ) of the Schwarzschild solutions : ( i ) when  $r$  tends to zero ( instead of  $r = \infty$  ) the radial function behaves  $R(r \rightarrow 0) \rightarrow r$  ; in particular  $R(r = 0) = 0$  and (ii) when  $r = \infty$  ( instead of  $r = 0$  ) the value of  $R(r = \infty) = R_{Horizon} = \sqrt{\frac{3}{\Lambda_o}}$  and one reaches the location of the *horizon* given by the condition  $g_{00}[R(r = \infty)] = 0$ .

A reasonable and plausible argument as to why the cosmological constant is not *zero* and why it is so *tiny* was given by [10] : In the pure de Sitter case, the condition

$$g_{00}(r = \infty) = 0 \Rightarrow 1 - \frac{\Lambda_o}{3} R(r = \infty)^2 = 0 \quad (1.18)$$

has a real valued solution

$$R(r = \infty) = \sqrt{\frac{3}{\Lambda_o}} = R_{Horizon} = \text{Infrared cutoff}. \quad (1.19)$$

and the correct order of magnitude of the observed cosmological constant can be derived from eq-(1.19) by equating  $R(r = \infty) = R_{Horizon} =$  Hubble Horizon radius as seen today since the Hubble radius is *constant* in the very *late time* pure inflationary de Sitter phase of the evolution of the universe when the Hubble parameter is constant  $H_o$ . The metric in eq-(1.15) is the *static* form of the generalized de Sitter ( Anti de Sitter ) metric associated with a *constant* Hubble parameter.

Therefore, by setting the Hubble radius to be of the order of  $10^{61} L_{Planck}$  and by setting  $G = L_{Planck}^2$  (  $\hbar = c = 1$  units ) in

$$8\pi G \rho_{vacuum} = \Lambda_o = \frac{3}{R(r = \infty)^2} = \frac{3}{R_H^2} \Rightarrow$$

$$\rho_{vacuum} = \frac{3}{8\pi} \frac{1}{L_P^2} \frac{1}{R_H^2} = \frac{3}{8\pi} \frac{1}{L_P^4} \left(\frac{L_P}{R_H}\right)^2 \sim 10^{-123} (M_{Planck})^4, \quad (1.20)$$

we obtain a result which agrees with the experimental observations when  $R_{Hubble} \sim 10^{61} L_{Planck}$ .

Notice the importance of using the radial function  $R = R(r)$  in eq-(1.17). Had one used  $R = r$  in eq-(1.17) one would have obtained a *zero* value for the cosmological constant when  $r = \infty$ . Thus, the presence of the radial function  $R(r)$  is essential to understand *why* the cosmological constant is not *zero* and why it is so *tiny*.

The idea now is to relate the metric components in the Anti de Sitter-Schwarzschild case involving the *running*  $G(r), M(r), \Lambda(r)$  parameters with the metric components of (1.15) involving the unique and sough-after radial function  $R(r)$  and the constants  $G_N, M_o, \Lambda_o$  (as seen by an asymptotic observer in the deep infrared region). The equations which determine the forms of  $M(r)$  and  $R(r)$  are given by

$$\left(1 - \frac{2 G_N M_o}{R(r)} - \frac{\Lambda_o}{3} R(r)^2\right) = \left(1 - \frac{2 G(r) M(r)}{r} - \frac{\Lambda(r)}{3} r^2\right). \quad (1.21)$$

$$\left(1 - \frac{2 G_N M_o}{R(r)} - \frac{\Lambda_o}{3} R(r)^2\right)^{-1} (dR(r)/dr)^2 = \left(1 - \frac{2G(r) M(r)}{r} - \frac{\Lambda(r)}{3} r^2\right)^{-1}. \quad (1.22)$$

then from eqs-(1.21, 1.22) one infers that

$$\frac{dR}{dr} = 1 \Rightarrow R(r) = r + R_* \quad (1.23)$$

where the constant of integration  $R_*$  is now the root of the cubic equation, and *not* the value  $2G_N M_o$ , given by

$$1 - \frac{2 G_N M_o}{R(r=0)} + \frac{\Lambda_o}{3} R(r=0)^2 = 1 - \frac{2 G_N M_o}{R_*} + \frac{\Lambda_o}{3} R_*^2 = 0. \quad (1.24)$$

such that  $g_{tt}(R(r=0)) = g_{tt}(R_*) = 0$ . The real positive root of the cubic equation (found after multiplying (1.24) by  $R_* \neq 0$ ) is

$$R_* = \left[ \frac{3G_N M_o}{|\Lambda_o|} + \sqrt{\frac{(3G_N M_o)^2}{\Lambda_o^2} + \frac{1}{|\Lambda_o|^3}} \right]^{1/3} + \left[ \frac{3G_N M_o}{|\Lambda_o|} - \sqrt{\frac{(3G_N M_o)^2}{\Lambda_o^2} + \frac{1}{|\Lambda_o|^3}} \right]^{1/3}. \quad (1.25)$$

Because Anti de Sitter space has  $\Lambda_{AdS} < 0$ , we have already taken into account the negative sign in the expression in eq-(1.25) by writing  $\Lambda_{AdS} = -|\Lambda_o|$  and we must disregard the two complex roots (a pair of complex conjugates).

The values of  $R$  range from  $0 < R_* \leq R \leq \infty$  and correspond to the values of  $r$  ranging from  $0 \leq r \leq \infty$ . This is very reasonable since  $R$  has an ultra-violet cutoff given by the root of the cubic  $R_* > 0$ . If  $R$  was allowed to attain the values of *zero* the metric component  $g_{tt}$  would blow up.  $r$  can in fact attain the *zero* value, but not the

radial function  $R(r) = r + R_*$ . The metric component  $g_{rr}$  in (1.15) blows up at  $r = 0$ , location of the singularity.

Notice that one cannot take the limits  $\Lambda_0 \rightarrow 0$  in eq-(1.25) *after* having found the roots of the cubic equation because that limit is singular. One must take the limit  $|\Lambda_o| \rightarrow 0$  of eq-(1.24) before and afterwards find the root of  $g_{tt}(R_*) = 0$  given by  $R_* = 2G_N M_o$  (when  $|\Lambda_o| = 0$ ).

After having found the root  $R_*$  of the cubic equation, from eq-(1.21) one infers

$$\frac{2 G_N M_o}{r + R_*} + \frac{\Lambda_o}{3} (r + R_*)^2 = \frac{2 G(r) M(r)}{r} + \frac{\Lambda(r)}{3} r^2. \quad (1.26)$$

which yields  $M(r)$

$$M(r) = \frac{r}{2G(r)} \left[ \frac{2G_N M_o}{r + R_*} + \frac{\Lambda_o}{3} (r + R_*)^2 - \frac{\Lambda(r)}{3} r^2 \right]. \quad (1.27)$$

where now the proper distance  $D(R)$  associated with the metric (1.15) is given the *elliptic* integral whose lower limit of integration is now given by the cubic root  $R_*$  (instead of  $2G_N M_o$ ) :

$$D(R) = \int_{R_*}^R \sqrt{g_{RR}} dR = \int_{R_*}^R \frac{dR}{\sqrt{1 - \frac{2 G_N M_o}{R} + \frac{|\Lambda_o|}{3} R^2}} = \textit{Elliptic Integral}. \quad (1.28a)$$

such

$$D(R(r=0)) = D(R = R_*) = 0. \quad (1.28b)$$

The running coupling is the one given by [16]

$$G = G(R) = \frac{G_N}{1 + \alpha G_N k^2} = \frac{G_N D(R)^2}{D(R)^2 + \alpha \beta^2 G_N}. \quad (1.29)$$

where  $D(R)$  is given by the elliptic integral and the running cosmological parameter is [16]

$$|\Lambda(k)| = |\Lambda_o| + \frac{b G_N}{4} (k^4) = |\Lambda_o| + \frac{b G_N}{4} \frac{\beta^4}{D(R)^4}. \quad (1.30)$$

where the momentum-scale relation is  $k^2 = (\beta^2/D(R)^2)$  .

As expected, in eq-(1.27) we have the correct limits :  $M(r \rightarrow \infty) \rightarrow M_o$ , since when  $r \rightarrow \infty$ ,  $R(r) \rightarrow r$ ,  $|\Lambda(r)| \rightarrow |\Lambda_o|$  and  $G(r) \rightarrow G_N$ .  $M(r=0) \sim 1/R_*$  is finite also because  $r/G(r)$  and  $\Lambda(r)r^2$  are *finite* as  $r \rightarrow 0$ .

In the case of de Sitter-Schwarzschild metric ,  $\Lambda_o > 0$ , one has a negative real root and a positive double root [10]  $R_2 = R_3 > 0$ ,  $R_1 < 0$ ; however, there is *no* horizon since  $g_{tt}$  does not change signs as once crosses the double-root location ; there is problem with the  $R_1 < 0$  solutions and there is a pole of  $g_{tt}$  at  $R = 0$  . For this reason we have focused on the Anti de Sitter-Schwarzschild metric in this subsection.

## 2 Jordan-Brans-Dicke Gravity

We wish now to relate the metric of eq-(1.1) that solves the vacuum Einstein field equations for  $r > 0$  written in terms of  $G_N, M_o, R(r)$  with a metric written in terms of  $G(r), M(r), r$  that does *not* solve the vacuum field equations but instead the field equations in the presence of a scalar field  $\Phi$  associated with the Jordan-Brans-Dicke theory of gravity. Such metric is given by

$$(ds)^2 = g_{tt}(r) (dt)^2 - g_{rr}(r) (dr)^2 - \rho(r)^2 (d\Omega)^2. \quad (2.1)$$

A conformal transformation  $g'_{\mu\nu} = e^{2\lambda} g_{\mu\nu}$  relating the two metrics can be attained by starting with the Brans-Dicke-Jordan scalar-tensor action

$$\int d^4x \sqrt{g} [ \Phi^2 \mathcal{R} + 6 (\nabla_\mu \Phi) (\nabla^\mu \Phi) ]. \quad (2.2)$$

and which can be transformed into a pure gravity action by means of a conformal transformation

$$g'_{\mu\nu} = e^{2\lambda} g_{\mu\nu}; \quad \sqrt{g'} = e^{4\lambda} \sqrt{g}. \quad (2.3)$$

$$\sqrt{g'} \mathcal{R}'(g') = \sqrt{g} e^{2\lambda} [ \mathcal{R} - 6 (\nabla_\mu \nabla^\mu \lambda) - 6 (\nabla_\mu \lambda)(\nabla^\mu \lambda) ] \quad (2.4)$$

By setting

$$e^{2\lambda} \equiv \frac{\Phi^2}{\Phi_o^2} = \frac{G_N}{G(r)}. \quad (2.5)$$

one can rewrite :

$$\sqrt{g'} \mathcal{R}'(g') = \frac{\sqrt{g}}{\Phi_o^2} [ \Phi^2 \mathcal{R} - 6 \Phi (\nabla_\mu \nabla^\mu \Phi) ] \quad (2.6)$$

due to the fact that  $(\nabla_\mu \sqrt{g}) = 0$  then

$$\sqrt{g} \Phi (\nabla_\mu \nabla^\mu \Phi) = \nabla_\mu (\sqrt{g} \Phi \nabla^\mu \Phi) - \sqrt{g} (\nabla_\mu \Phi)(\nabla^\mu \Phi). \quad (2.7)$$

since total derivative term drops from the action one has the equalities

$$\begin{aligned} \int d^4x \sqrt{g} [ \Phi^2 \mathcal{R} + 6 (\nabla_\mu \Phi) (\nabla^\mu \Phi) ] &= \int d^4x \sqrt{g} [ \Phi^2 \mathcal{R} - 6 \Phi (\nabla_\mu \nabla^\mu \Phi) ] = \\ &= \frac{1}{16\pi G_N} \int d^4x \sqrt{g'} \mathcal{R}'(g') \end{aligned} \quad (2.8)$$

therefore, one can solve the Einstein vacuum field equations for the metric  $g'_{\mu\nu}$  ( for  $r > 0$  ) and perform a conformal transformation  $g'_{\mu\nu} = e^{2\lambda} g_{\mu\nu}$  to obtain the metric that solves the field equations corresponding to the Jordan-Brans-Dicke action.



The running Newtonian coupling  $G(r)$  is now defined explicitly in terms of the scalar field as follows

$$\Phi^2 = \frac{1}{16\pi G(r)}; \quad \Phi_o^2 = \frac{1}{16\pi G_N}. \quad (2.9a)$$

and the dimensionless scaling factor  $e^{2\lambda}$  is given by the ratio :

$$e^{2\lambda} = \frac{G_N}{G(r)} = \frac{\Phi^2}{\Phi_o^2}. \quad (2.9b)$$

such that the equalities among the three lines of eq-(2.5) are satisfied.

The scalar field  $\Phi$  that determines the functional form of  $G(r)$  must solve the generalized Klein-Gordon equation obtained from a variation of the action (2.5) w.r.t the scalar field  $\Phi$

$$(\nabla_\mu \nabla^\mu - \frac{1}{6}\mathcal{R}) \Phi = 0, \quad for \ r > 0. \quad (2.10)$$

and the latter equation is *equivalent* to the equation  $\mathcal{R}'(g') = 0$  since the scalar curvature  $\mathcal{R}$ , for  $r > 0$ , is fixed by eq-(2.6) after setting  $\mathcal{R}'(g') = 0$  because the metric  $g'_{\mu\nu}$  is a solution of the Einstein vacuum field equations for  $r > 0$ . When  $\mathcal{R}'(g') = 0$ , for  $r > 0$ , yields the scalar curvature

$$\mathcal{R}(g) = \frac{6}{\Phi} (\nabla_\mu \nabla^\mu \Phi). \quad (2.11)$$

which is precisely *equivalent* to the generalized Klein-Gordon equation (2.10). This means that the scalar  $\Phi$  field does not have dynamical degrees of freedom since it is identified with the conformal factor  $e^\lambda = \Phi/\Phi_o$ . Therefore one can safely equate the scalar field  $\Phi^2$  with  $(1/16\pi G(r))$  giving

$$\begin{aligned} \mathcal{R}(r) &= \frac{6}{\Phi} (\nabla_r \nabla^r \Phi) = \\ &= \frac{6}{\sqrt{G(r)}} \frac{1}{\sqrt{g}} \partial_r (\sqrt{g} g^{rr} \partial_r \sqrt{G(r)}). \end{aligned} \quad (2.12)$$

where the metric components  $g_{\mu\nu}$  necessary to evaluate the Laplace-Beltrami operator are obtained directly via the conformal scaling of the metric that solves the vacuum static spherical solutions of Einstein's equations of the previous section :

$$g_{tt} = e^{-2\lambda} \left(1 - \frac{2G_N M_o}{R(r)}\right). \quad (2.13)$$

$$g_{RR} = e^{-2\lambda} \frac{1}{1 - \frac{2G_N M_o}{R}}, \quad g_{rr} = g_{RR} (dR/dr)^2. \quad (2.14)$$

$$g_{\phi\phi} = e^{-2\lambda} R(r)^2 = \rho(r)^2, \quad g_{\theta\theta} = e^{-2\lambda} R(r)^2 \sin^2(\phi). \quad (2.15)$$

$$\sqrt{g} = e^{-4\lambda} R(r)^2 (dR/dr) \sin(\phi). \quad (2.16)$$

Since  $e^{-2\lambda} = G(r)/G_N$  and  $G(r=0) = 0$  then the radial *rho* function obeys the condition  $\rho(r=0) = 0$ .

The new proper distance  $D(R)$  is now given by

$$D(R) = \int_{2G_N M_o}^R \frac{e^{-\lambda}}{\sqrt{1 - (2G_N M_o/R)}} dR = \int_{2G_N M_o}^R \frac{(G(R)/G_N)^{1/2}}{\sqrt{1 - (2G_N M_o/R)}} dR \quad (2.17)$$

and *differs* from the expressions of eq-(1.6) because of the conformal factor.

However, there is a *caveat* if we now try to use the running flow of the Newtonian coupling of the previous section [16]

$$G(R) = \frac{G_N D(R)^2}{D(R)^2 + \alpha\beta^2 G_N} \Rightarrow D(R) = \sqrt{\frac{(\alpha\beta^2 G_N) G(R)}{G_N - G(R)}}. \quad (2.18)$$

because the RG flow equations *must differ* now due to the *presence* of the scalar field  $\Phi$ . To prove why one *cannot* use the running flow equation (2.18) for  $G$  used in section **1.2, 1.3**, let us differentiate both sides of the expression for  $D(R)$  in eq-(2.18) and upon equating the result with the integrand of eq-(2.17) leads to the *differential* equation obeyed by  $G(R)$  :

$$\frac{dD(R)}{dR} = \frac{\alpha\beta^2 G_N^2}{2 (G_N - G(R))^2 \sqrt{\frac{(\alpha\beta^2 G_N) G(R)}{G_N - G(R)}}} \frac{dG(R)}{dR} = \frac{(G(R)/G_N)^{1/2}}{\sqrt{1 - (2G_N M_o/R)}}. \quad (2.19)$$

subject to the boundary conditions  $G(R(r=0)) = G(R = 2G_N M_o) = 0$  and  $G(r \rightarrow \infty) = G(R \rightarrow \infty) \rightarrow G_N$ . The differential equation (2.19) *is* the equation that determines the functional form of  $G(R)$ . Notice that functional form of  $G(R)$  which obeys the above differential equation is *not* the same as the result obtained for  $G(R)$  in eq-(1.7) of the previous section because the proper distance  $D(R)$  given by the integral of eq-(2.17) *differs* from the integral of eq-(1.6). The constant found by Reuter et al [16] is  $\alpha\beta^2 = 118/15\pi$ .

One can integrate eq-(2.19) giving the functional relationship between  $G$  and  $R$  :

$$\begin{aligned} \frac{\sqrt{\alpha\beta^2} G_N^2}{2} \int_{G_o}^G \frac{dG}{G \sqrt{(G_N - G)^3}} &= \int_{2G_N M_o}^R \frac{dR}{\sqrt{1 - (2G_N M_o/R)}} = \\ \frac{\sqrt{\alpha\beta^2} G_N^2}{2} \left[ \frac{2}{G_N \sqrt{(G_N - G)}} - \frac{2 \operatorname{arctanh} [\sqrt{1 - (G/G_N)}]}{(G_N)^{3/2}} \right] - I[G_o] &= \\ \sqrt{R (R - 2 G_N M_o)} + 2 G_N M_o \ln \left[ \sqrt{\frac{R}{2G_N M_o}} + \sqrt{\frac{R - 2G_N M_o}{2G_N M_o}} \right]. \end{aligned} \quad (2.20)$$

where  $G_o \equiv G(R = 2G_N M_o)$ .

One can immediately deduce that the first integral *diverges* when  $G = G_N$  which is compatible with the condition  $G(R \rightarrow \infty) = G_N$ . But there is a problem in enforcing the

behaviour of  $G(r = 0) = 0$ ; one cannot impose the condition  $G_o \equiv G(R = 2G_N M_o) = 0$  because the  $G$  integral also *diverges* when  $G = G_o = 0$  ! ( the integral is  $-\infty$  ). Therefore, one must have the condition  $G_o \equiv G(R = 2G_N M_o) \neq 0$ . The value of  $G_o$  obeying  $G_N > G_o = G(r = 0) > 0$  can be determined from solving the transcendental equation derived from the condition

$$I[G_o] = \frac{\sqrt{\alpha\beta^2} G_N^2}{2} \left[ \frac{2}{G_N \sqrt{(G_N - G_o)}} - \frac{2 \operatorname{arctanh} \left[ \sqrt{1 - (G_o/G_N)} \right]}{(G_N)^{3/2}} \right] = 0. \quad (2.21)$$

The result  $I[G_o] = 0$  is now compatible with the behaviour of the  $R$  integral which is *zero* when  $R(r = 0) = 2G_N M_o$ . To sum up : one *cannot* satisfy the condition  $G(R(r = 0)) = 0$  required by eqs-(1.7, 2.18) found by [16].

The same conclusions apply ( one is forced to impose  $G_o > 0$  ) if we had taken a *minus* sign in front of the square root in the  $R$  integral which leads to  $G(r \rightarrow \infty) = 0$  (  $R \sim r$  when  $r \rightarrow \infty$  ), as opposed to the desired behaviour  $G(r \rightarrow \infty) \rightarrow G_N$ . It is interesting that this result  $G(r \rightarrow \infty) = 0$ , when the minus sign in front of the square root is chosen, is "dual" to the behaviour found in the RG flow solutions by [16] where at  $r = 0$  (instead of  $r = \infty$  ) one encounters  $G(R(r = 0)) = G(R = 2G_N M_o) = 0$  ( asymptotic freedom).

Concluding, the fact that  $G$  integral (2.20) *diverges* at  $G = 0$  is a signal that one *cannot* use the running flow equation (2.18) for  $G$  in the presence of the Jordan-Brans-Dicke scalar  $\Phi$ . One would have to solve the *modified* RG equations that will involve the *beta* functions for the  $\Phi$  field in addition to the metric  $g_{\mu\nu}$ . A similar *divergence* problem was encountered by [17]. One can bypass this divergence problem by imposing  $G(r = 0) = G(R = 2G_N M_o) = G_o > 0$  where  $G_o$  is given by a solution of the transcendental equation. By taking the minus sign in front of the square root we found an ultraviolet/infrared "duality" behaviour of the couplings, at  $r = 0$  and  $R \sim r \rightarrow \infty$ , which warrants further investigation.

### 3 Concluding Remarks : On Noncommutative and Finsler Geometries

We conclude by discussing some speculative remarks. It is well known (see references in [17]) that by replacing  $G_N \rightarrow G(k^2) = G_N(1 + G_N k^2)^{-1}$  leads to  $1/k^4$  modifications of the propagator

$$\frac{G(k^2)}{k^2} = \frac{G_N}{k^2 (1 + G_N k^2)} = G_N \left[ \frac{1}{k^2} - \frac{1}{k^2 + M_{Planck}^2} \right], \quad G_N M_{Planck}^2 = 1. \quad (3.1)$$

that correspond to quadratic curvatures  $\mathcal{R}^2$  of perturbative quantum gravity. The Lanczos-Lovelock theories of Gravity involving higher powers of the curvature have the attractive feature that the equations of motion are no more than second order in derivatives

of the metric and contain no ghosts. The authors [18] have found black hole solutions, topological defects, and naked singularities as well, in pure Lanczos-Lovelock Gravity with only one Euler density term. The fact that naked singularities were found by [18] deserve further investigation within the context of modified propagators induced by a running Newtonian coupling.

Another interesting field of study is Noncommutative Geometry, Fuzzy spaces, Fractal geometries, etc... The standard noncommutative algebra ( there are far more fundamental algebras like Yang's algebra in noncommutative phase spaces ) is of the form

$$[x^\mu, x^\nu] = i\Theta^{\mu\nu}. \quad [p^\mu, p^\nu] = 0 \quad [x^\mu, p^\nu] = i\eta^{\mu\nu} \quad (3.2)$$

where  $\eta^{\mu\nu}$  is a flat space metric and the structure constants (c-numbers)  $\Theta^{\mu\nu} = -\Theta^{\nu\mu}$  are c-numbers that commute with  $x, p$  and that have dimensions of  $length^2$ ; the  $\Theta^{\mu\nu}$  are proportional to the  $L_{Planck}^2$ . A change of coordinates

$$x'^\mu = x^\mu + \frac{1}{2}\Theta^{\mu\rho} p_\rho. \quad p'^\mu = p^\mu. \quad (3.3)$$

leads to an algebra with commuting coordinates and momenta

$$[x'^\mu, x'^\nu] = 0. \quad [p'^\mu, p'^\nu] = 0. \quad [x'^\mu, p'^\nu] = i\eta^{\mu\nu}. \quad (3.4)$$

Due to the *mixing* of coordinates and momentum in the new commuting variables  $x', p'$  one can envisage coordinate and momentum dependent metrics in phase space, in particular Finsler geometries, and whose average over the momentum coordinates  $\langle \pi_{\mu\nu}(x, p) \rangle_p = g_{\mu\nu}(x)$  yield the effective spacetime metric. This momentum averaging procedure is very similar to the averaging of the momentum-scale dependent metrics employed in the Renormalization Group flow of the effective average action by [16]. Moreover, the momentum dependence of the new coordinates  $x'$  leads to a momentum dependent radial coordinate  $r' = \sqrt{x'^i x'_i}$  involving commuting  $x'^\mu$  coordinates

$$r' = \sqrt{(x^i + \frac{1}{2}\Theta^{i\rho} p_\rho) (x_i + \frac{1}{2}\Theta_{i\tau} p^\tau)}. \quad (3.5)$$

Similar attempts to study the Noncommutative effects on black holes by modifying  $r \rightarrow r'$  have been made by many other authors, [29], [30] however, to our knowledge its relation to phase spaces and Finsler geometries has not been explored. The impending question is to find another interpretation of the radial function  $R(r)$  and the physical meaning of the cutoff  $R(r=0) = 2G_N M_o$  in terms of the momentum dependent radial coordinate  $r'$ .

When  $x^i = 0 \Rightarrow r = 0$  and (3.5) becomes

$$r' = \frac{1}{2}\sqrt{\Theta^{i\rho} p_\rho \Theta_{i\tau} p^\tau}. \quad (3.6)$$

The expression inside the square root can be written in terms of  $p_\mu p^\mu = M_o^2$ , in the *static* case when  $|\vec{p}| = p^i = 0$ ,  $i = 1, 2, 3$ , after the following steps. Firstly, due to the static condition  $p^i = 0$ ,  $p_0 = E = M_o$  one has

$$\Theta^{i\rho} \Theta_{i\tau} p_\rho p^\tau = \Theta^{\mu\rho} \Theta_{\mu\tau} p_\rho p^\tau - \Theta^{0i} \Theta_{0j} p_i p^j = \Theta^{\mu\rho} \Theta_{\mu\tau} p_\rho p^\tau, \quad (3.7)$$

this last expression may be recast as

$$\Theta^{\mu\rho} \Theta_{\mu\tau} p_\rho p^\tau = \lambda p_\tau p^\tau = \lambda M_o^2. \quad (3.8)$$

if, and only if, the  $4 \times 4$  antisymmetric matrix  $\Theta^{\mu\nu}$  obeys the eigenvalue condition :

$$\Theta^{\mu\rho} \Theta_{\mu\tau} p_\rho = \lambda p_\tau. \quad (3.9)$$

In the static case  $p_\rho = (M_o, 0, 0, 0)$ , the eigenvalue condition yields the following 4 conditions

$$\Theta^{\mu 0} \Theta_{\mu 0} p_0 = \lambda p_0, \quad \Theta^{\mu 0} \Theta_{\mu i} p_0 = p_i = 0, \quad i = 1, 2, 3. \quad (3.10)$$

that will restrict the values of the 6 components of the  $4 \times 4$  antisymmetric matrix  $\Theta^{\mu\nu}$ ; i.e. the 6 components are *not* independent.

Therefore, in the *static* case  $p^i = \vec{p} = 0$ , upon imposing the eigenvalue condition and after adjusting the value of the constant  $\lambda = 16 L_{Planck}^4 = 16 G_N^2$ , gives then the ultra-violet cutoff

$$r'(r=0) = \frac{1}{2} \sqrt{\Theta^{i\rho} p_\rho \Theta_{i\tau} p^\tau} = 2 L_P^2 M_o = 2 G_N M_o. \quad (3.11)$$

consistent with  $R(r=0) = 2G_N M_o$  with the only subtlety that that  $r = \sqrt{x^i x_i}$  involves now noncommuting coordinates  $x^\mu$ .

When  $r \neq 0$ , the terms

$$\Theta^{\mu\rho} p_\rho x_\mu + \Theta_{\mu\tau} x^\mu p^\tau = \Theta^{\mu\rho} p_\rho x_\mu + \Theta^{\mu\tau} x_\mu p_\tau =$$

$$\Theta^{\mu\rho} p_\rho x_\mu + \Theta^{\mu\rho} x_\mu p_\rho = \Theta^{\mu\rho} (x_\mu p_\rho - i \eta_{\mu\rho}) + \Theta^{\mu\rho} x_\mu p_\rho = 2 \Theta^{\mu\rho} x_\mu p_\rho. \quad (3.12)$$

due to the antisymmetric property of  $\Theta^{\mu\rho}$ , one has  $\Theta^{\mu\rho} \eta_{\mu\rho} = 0$ .

The quantity  $\Theta^{i\rho} x_i p_\rho$  involving the angular momentum operator,  $x_i p_\rho - x_\rho p_i$  does not preserve the spherical symmetry unless one imposes a condition (constraint) in phase space like

$$\Theta^{i\rho} x_i p_\rho \sim L_{Planck}^2 M_o \omega(r) r^2 = G_N M_o \omega(r) r^2 \quad (3.13)$$

where  $\omega(r)$  is a scale-dependent frequency. Concluding, in the most general case one has :

$$r' = r'(r) = \sqrt{r^2 + 2\Theta^{i\rho} x_i p_\rho + (2G_N M_o)^2}. \quad (3.14)$$

Since eq-(3.14) involves the phase space variables  $x, p$  the question is to see whether or not phase space metrics solutions of the form  $g_{\mu\nu}(x, p) = g_{\mu\nu}(x^\mu + \Theta^{\mu\rho} p_\rho)$  solve the field equations corresponding to Moyal-Fedosov star product deformations of Noncommutative Finsler Gravity associated with the cotangent bundle [20]. For a recent status of Noncommutative Riemannian gravity see [21] and references therein. However, we must believe that it is Finslerian geometry the appropriate one to study and the proper arena to quantize gravity. When  $r = 0$  one recovers the cutoff  $r'(r=0) = 2G_N M_o$ . Therefore this procedure to relate the effects of the Noncommutativity of coordinates with the

ultra-violet cutoff  $R(r = 0) = 2G_N M_o$  is quite promising . We shall leave it for future work.

Let us summarize the main conclusions of this work :

1. The original Schwarzschild's 1916 solution has *no horizons* and is *static* for all values of  $r$  with a timelike naked singularity at  $r = 0$ . The radial function  $R = [r^3 + (2G_N M_o)^3]^{1/3}$  has an UV cutoff in  $R(r = 0) = 2G_N M_o$ .
2. The "black hole" entropy expression is the same as the Euclideanized Einstein-Hilbert action corresponding to the scalar curvature delta function singularity due to the presence of a mass point at the origin  $r = 0$ . Such delta function scalar curvature singularity can *account* for the "black hole" entropy. For this reason a microscopic theory of a point-mass is needed to understand key aspects of Quantum Gravity. A point-mass may be *stringy* in Nature since due to the ultra-violet cutoff  $R(r = 0) = 2G_N M_o$ , a point-mass source at  $r = 0$  has non-zero area but zero volume; a string world-sheet has non-zero area and zero volume.
3. In section **1.2** we showed how the exact Nonperturbative Renormalization Group flow of the running Newtonian coupling  $G(r)$  in Quantum Einstein Gravity [16] was consistent with the existence of an ultra-violet cutoff  $R(r = 0) = 2G_N M_o$  of the Schwarzschild solutions in eq-(1.1), after setting  $g_{tt} = 1 - 2G_N M_o/R(r) = 1 - 2G(r)M(r)/r, \dots$ . We proved that due to the condition  $G(r = 0) = 0$  and  $M(r = 0) \sim 1/2G_N M_o$ , there was *no* horizon since it is at the location  $r = 0$  that  $g_{tt}(r = 0) = 0$ .
4. Similar results followed in the case of Anti de Sitter-Schwarzschild metrics in section **1.3** with a running cosmological parameter  $\Lambda(r)$  and Newtonian coupling  $G(r)$ . The ultra-violet cutoff in this case was no longer given by  $2G_N M_o$  but instead by a real-valued positive root  $R_*$  of the cubic equation associated with the condition  $g_{tt}(R(r = 0)) = g_{tt}(R_*) = 0$ . There was a singularity at  $r = 0$ .
5. Generalized de Sitter metrics led to an *infrared* cutoff  $R(r = \infty) = R_{Hubble} = (3/\Lambda_o)^{1/2}$  in the very late time de Sitter inflationary phase of the evolution of the universe ( when the Hubble parameter is *constant* ) and provided a plausible argument why the cosmological constant is not *zero* and why it is so *tiny* [10].
6. In section **2** we studied how a running Newtonian coupling  $G(r)$  could also be accommodated naturally in a Jordan-Brans-Dicke scalar-tensor theory of Gravity via a trivial conformal transformation of the Schwarzschild metric solution. However, the running Newtonian coupling  $G(r) = (16\pi\Phi^2)^{-1}$  corresponding to the scalar field  $\Phi$  could not satisfy the asymptotic freedom condition  $G(r = 0) = 0$  found by [16]. Nevertheless, our results in section **2** exhibited an interesting ultra-violet/infrared *duality* behaviour of  $G(r)$  that warrants further investigation. A combinatorial geometry and dual nature of gravity was proposed by [19] using Matroid theory.

To finalize we should stress the search for the foundational (quantum equivalence) principle of Quantum Gravity which is related to the true origin of inertia (mass/energy). Mach's principle is an intriguing concept with several formulations and applications [22], [24], [25], [26], [27], [23]. A proper and precise implementation of Mach's principle, beyond the equivalence's principle of General Relativity, in modern physics is still lacking, to our knowledge. Furthermore, it is very likely that our naive notions of Topology break down at small scales [13] and for this reason we must redefine our notion of a "point" such that this novel "fuzzy" topology is compatible with the *stringy geometry*. For the role of Fractals in the construction of a Scale Relativity theory based on scale resolutions of "points" and the minimal Planck scale see [15]. A Phase Space Extended Relativity theory involving an ultra-violet ( minimal scale ) and infrared cutoff ( maximum scale ) in Clifford spaces has been advanced by [27] based on Max Born [28] Reciprocal principle of Relativity in Phase spaces where there is a limiting speed and limiting force (acceleration).

### Acknowledgments

C.C thanks M. Bowers for hospitality. J. A. N. would like to thank to O. Velarde, L. Ruiz and J. Silvas for helpful comments. The work of J.A.N was partially supported by PROFAPI and PIFI 3.2.

### Appendix A

Consider the conformal map

$$g'_{\mu\nu} = e^{2\lambda} g_{\mu\nu}. \quad (A.1)$$

Here, the indices  $\mu, \nu$  run from  $0, 1, \dots, d-1$ . The Christoffel symbols become

$$\Gamma'_{\alpha\beta}{}^{\mu}(g') = \Gamma_{\alpha\beta}{}^{\mu}(g) + \Sigma_{\alpha\beta}^{\mu}, \quad (A.2)$$

where

$$\Sigma_{\alpha\beta}^{\mu} = \delta_{\alpha}^{\mu} \lambda_{,\beta} + \delta_{\beta}^{\mu} \lambda_{,\alpha} - g_{\alpha\beta} \lambda^{;\mu}. \quad (A.3)$$

Using (A.2) one finds that the Riemann tensor can be written as

$$\mathcal{R}'_{\nu\alpha\beta}{}^{\mu}(g') = \mathcal{R}_{\nu\alpha\beta}{}^{\mu}(g) + \nabla_{\alpha} \Sigma_{\nu\beta}^{\mu} - \nabla_{\beta} \Sigma_{\nu\alpha}^{\mu} + \Sigma_{\sigma\alpha}^{\mu} \Sigma_{\nu\beta}^{\sigma} - \Sigma_{\sigma\beta}^{\mu} \Sigma_{\nu\alpha}^{\sigma} \quad (A.4)$$

where  $\nabla_{\alpha}$  denotes covariant derivative in terms of  $\Gamma'_{\alpha\beta}{}^{\mu}(g)$ . By straightforward computation, using (A.3) we find

$$\begin{aligned} \mathcal{R}'_{\nu\alpha\beta}{}^{\mu}(g') &= \mathcal{R}_{\nu\alpha\beta}{}^{\mu}(g) + \{ \delta_{\beta}^{\mu} \nabla_{\alpha} \lambda_{,\nu} - \delta_{\alpha}^{\mu} \nabla_{\beta} \lambda_{,\nu} - g_{\nu\beta} \nabla_{\alpha} \lambda^{;\mu} + g_{\nu\alpha} \nabla_{\beta} \lambda^{;\mu} \} \\ &+ \{ (\delta_{\alpha}^{\mu} \lambda_{,\beta} - \delta_{\beta}^{\mu} \lambda_{,\alpha}) \lambda_{,\nu} - (\delta_{\alpha}^{\mu} g_{\nu\beta} - \delta_{\beta}^{\mu} g_{\nu\alpha}) \lambda_{,\sigma} \lambda^{;\sigma} - (g_{\nu\alpha} \lambda_{,\beta} - g_{\nu\beta} \lambda_{,\alpha}) \lambda^{;\mu} \}. \end{aligned} \quad (A.5)$$

From (A.5) we get the Ricci tensor

$$\begin{aligned}\mathcal{R}'_{\nu\beta}(g') &= \mathcal{R}_{\nu\beta}(g) - \{(d-2)\nabla_{\beta}\lambda_{,\nu} + g_{\nu\beta}\nabla_{\mu}\lambda^{,\mu}\} \\ &\quad + (d-2)\{\lambda_{,\beta}\lambda_{,\nu} - g_{\nu\beta}\lambda_{,\mu}\lambda^{,\mu}\},\end{aligned}\tag{A.6}$$

which in turn gives us the scalar curvature

$$\mathcal{R}' = e^{-2\lambda}\{\mathcal{R} - 2(d-1)\nabla_{\mu}\lambda^{,\mu} - (d-2)(d-1)\lambda_{,\mu}\lambda^{,\mu}\}.\tag{A.7}$$

Therefore we get

$$\sqrt{-g'}\mathcal{R}' = \sqrt{-g}e^{(d-2)\lambda}\{\mathcal{R} - 2(d-1)\nabla_{\mu}\lambda^{,\mu} - (d-2)(d-1)\lambda_{,\mu}\lambda^{,\mu}\}.\tag{A.8}$$

Since  $\nabla_{\mu}\sqrt{-g} = 0$ , (A.8) can also be written as

$$\begin{aligned}\sqrt{-g'}\mathcal{R}' &= \sqrt{-g}e^{(d-2)\lambda}\mathcal{R} - \nabla_{\mu}\left\{\left(\frac{2(d-1)}{d-2}\right)\sqrt{-g}(e^{(d-2)\lambda})_{,\mu}\right\} \\ &\quad + (d-2)(d-1)\sqrt{-g}e^{(d-2)\lambda}\lambda_{,\mu}\lambda^{,\mu}.\end{aligned}\tag{A.9}$$

We observe that the second term is a total derivative and therefore can be dropped. So, we have

$$\sqrt{-g'}\mathcal{R}' = \sqrt{-g}e^{(d-2)\lambda}(\mathcal{R} + (d-2)(d-1)\lambda_{,\mu}\lambda^{,\mu}).\tag{A.10}$$

For  $d = 4$  the expression (A.10) is reduced to

$$\sqrt{-g'}\mathcal{R}' = \sqrt{-g}e^{2\lambda}(\mathcal{R} + 6\lambda_{,\mu}\lambda^{,\mu}).\tag{A.11}$$

Some times it becomes convenient to write  $e^{\lambda} = \Phi$ . In this case, we have  $\lambda_{,\mu} = \Phi^{-1}\Phi_{,\mu}$ . Consequently, we see that (A.11) can also be written as

$$\sqrt{-g'}\mathcal{R}' = \sqrt{-g}(\Phi^2\mathcal{R} + 6\Phi_{,\mu}\Phi^{,\mu})\tag{A.13}$$

or

$$\sqrt{-g'}\mathcal{R}' = \sqrt{-g}(\Phi^2\mathcal{R} + 6\nabla_{\mu}\Phi\nabla^{\mu}\Phi).\tag{A.14}$$

since  $\nabla_{\mu}\Phi = \Phi_{,\mu}$ .

## References

- [1] A. Einstein, *Sitzungsber Preuss Akad Berlin* **II**, 831 (1915).
- [2] K. Schwarzschild, *Sitzungsber Preuss Akad Berlin* **I**, 189 (1916).
- [3] M. Brillouin, *Jour. Phys. Rad* **23** (1923) 43.



- [4] D. Hilbert, *Nachr. Ges. Wiss Gottingen Math. Phys* **K1**, 53 (1917). H. Weyl, *Ann. Physik* **54**, 117 (1917) . J. Droste, *Proc. Ned. Akad. West Ser A* **19**, 197 (1917).
- [5] L. Abrams, *Can. J. of Physics* **67**, 919 (1989). *Physical Review D* **20**, 2474 (1979). *Physical Review D* **21**, 2438 (1980). *Physical Review D* **21**, 2941 (1980) .
- [6] A. Loinger, *On Black Holes and Gravitational Waves* ( La Goliardica Pavese, June 2002 )
- [7] P. Fiziev, "Gravitational field of massive point particle in general relativity", [arXiv.org: gr-qc/0306088]. P. Fiziev and S.V. Dimitrov, "Point electric charge in general relativity" [arXiv.org: hep-th/0406077].
- [8] S. Antoci, D.E. Liebscher, "Reinstating Schwarzschild's original manifold and its singularity" [arXiv.org : gr-qc/0406090].
- [9] C. Fronsdal, *Phys. Rev* **116**, 778 ( 1959) . M. Kruskal, *Phys. Rev* **119** 1743, (1960). G. Szekers, *Publ. Mat. Debrecs* **7**, 285 (1960).
- [10] C.Castro, *Mod. Phys Lett A* **21** , no. 35 (2006) 2685. "On Dark Energy, Weyl's Geometry, Different Derivations of the Vacuum Energy Density and the Pioneer Anomaly", to appear in *Foundations of Physics*.
- [11] J.F. Colombeau, *New generalized functions and multiplication of distributions* (North Holland, Amsterdam, 1984). *Elementary introduction to generalized functions* (North Holland, Amsterdam, 1985). M. Grosser, M. Kunzinger, M. Oberguggenberger and R. Steinbauer, *Geometric theory of generalized functions with applications to relativity*, (Kluwer series on Mathematics and its Applications vol. 537, Kluwer, Dordrecht, 2001). J. Heinzke and R. Steinbauer, *Jour. Math. Phys* **43**, 1493 (2002). "Remarks on the distributional Schwarzschild geometry" [arXiv.org: gr-qc/0112047].
- [12] C. Castro and J. A. Nieto, "On 2+2 spacetimes, strings and black holes" (submitted to *Int. J. Mod. Phys A* , October 2006).
- [13] P. S. Aspinwall, "The Breakdown of Topology at Small Scales" *JHEP* 0407 (2004) 021 (hep-th/0312188). "A Point's Point of View of Stringy Geometry" *JHEP* 0301 (2003) 002 ( hep-th/0203111).
- [14] E. Witten, "On black holes in string theory" Lecture given at Strings '91 Conf., Stony Brook, N.Y., Jun 1991, Published in *Strings: Stony Brook 1991*, 0184-192 (QCD161:S711:1991); hep-th/9111052 I. Bars, Lecture at Strings 91, Stonybrook, June 1991. E. Witten, *Phys. Rev. D* **44**, 314 (1991).
- [15] L. Nottale, *Fractal Spacetime and Microphysics : Towards Scale Relativity* ( World Scientific, Singapore, 1992 )

- [16] A. Bonanno and M. Reuter, "Renormalization group improved black hole spacetime" [arXiv.org : hep-th/0002196]. M. Reuter and J.M. Schwindt, "A Minimal Length from Cutoff Modes in Asymptotically Safe Quantum Gravity" [arXiv.org : hep-th/0511021]. M. Reuter and J.M. Schwindt, "Scale-dependent structures and causal structures in Quantum Einstein Gravity" [arXiv.org:hep-th/0611294]. A.Bonanno, M.Reuter "Spacetime Structure of an Evaporating Black Hole in Quantum Gravity" hep-th/0602159, *Phs. Rev.* **D 73** (2006) 0830005.
- [17] H. Emoto, "Asymptotic safety of quantum gravity and improved spacetime of black hole singularity by cutoff identification" hep-th/0511075
- [18] R.G. Cai and N. Ohta, "Black Holes in Pure Lovelock Gravities" hep-th/0604088. *Phys.Rev. D* **74** (2006) 064001. J. Matyjasek, M. Telecka and D. Tryniecki, "Higher dimensional black holes with a generalized gravitational action" hep-th/0606254 *Phys.Rev. D* **73** (2006) 124016.
- [19] J.A. Nieto, "Matroids and P-branes", *Adv. Theor. Math. Phys.* **8**, 177 (2004); hep-th/0310071. J.A. Nieto and M.C. Marn, "Search for a "gravitoid" theory", *Int. J. Mod. Phys. A* **18**, (2003) 5261; hep-th/0302193.
- [20] S. Vacaru, *Phys. Letts B* **498** (2001) 74. *Jour. Math Phys* **46** (2005) 042503. *Jour. Math Phys* **46** (2005) 032901. *Jour. Math Phys* **47** (2006) 093504. S. Vacaru, P. Stavrinou, E. Gaburov, D. Gonta, *Clifford and Riemann-Finsler Structures in Geometric Mechanics and Gravity*. Geometry Balkan Press, Monograph **7** (2006) 693 pages.
- [21] J. Wess, "Einstein-Riemann Gravity on Deformed Spaces" hep-th/0611025.
- [22] H. Bondi and J. Samuel, "The Lense-Thirring Effect and Mach's Principle" gr-qc/9607009
- [23] F. Wilczek, "Total Relativity", *Physics Today* vol. 57.
- [24] H. Lichtenegger and B. Mashhoon, "Mach's Principle" physics/0407078
- [25] D.F. Roscoe "Clock and rods- or something more fundamental?" physics/0107044.
- [26] V.M. Logunov, "Mach's principle and cosmology term" astro-ph/0210013 "
- [27] C. Castro, *Foundations of Physics*, **35**, no. 6 (2005) 971-1041. "On dual phase-space relativity, the Machian principle and modified newtonian dynamics, *Progress in Physics*, **1** (2006) 20-30.
- [28] M. Born, *Proc. Royal Society A* **165** (1938) 291.
- [29] L. Colatto, A. Penza and W. Santos, "Noncommutative geometry induced by spin effects" [arXiv.org : hep-th/0512266]. F. Nasserri and S. Alavi, "Schwarzschild black hole in Noncommutative spacetime" [arXiv.org: hep-th/0508051.

- [30] A. Lewis, " Coulomb potential of a point mass in theta noncommutative geometry  
" [[arXiv.org:hep-th/0605140](https://arxiv.org/abs/hep-th/0605140)].

# Quantization in Astrophysics and pion condensate

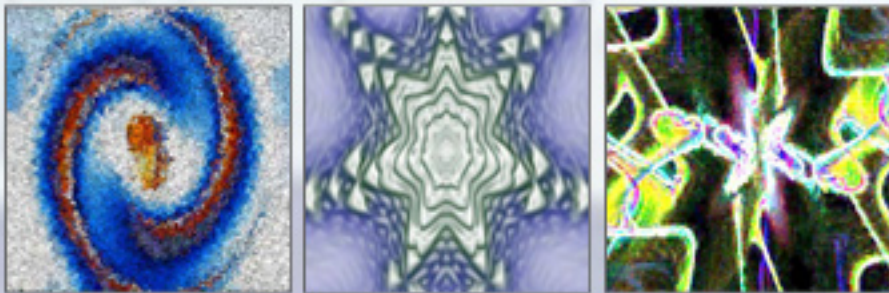

# On the origin of macroquantization in astrophysics and celestial motion

V. CHRISTIANTO<sup>a</sup>

<sup>a</sup>email: vxianto@yahoo.com, <http://reachme.at/coolbit>

Reprinted with kind permission from editor of  
Annales de la Fondation Louis de Broglie

**ABSTRACT.** Despite the use of Bohr radius formula to predict celestial quantization has led to numerous verified observations, the cosmological origin of this macroquantization remains an open question. In this article various plausible approaches are discussed. Further observation to verify or refute this proposition is recommended, in particular for exoplanets.

**RÉSUMÉ:** En dépit de l'utilisation de la formule de rayon de Bohr de prévoir la quantification céleste a mené aux nombreuses observations vérifiées, l'origine cosmologique de ce macroquantization est une question en suspens. En cet article de diverses approches plausibles sont discutées. Promouvez l'observation pour vérifier ou réfuter cette proposition est recommandée, en particulier pour des exoplanets.

## 1 Introduction

It is known that the use of Bohr radius formula [1] to predict celestial quantization has led to numerous verified observations [2][3]. This approach was based on Bohr-Sommerfeld quantization rules [4][5]. Some implications of this quantum-like approach include exoplanets prediction, which has become a rapidly developing subject in recent years [6][7]. While this kind of approach is not widely accepted yet, this could be related to a recent suggestion to reconsider Sommerfeld's conjectures in Quantum Mechanics [8].

While this notion of macroquantization seems making sense at least in the formation era of such celestial objects, i.e. "*all structures in the Universe, from superclusters to planets, had a quantum mechanical origin in its earliest moments*" [9], a question arises as to how to describe the physical origin of wave mechanics of such large-scale structures [5].

A plausible definition of the problem of quantization has been given by Grigorescu [10]: “select an infinite, discrete number of quantum possible real motions, from the continuous manifold of all mechanically possible motions.” While this quantization method has been generally acceptable to describe physical objects at molecular scale, there is not much agreement why shall we also invoke the same notion to describe macrophenomena, such as celestial orbits. Nonetheless, there are plenty efforts in the literature in attempt to predict planetary orbits in terms of wave mechanics, including a generalisation of Keplerian classical orbits [11].

In this article we discuss some plausible approaches available in the literature to describe such macroquantization in astrophysics, in particular to predict celestial motion:

- a. Bohr-Sommerfeld’s conjecture;
- b. Macroquantum condensate, superfluid vortices;
- c. Cosmic turbulence and logarithmic-type interaction;
- d. Topological geometrodynamics (TGD) approach.

While these arguments could be expected to make the notion of macroquantization a bit reasonable, it is beyond the scope of this article to conclude which of the above arguments is the most consistent with the observed data. There is perhaps some linkage between all of these plausible arguments. It is therefore recommended to conduct further research to measure the reliability of these arguments, which seems to be worthwhile in our attempt to construct more precise cosmological theories.

## 2 Bohr-Sommerfeld’s quantization rules

In an attempt to describe atomic orbits of electron, Bohr proposed a conjecture of quantization of orbits using analogy with planetary motion. From this viewpoint, the notion of macroquantization could be considered as returning Bohr’s argument back to the celestial orbits. In the meantime it is not so obvious from literature why Bohr himself was so convinced with this idea of planetary quantization [12], despite such a conviction could be brought back to Titius-Bode law, which suggests that celestial orbits can be described using simple series. In fact, Titius-Bode were also not the first one who proposed this kind of simple series [13], Gregory-Bonnet started it in 1702.

In order to obtain planetary orbit prediction from this hypothesis we could begin with the Bohr-Sommerfeld’s conjecture of quantization of angular momentum. As we know, for the wavefunction to be well defined and

unique, the momenta must satisfy Bohr-Sommerfeld's quantization condition [14]:

$$\oint_{\Gamma} p \cdot dx = 2\pi \cdot n\hbar \quad (1)$$

for any closed classical orbit  $\Gamma$ . For the free particle of unit mass on the unit sphere the left-hand side is

$$\int_0^T v^2 \cdot d\tau = \omega^2 \cdot T = 2\pi \cdot \omega \quad (2)$$

where  $T=2\pi/\omega$  is the period of the orbit. Hence the quantization rule amounts to quantization of the rotation frequency (the angular momentum):  $\omega = n\hbar$ . Then we can write the force balance relation of Newton's equation of motion:

$$GMm / r^2 = mv^2 / r \quad (3)$$

Using Bohr-Sommerfeld's hypothesis of quantization of angular momentum (2), a new constant  $g$  was introduced:

$$mvr = ng / 2\pi \quad (4)$$

Just like in the elementary Bohr theory (before Schrödinger), this pair of equations yields a known simple solution for the orbit radius for any quantum number of the form:

$$r = n^2 \cdot g^2 / (4\pi^2 \cdot GM \cdot m^2) \quad (5)$$

or

$$r = n^2 \cdot GM / v_o^2 \quad (6)$$

where  $r$ ,  $n$ ,  $G$ ,  $M$ ,  $v_o$  represents orbit radii (semimajor axes), quantum number ( $n=1,2,3,\dots$ ), Newton gravitation constant, and mass of the nucleus of orbit, and specific velocity, respectively. In this equation (6), we denote

$$v_o = (2\pi / g) \cdot GMm \quad (7)$$

The value of  $m$  is an adjustable parameter (similar to  $g$ ).

Nottale [1] extends further this Bohr-Sommerfeld quantization conjecture to a gravitational-Schrödinger equation by arguing that the equation of motion for celestial bodies could be expressed in terms of a scale-relativistic Euler-Newton equation. For a Kepler potential and in the *time independent* case, this equation reads (in Ref [1c] p. 380):

$$2D^2\Delta\Psi + (E / m + GM / r) \cdot \Psi = 0 \quad (8)$$

Solving this equation, he obtained that planetary orbits are quantized according to the law:

$$a_n = GMn^2 / v_o^2 \quad (9)$$

where  $a_n, G, M, n, v_o$  each represents orbit radius for given  $n$ , Newton gravitation constant, mass of the Sun, quantum number, and specific velocity ( $v_o=144$  km/sec for Solar system and also exoplanet systems), respectively. These equations (8)-(9) form the basis of Nottale's Scale Relativity prediction of planetary orbits [1]; and equation (9) corresponds exactly with equation (6) because both were derived using the same Bohr-Sommerfeld's quantization conjecture. Another known type of observed quantization in astronomy is Tiffit's 72 km/sec quantization [13].

### 3 Macroquantum condensate, superfluid vortices

Provided the above Bohr-Sommerfeld description of macroquantization corresponds to the facts, then we could ask further what kind of physical object could cause such orbital quantization. Thereafter we could come to the macroquantum condensate argument. In this regard, astrophysical objects could be seen as results of vacuum condensation [15][16]. For instance Ilyanok & Timoshenko [17] took a further step by hypothesizing that the universe resembles a large Bose Einstein condensate, so that the distribution of all celestial bodies must also be quantized. This conjecture may originate from the fact that according to BCS theory, superconductivity can exhibit macroquantum phenomena [18]. There is also a known suggestion that the vacua consist of hypercrystalline: *classical spacetime coordinate and fields are parameters of coherent states* [19].

It is perhaps interesting to remark here that Ilyanok & Timoshenko do not invoke argument of *non-differentiability* of spacetime, as Nottale did [1]. In a macroquantum condensate context, this approach appears reasonable because Bose-Einstein condensate with Hausdorff dimension  $D_H \sim 2$  could exhibit fractality [20], implying that non-differentiability of spacetime conjecture is not required. The same fractality property has been observed in various phenomena in astrophysics [21], which in turn may also correspond to an explanation of the origin of multifractal spectrum as described by Gorski [22]. In this regard, Antoniadis *et al.* have discussed CMBR temperature (2.73° K) from the viewpoint of conformal invariance [23], which argument then could be related to Winterberg's hypothesis of superfluid Planckian phonon-roton aether [24].

Based on previous known analogy and recent research suggesting that there is neat linkage between gravitation and condensed matter physics [25][26], we could also hypothesize that planetary quantization is related to quantized vortex. In principle, this hypothesis starts with observation that in



quantum fluid systems like superfluidity, it is known that such vortexes are subject to quantization condition of integer multiples of  $2\pi$ , or  $\oint \mathbf{v}_s \cdot d\mathbf{l} = 2\pi n \hbar / m_4$ . Furthermore, such quantized vortexes are distributed in equal distance, which phenomenon is known as vorticity [4]. In large superfluid system, usually we use Landau two-fluid model, with normal and superfluid component. The normal fluid component always possesses some non-vanishing amount of viscosity and mutual friction. Similar approach with this proposed model has been considered in the context of neutron stars [27], and this quantized vortex model could also be related to Wolter's vortex [28].

#### 4 Cosmic turbulence and logarithmic type interaction

Another plausible approach to explain the origin of quantization in astronomy is using turbulence framework. Turbulence is observed in various astrophysical phenomena [21], and it is known that such turbulence could exhibit a kind of self-organization, including quantization.

Despite such known relations, explanation of how turbulence could exhibit orbital quantization is not yet clear. If *and only if* we can describe such a flow using Navier-Stokes equation [29], then we can use R.M. Kiehn's suggestion that there is exact mapping from Schrödinger equation to Navier-Stokes equation, using the notion of quantum vorticity [30]. But for fluid which cannot be described using Navier-Stokes equation, such exact mapping would not be applicable anymore. In fact, according to Kiehn the Kolmogorov theory of turbulence is based on assumption that the turbulent state consists of "vortices" of all "scales" with random intensities, but it is not based on Navier-Stokes equation explicitly, in fact "*the creation of the turbulent state must involve discontinuous solutions of Navier-Stokes equations.*" [31] However, there is article suggesting that under certain conditions, solutions of 3D Navier-Stokes equation could exhibit characteristic known as Kolmogorov length [32]. In this kind of hydrodynamics approach, macroquantization could be obtained from solution of diffusion equation [33].

In order to make this reasoning of turbulence in astrophysics more consistent with the known analogy between superfluidity and cosmology phenomena [26], we could also consider turbulence effect in quantum liquid. Therefore it seems reasonable to consider *superfluid turbulence* hypothesis, as proposed for instance by Kaivarainen [34]. There are also known relations such as discrete scale invariant turbulence [35], superstatistics for turbulence [36], and conformal turbu-

lence. Furthermore, such a turbulence hypothesis could lead to logarithmic interaction similar to Kolmogorov-type interaction across all scales [28].

Another way to put such statistical considerations into quantum mechanical framework is perhaps using Boltzmann kinetic gas approach. It is known that quantum mechanics era began during Halle conference in 1891, when Boltzmann made a remark: “*I see no reason why energy shouldn't also be regarded as divided atomically.*” Due to this reason Planck subsequently called the quantity  $2\pi\hbar$  after Boltzmann – ‘Boltzmann constant.’ Using the same logic, Mishinov *et al.* [37] have derived Newton equation from TDGL:

$$m^* d_t V_p(t) = e^* .E - m^* V_p(t) / \tau_p \quad (10)$$

This TDGL (time-dependent Ginzburg-Landau) equation is an adequate tool to represent the *low-frequency* fluctuations near  $T_c$ , and it can be considered as more universal than GPE (Gross-Pitaevskii equation).

## 5 TGD viewpoint on the origin of macroquantization in astrophysics and celestial motion

Topological geometrodynamics (TGD) viewpoint on this macroquantization subject [38] was based on recognition that this effect could be considered as simple substitution of Planck constant:

$$\hbar \rightarrow \hbar_{gr} = GMm / v_0 \quad (11)$$

provided we assert that  $\hbar = c = 1$ . The motivation is the earlier proposal inspired by TGD [39] that the Planck constant is dynamical and quantized.

As before  $v_0 = 144.7 \pm 0.7$  km/sec, giving  $v_0 / c = 4.82 \times 10^{-4}$  km/sec. This value is rather near to the peak orbital velocity of stars in galactic halos. As a sidenote, this is not the only plausible approach to make extension from geometrodynamics to Planck scale, and *vice versa* [41].

A distinction of TGD viewpoint [42] from Nottale’s fractal hydrodynamics approach is that many-sheeted spacetime suggests that astrophysical systems are not only quantum systems at larger space-time sheets but correspond to a gigantic value of gravitational Planck constant. The Bohr’s rules for the visible matter reflect the quantum dynamics of the dark matter at larger space-time sheets. Furthermore, TGD predicts the value of the parameter  $v_0$  appearing in equation (9) and explains its harmonic and subharmonics. There is also a plausible linkage between hydrodynamics approach and Kähler structure to describe the Schrödinger equation [43].

### 5.1. Consistency with TGD based model of galactic dark matter

The first step is to see whether the TGD based model for dark matter is consistent with the gravitational Schrödinger equation. The following argument was based on Bohr quantization rules [41].

- a. The gravitational potential energy  $V(r)$  for a mass distribution  $M(r)=xTr$  ( $T$  denotes string tension) is given by:

$$V(r) = Gm \int_r^{R_o} M(r).dr / r^2 = GmxT \log(r / R_o) \quad (12)$$

Here  $R_o$  corresponds to a large radius so that the potential is negative, as it should in the region where binding energy is negative.

- b. The Newton equation for circular orbit:

$$mv^2 / r = GmxT / r \quad (13)$$

which gives

$$v = xGT \quad (14)$$

- c. Bohr quantization condition for angular momentum by equation (11) reads as

$$mvr = n\hbar_{gr} \quad (15)$$

and gives:

$$r_n = n\hbar_{gr} / (mv) = n.r_1 \quad (16)$$

$$r_1 = GM / (v v_o) \quad (17)$$

where  $v$  is rather near to  $v_o$ .

- d. Bound state energies are given by

$$E_n = mv^2 / 2 - xT \log(r_1 / R_o) + xT \log(n) \quad (18)$$

The energies depend only weakly on the radius of the orbit.

- e. The centrifugal potential  $l(l+1)/r^2$  in the Schrödinger equation is negligible as compared to the potential term at large distances so that one expects that degeneracies of orbits with small values of  $l$  do not depend on the radius.

### 5.2. TGD based model of planetary system

The magnetic flux quanta (shells and flux tubes) are the carriers of the quantum coherent dark matter and behave effectively like quantum rigid bodies. This leads to a simple model for the generation of planetary system via a breaking of rotational symmetry. For inner planets this process leads from spherical shells with a full rotational symmetry to flux tubes with reduced rotational symmetry inside with planet are eventually formed. Earth

and outer planets were formed by a splitting of a flattened flux tube in the common orbital plane to 5 flux tubes corresponding to Earth and outer planets except Pluto, which indeed has orbital parameters differing dramatically from those of other planets. The replacement of  $v_o$  by its subharmonic  $v_o/5$  for these Jovian planets corresponds topologically to the splitting of a magnetic flux tube to five separate tubes.

Flux tubes and spherical cells containing quantum dark matter are predicted to be still there. The amazing finding is that the quantum time scales associated with Bohr orbits seem to correspond to important *biological* time scales. For instance, the time scale

$$T = \hbar_{gr} / E \quad (19)$$

associated with  $n=1$  orbit is precisely 24 hours. This apparently supports the prediction of TGD based theory of living matter in with quantum coherent dark matter plays a fundamental role [40].

The inclinations of planetary orbits could be a test problem for the hypothesis outlined above. The prediction is not merely statistical like the predictions given by Nottale and others [1d][1e]. The minimal value of inclination for a given principal quantum number  $n$  follows from semiclassical view about angular momentum quantization for maximal value of  $z$ -component of angular momentum  $m=j=n$  [38]:

$$\cos(\phi) = n / \sqrt{n(n+1)} \quad (20)$$

where  $\phi$  is the angle between angular momentum and quantization axis and thus also between orbital plane and  $(x,y)$ -plane. This angle defines the tilt angle between the orbital plane and  $(x,y)$ -plane. For  $n=3,4,5$  (Mercury, Earth, Venus) this equation gives  $\phi = 30.0^\circ, 26.6^\circ, 24.0^\circ$  respectively. Only the relative tilt angle can be compared with the experimental data. Taking Earth's orbital plane as reference will give 'inclination' angle, i.e. 6 degrees for Mercury, and 2.6 degrees for Venus. The observed values are 7.0 and 3.4 degrees, respectively, which are in good agreement with prediction.

Bohr-Sommerfeld rules allow also estimating eccentricities and the prediction is [38]:

$$e^2 = 2 \cdot (\sqrt{1 - m^2/n^2}) / (1 + \sqrt{1 - m^2/n^2}) \quad (21)$$

The eccentricities are predicted to be very large for  $m < n$  unless  $n$  is very large and the only possible interpretation is that planets correspond in the lowest order approximation to  $m=n$  and  $e=0$  whereas comets with large eccentricities could correspond to  $m < n$  orbits. In particular, for  $m < n$  comets in Oort Clouds

( $n < 700$ ) the prediction is  $e > 0.32$ . This could be a good test problem for further astronomical observation.

### Concluding remarks

In this article, some plausible approaches to describe the origin of macro-quantization in astrophysics and also celestial motion are discussed. While all of these arguments are interesting, it seems that further research is required to verify which arguments are the most plausible, corresponding to the observed astrophysics data.

After all, the present article is not intended to rule out the existing methods in the literature to predict quantization of celestial motion, but instead to argue that perhaps this macroquantization effect in various astronomy phenomena requires a new kind of theory to describe its origin.

### Acknowledgement

Special thanks go to Prof. M. Pitkänen for insightful discussions in particular on his TGD theory, and also for reading the draft version and suggesting improvement. The writer also expresses his sincere thanks to Profs. C. Castro, R.M. Kiehn, A. Rubčić, and E. Scholz for discussions and various suggestions during development of ideas presented herein. Kindful translation of the abstract by Prof. Ezzat G. Bakhom is gratefully appreciated.

### References

- [1] Nottale, L., G. Schumacher, & E.T. Levefre, *Astron. Astrophys.* **361**, 379-387 (2000); [1b] Nottale, L., "Non-differentiable space-time and scale relativity," in *Proc. Inter. Colloquium Géométrie au XXè siècle*, Paris, 24-29 Sept. 2001, Ed. D. Flament; [1c] Nottale, L., *Astron. Astrophys.* **327**, 867-889 (1997); [1d] Nottale, L., *Chaos, Solitons and Fractals* **7**, 877-938 (1996) in particular equation (156); [1e] Galopeau, P.H.M., *et al.*, *Geophysical Research Abstract* **5**, 11864 (2003); [1f] Da Rocha, D., & L. Nottale, arXiv:astro-ph/0310036, astro-ph/0310031, preprint at <http://www.daec.obspm.fr/users/nottale>
- [2] Rubčić, A., & J. Rubčić, "The quantization of solar-like gravitational systems," *Fizika B* **7** Vol. 1, 1-13 (1998).
- [3] Agnese, A.G., & R. Festa, *Proc. Workshop on Modern Modified Theories of Gravitation and Cosmology* 1997, preprint at arXiv:astro-ph/9807186 (1998). Also Agnese, A.G., astro-ph/9910534; Neto, M., *et al.*, arXiv:astro-ph/0205379.

- [4] Chechel'nitsky, A., "Hot points of the Wave Universe concept," in JINR, Dubna, Aug. 22-26, 2000; preprint at arXiv:physics/0102036 (2001); [4b] Chechel'nitsky, A., "Epoch of quantization and Wave Universe," (1995) <http://web.ccr.jussieu.fr>.
- [5] Coles, P., arXiv:astro-ph/0209576 (2002); [5b] Chavanis, P., arXiv:astro-ph/9912087 (1999).
- [6] Armitage, P.J., *et al.*, Mon.Not.R. Astron. Society, (2002); preprint at arXiv:astro-ph/0204001.
- [7] Lineweaver, C. *et al.*, Scientific Frontiers in Research on Extrasolar Planets, *ASP Conf. Series* Vol. **28**, Deming *et al.* (eds), (2003) preprint at arXiv:astro-ph/0209382.
- [8] Oudet, X., "The quantum state and the doublets," *Annales de la Fondation Louis de Broglie* Vol. **25** No.1, 24p (2000).
- [9] Sakharov, A.S., & H. Hofer, "Development of the universe and new cosmology," CERN-TH/2003-101, arXiv:astro-ph/0309026 (2003).
- [10] Grigorescu, M., "Physical framework of quantization problem," arXiv:physics/0306079 (2003).
- [11] Daboul, J., & M.M. Nieto, "Exact  $E=0$  solutions for general power law potentials. I. Classical orbits," arXiv:hep-th/9408057 (1994).
- [12] Kleppner, D., & R. Jackiw, *Science* Vol. **289**, No. 5481, Issue of 11 (Aug 2000), pp. 893-898.
- [13] Trimble, V., "Astrophysics faces the Millennium part III: The ratios of small whole numbers. Misadventures in astronomical quantization," (2000).
- [14] Van Holten, J., arXiv:gr-qc/0107041 (2001).
- [15] Chapline, G., arXiv:hep-th/9812129 (1998).
- [16] Chapline, G., *et al.*, arXiv:gr-qc/0012904 (2001), gr-qc/0407033.
- [17] Ilyanok, A., & I.A. Timoshenko, "Quantization of masses in the solar system," arXiv: astro-ph/0201057(2002). Also astro-ph/9912537 (1999), astro-ph/0111182, astro-ph/0111183.
- [18] Schrieffer, J.R., "Macroscopic quantum phenomena from pairing in superconductors," Lecture, December 11<sup>th</sup> (1972).
- [19] Finkelstein, D.R., *et al.*, "Hypercrystalline vacua," arXiv:quant-ph/9608024 (1996).
- [20] Kolomeisky, E.B., *et al.*, arXiv:cond-mat/0002282 (2000).
- [21] Combes, F., arXiv:astro-ph/9906477 (1999). Also Chappell, D., & J. Scallo, astro-ph/9707102; Baryshev, Y.V., astro-ph/9912074.
- [22] Gorski, A.Z., arXiv:chao-dyn/9804034 (1998).

- [23] Antoniadis, I., P. Mazur, & E. Mottola, "Conformal invariance and Cosmic Background Radiation," *Phys.Rev.Lett.* **79** (1997) 14-17; preprint at arXiv:astro-ph/9611208. Also E. Scholz, arXiv:astro-ph/0403446.
- [24] Winterberg, F., "Planck mass rotons as cold dark matter and quintessence," presented at the 9<sup>th</sup> Canadian Conf. on General Relativity and Relativistic Astrophysics, Edmonton, May 24-26<sup>th</sup> (2001); also in *Z. Naturforschung* **57a** (2002) 202-204.
- [25] Zurek, W., "Cosmological experiments in superfluids and superconductors," in *Proc. Euroconference Formation and Interaction of Topological Defects*, A. Davis & R. Brandenberger (eds.) Plenum (1995); preprint at arXiv:cond-mat/9502119. [25b] Barcelo, C., *et al.*, "Analogue gravity from Bose-Einstein condensate," *Class. Quantum Grav.* **18**, 1137-1156 (2001). [25c] D.L. Kovrizhin & L.A. Maksimov, arXiv:cond-mat/0109236.
- [26] Volovik, G., "Superfluid analogies of cosmological phenomena," arXiv:gr-qc/0005091 (2000); [26b] Volovik, G., "Links between gravity and dynamics of quantum liquids," in *Proc. Inter. Conf. "Cosmology, Relativistic Astrophysics, Cosmoparticle Physics" (COSMION-99)*, preprint at arXiv:gr-qc/0004049; [26c] Volovik, G., arXiv:gr-qc/0104046; [26d] Nozieres, P., & D. Pines, *The theory of quantum liquids: Superfluid Bose Liquid*. Wesley Publ. Co. Inc., 116-124 (1990).
- [27] Sedrakian, A., *et al.*, arXiv:astro-ph/9801188 (1998).
- [28] Rosu, H., arXiv:quant-ph/9506015 (1995).
- [29] Gibson, C., "Turbulent mixing, diffusion and gravity in the formation of cosmological structures," *Proc. FEDSM99*, July 18-23, 1999, San Francisco (1999). Also Gibson, C., & R. Schild, preprint for *The Astronomical Journal*, arXiv:astro-ph/0304483 (2003).
- [30] Kiehn, R.M., "An interpretation of wave-function as a measure of vorticity," <http://www22.pair.com/csdc/pdf/cologne.pdf> (1989).
- [31] Kiehn, R.M., "Topology and turbulence," arXiv:physics/0102003 (2001).
- [32] Grassi, V., *et al.*, arXiv:math-ph/9912008 (1999).
- [33] Castro, C., J. Mahecha, & B. Rodriguez, arXiv:quant-ph/0202026v1 (2002).
- [34] Kaivarainen, A., "Hierarchic models of turbulence, superfluidity and superconductivity," arXiv:physics/0003108 (2000). Also in <http://www.karelia.ru/~alexk>
- [35] Sornette, D., "Discrete scale invariance in turbulence?" *Proc. 7<sup>th</sup> European Turbulence Conf. (ETC-7)*, June 1998, Kluwer, U. Frisch (ed.), preprint at arXiv:cond-mat/9802121 (1998).
- [36] Beck, C., arXiv:physics/0303061(2003).
- [37] Mishonov, T.M., *et al.*, "Kinetics and Boltzmann kinetic equation for fluctuation Cooper pairs," arXiv:cond-mat/0302046 (2003).

- [38] Pitkänen, M., <http://www.physics.helsinki.fi/~matpitka/articles/nottale.pdf>
- [39] Pitkänen, M., "Equivalence of Loop Diagrams with Tree Diagrams and Cancellation of Infinities in Quantum TGD" of "Topological Geometro-dynamics", [www.physics.helsinki.fi/~matpitka/tgd.html#bialgebra](http://www.physics.helsinki.fi/~matpitka/tgd.html#bialgebra)
- [40] Pitkänen, M., "Time, Space-Time, and Consciousness", <http://www.physics.helsinki.fi/~matpitka/cbookII.html#time>
- [41] Spaans, M., arXiv:gr-qc/9612027 (1996). Also M. Blasone, P. Jizba, G. Vitiello, arXiv:math-ph/0402034 (2004).
- [42] Pitkänen, M., "Topological Geometro-dynamics I, II," Chaos, Solitons, Fractals **13**, no. 6 (2002) 1205, 1217.
- [43] Reginatto, M., arXiv:quant-ph/9909065 (1999).

*First version: Oct 8<sup>th</sup> 2004, 1<sup>st</sup> revision: Oct 13<sup>th</sup> 2004, 2<sup>nd</sup> revision: Jan 18<sup>th</sup> 2005.*



# The Cantorian Superfluid Vortex Hypothesis

V. Christianto, vxianto@yahoo.com

Reprinted with kind permission from Apeiron editor

The present article suggests a preliminary version of Cantorian superfluid vortex hypothesis as a plausible model of non-linear cosmology. Using the proposed model we explain the physical origin of quantum-like approach to describe planetary orbits as proposed in the recent literature. The meaning of the Cantorian superfluid vortex hypothesis is discussed, particularly in the context of offering a plausible mechanism of gravitation-related phenomena from boson condensation. Some advantages and unsolved questions are discussed.

*Keywords:* superfluid aether, Bose-Einstein condensate, phion, multiple vortices, gravitational instability.

## Introduction

In recent years, there has been a growing interest in the quantum approach to describing orbits of celestial bodies. While this approach has not been widely accepted, the motivating idea of this approach was Bohr-Sommerfeld's hypothesis of quantization of angular momentum, and therefore it shows some resemblance to the Schrödinger wave equation (Chavanis 1999, Nottale 1996, Neto *et al.* 2002). The application of wave mechanics to large-scale structures (Coles 2002) has led to impressive results in terms of prediction of

planetary semimajor axes, especially orbits of exoplanets (Nottale *et al.* 1997, 2000). However, a question arises as to how to describe the physical origin of wave mechanics of such large-scale structures. This leads to the Volovik-Winterberg hypothesis of the superfluid phonon-roton as a quantum vacuum aether (Volovik 2001, Winterberg 2002a, 2002b).

To extend the superfluid aether hypothesis further in order to explain nonlinear phenomena in cosmology, we propose a new Cantorian Superfluid Vortex (CSV) hypothesis. The present article discusses some questions related to this hypothesis, including:

- a. What is the meaning of Cantorian Superfluid Vortex?
- b. Why do we require this model?
- c. How can we represent various high-temperature phenomena in cosmology using low-temperature superfluid physics?
- d. What are its advantages and implications compared to present theories?
- e. What are the unsolved questions and possible future research?

We begin with question b, in particular with reference to reconciling Quantum Mechanics and GTR. Further discussion of the proposed hypothesis will be reserved for a forthcoming article.

## **QM, GTR, QED, Sachs**

For almost eight decades theoretical physicists have toiled to reconcile Quantum Mechanics and Einstein's (General) Theory of Relativity, beginning with Dirac, and continuing with leading scientists up to this time. As a result, several different approaches are taken by theoretical physicists today, including such theories as:

- QED & QFT: these can be considered as two of the best experimentally confirmed theories up to this day. For an

introduction, see for example Weinberg (1993, 1997) and Siegel (1999).

- Sachs's theory: in principle Sachs has attempted to bring the four-dimensional geometrical world into QM.<sup>1</sup>
- Other refinements of GTR such as Weyl's (conformal gravity) solution, *etc.*
- Various versions of string theories: supergravity, superstring, supersymmetry, brane universe, *etc.*
- One lesser known approach is the diametrical opposite of Sachs's approach: it claims that quantum (wave) mechanics theory is sufficient to explain the phenomena corresponding to GTR (Coles 2002).

A major obstacle here is how to reconcile the four-dimensional geometrisation of GTR with common three-dimensional QM. As is well known, GTR was constructed as a geometrification of physical reality: GTR's attempt to describe gravity is purely geometric and macroscopic. As such, there are some known limitations in GTR,<sup>2</sup> including:

- a. Classical general relativity by itself is unable to predict the sign of the gravitational force (attraction rather than repulsion). Consoli (2000) also noted: "*Einstein had to start from the peculiar properties of Newtonian gravity to get the basic idea of transforming the classical effects of this type of interaction into a metric structure.*" In other words, it seems that GTR is not the *complete* theory Einstein was looking for.
- b. There is no mechanism for gravitational forces: the 'graviton' has never been observed.

- c. There is no convincing mechanism to describe the interaction between matter, inertia, and space (Mach principle is merely postulated).
- d. There is no description of the medium of space. Although Einstein apparently considered a perfect fluid to describe this medium in his Leiden lecture in 1921 (Einstein 1921), he never attempted to theorize this medium formally—perhaps for good reason.<sup>3</sup>
- e. It is quite difficult to imagine how matter can affect the spacetime curvature and *vice versa* as postulated by GTR (for instance H. Arp).
- f. Using GTR it is also quite difficult to explain the so-called ‘hidden matter’ which is supposed to exist in order to get average density of matter in the universe that required for flat universe,  $\Omega=1$  (Chapline 1998). Alternatively some theorists have shown we can reconcile this issue using Navier-Stokes model (Gibson 1999).
- g. The spacetime curvature hypothesis cannot explain phenomena in the micro world of Quantum Mechanics. In contrast, by the Ehrenfest theorem, Quantum Mechanics reduces to classical physics if we use classical parameters consistently (see also Signell 2002).

However, we should recognize that the strong point of GTR is to generalize the Maxwell equations to the gravity field and to introduce the equivalence principle, as observed by recent experiments. Therefore according to Consoli (2000): “all classical experimental tests of general relativity would be fulfilled in any theory incorporating the Equivalence Principle.” We should also note that Einstein was quite right in pointing out the incompleteness of QM (as

described by the Copenhagen school). Therefore, we would expect to find a reformulation of QM, which is capable of describing known phenomena in support of GTR, such as the bending of light rays, clock delay due to the gravitational field and also the precession of the perihelion of planet Mercury. Attempts to generalise (QM) wave mechanics to describe the motion and distribution of celestial objects have been made, for instance by Coles (2002), Neto *et al.* (2002), Nottale *et al.* (1997, 2000) and Zakir (1999).

Therefore, we may conclude the following: to reconcile GTR (phenomena) and QM, we have to begin by finding the mechanism of gravitation and its interaction with the medium of space. This leads us to the scalar field hypothesis as discussed below.

## **Whittaker, scalar field, phion condensate**

The scalar field hypothesis as a description of gravitation is not a recent idea at all. Whittaker, a leading physicist and mathematician in his time, originated the idea of a (longitudinal) scalar field while studying the nature of partial differential equations.<sup>4</sup> To quote Whittaker:

*...the gravitational force in each constituent field will be perpendicular to the wave-front: the waves will be longitudinal... this undulatory theory of gravity would require gravity should be propagated with a finite velocity, which however need not be the same as of light, and may be enormously greater.*

Whittaker's student, Dirac, upon reading Whittaker's idea, then came up with his idea of the 'electron sea', though this was later found to be at odds with observation. Therefore the scalar field must be closely linked to the medium of space (aether, or its modern

version ‘*quantum vacuum fluctuation*’; see Chapline 1998, Rothwarf 1998). In Whittaker’s formulation, one of the features of this scalar field is that its speed is much higher than the speed of light  $c$ . This hypothesis is recently supported by Van Flandern’s theory on the ‘speed of gravity’.<sup>5</sup>

Now if we accept that a scalar field can describe the mechanism of gravitation, the question then arises: *what is the physical nature of this scalar field*. Some physicists have argued that gravitation is actually a long-wavelength excitation of a scalar condensate inducing spontaneous symmetry breaking (Consoli 2000, 2002). This scalar field is represented by the ‘phion condensate’. In this sense, the Mach principle represents an inextricable linkage between inertia and gravity due to the common origin of the phenomena: condensation of the scalar field.<sup>6</sup>

We now come to the core hypothesis of CSV theory: *the ‘phion condensate’ can be modeled by zero temperature superfluid physics* (Consoli 2000). Therefore, we treat the ‘superfluid’ as the quantum vacuum aether medium (as proposed by Winterberg 2002a, 2002b). In this way, we are no longer considering superfluidity merely as a useful analogy to describe various phenomena of cosmology (Volovik 2000b, 2001), but instead as a *real* fluid medium in accordance with Gibson’s model (Gibson 1999).<sup>7</sup> In this regard, it becomes very convenient to consider the Navier-Stokes equations (Zalaletdinov 2002). Furthermore to represent a real superfluid model in cosmology, we propose a new term: ‘superfluid cosmology.’ This conjecture implies that there should be various nonlinear phenomena in cosmology which are thus far inexplicable using the ‘geometrification’ approach, including the ‘hidden matter’ problem. In other words, if we use a real fluid model for nonlinear cosmology, we do not have to invoke some kind of exotic matter to explain the nature of ‘hidden matter’.

Now, with regard to GTR experiments, we also consider Consoli's (2000) idea that "all classical experimental tests of general relativity would be fulfilled in any theory incorporating the Equivalence Principle." Therefore, because the CSV hypothesis was in principle also based on the same phion condensate mechanism, we can predict the same effects as were predicted by Consoli (2000).

Furthermore, the real Cantorian superfluid model also implies that it is possible to conduct a set of laboratory experiments to replicate real cosmological objects (Volovik 2001, Zurek 1995), provided we take into consideration proper scale modeling (similitude) theories.

## **What is the Cantorian superfluid vortex?**

Once we agree with the above proposition on the role of phion condensate in describing the gravitational interaction, we are now ready to consider the meaning of the Cantorian Superfluid Vortex (CSV) hypothesis. Term 'Cantorian'<sup>8</sup> here represents the *transfinite set* introduced by Georg Cantor. As we know, the transfinite set introduces the mapping of a set onto itself, better known as a 'self-similar' pattern. This pattern is observed in various natural phenomena, including vortex phenomena. The notion of Cantorian vortices can be defined in simple terms as the tendency of multiple vortices to be present in a real fluid medium, including superfluidity. (See Nozieres & Pines 1990, Quist 2002, Volovik 2000a, 2000b, 2000c.)<sup>9</sup> Therefore, with regards to superfluid cosmology, in principle the Cantorian Superfluid Vortex hypothesis suggests that there is a tendency in nature as follows:

**Lemma I: "There are mini vortices within bigger vortices *ad infinitum*."**

A flow pattern where the streamlines are concentric circles is known as a circular vortex. If the fluid particles rotate around the

vortex centre, the vortex is called rotational. It also follows that the vortex moves with the fluid. It is also known that real fluid flow is never irrotational, though the mean pattern of turbulent flow outside the boundary layer resembles the pattern of irrotational flow. In rotational flow of real fluids, vorticity can develop as an effect of viscosity. The term ‘vorticity’ is defined as the number of circulations in a certain area, and it equals the circulation around an elemental surface divided by the area of the surface (assuming the vortex lattice exists). Since the vortex moves with the fluid, the vortex tube retains the same fluid elements, and these elements retain their vorticity. And provided other factors remain the same, vortices can neither be created nor destroyed in a non-viscous fluid.

In quantum fluid systems like superfluidity, it is known that such vortices are subject to a quantization condition of integer multiples of  $2\pi$ , or  $\oint v_s \cdot dl = 2\mathbf{p} \cdot n\mathbf{h} / m_4 = n\mathbf{k}_o$ . Such quantized vortices are distributed at equal distance from one another, which is known as vorticity. Furthermore, in large superfluid systems usually we use Landau two-fluid model, with normal and superfluid components. The normal fluid component always possesses some nonvanishing amount of viscosity and mutual friction.

This vortex formation phenomenon is well known in various turbulence-related fluid phenomena such as tornadoes and tropical hurricanes; and it can be represented by the Navier-Stokes equation (Zalaletdinov 2002). Therefore, mathematically we treat the ‘vortex’ as a stable solution (Kivshar *et al.* 1999) and a consequence of Navier-Stokes equation. Furthermore it is known there is *exact mapping* between the Schrödinger equation and Navier-Stokes equation (Kiehn 1989, 1999), therefore the Cantorian Superfluid Vortex hypothesis requires a second conjecture:



**Lemma II: “Vortices are considered stable solutions of the Navier-Stokes equations.”**

Since we know the Navier-Stokes equation leads us to nonlinear fluid phenomena in cosmology (Gibson 1999) and also superfluid vortices (Godfrey *et al.* 2001, Prix 2000), then the Cantorian Superfluid Vortex hypothesis also proposes:

**Lemma III: “Cantorian Superfluid Vortex theory is capable to represent various phenomena of nonlinear cosmology.”**

Nottale’s Scale Relativity Theory (Nottale 1996, 1997, 2001, 2002) leads us to some interesting implications including:

- I. The Euler-Newton equation can be generalized to represent various phenomena in cosmology across different scales. Because the Euler-Newton equation can be considered a subset (in the inviscid limit) of the Navier-Stokes equation, then the Navier-Stokes equation can also be considered applicable to any scale (scale covariant).
- II. Because Scale Relativity Theory can be used to derive the Dirac equation (Celerier & Nottale 2002), we also conclude that Scale Relativity Theory implies there is an ‘electron sea’ medium, in Dirac’s words, to represent interactions across different scales.

Hence we may also conclude that:

**Lemma IV: “The Cantorian Superfluid Vortex is a plausible medium to describe the motion of various celestial objects governed by the Navier-Stokes equation, and to represent a medium for interactions across various scales.”**

In other words, and considering the *exact correspondence* between the Schrödinger equation and the Navier-Stokes equation, the Cantorian Superfluid Vortex hypothesis also suggests:<sup>10</sup>

**Lemma V: “Schrödinger equation can be treated as a real diffusion theory, capable of describing various celestial phenomena at various scales.”**

In this sense, despite some similarities in their consequences and cosmological implications, the Cantorian Superfluid Vortex model is quite different from Nottale’s Scale Relativity Theory, since it relies on a real fluid model right from the beginning.<sup>11</sup> Using this model, we can expect to get a proper mechanism and medium for gravity interactions, which GTR is lacking.

A question arises here concerning whether the proposed Cantorian Superfluid Vortex hypothesis is really *different* from Nottale’s Scale Relativity Theory. Therefore it is perhaps worth mentioning here Nottale’s own opinion (Nottale 1996):

*We stress once again the fact, diffusion here is only an interpretation. Our theory is not statistical in its essence, contrarily to quantum mechanics or to diffusion approaches. In scale relativity, the fractal space-time can be completely ‘determined’, while the undeterminism of trajectories is not set as a founding stone of the theory, but as a consequence of the nondifferentiability of space-time. In our theory, ‘God does not play dice’, ...*

*In summary, our point of view is quantum objects are neither ‘waves’ nor ‘particles’, ... while our experiments, being incomplete, put into evidence only the module. There is no ‘complementarity’ here, since the phase is never directly seen, .... There is therefore no mystery when one can jump instantaneously from observing the ‘wave’ behavior to observing the ‘particle’ behavior without physically disturbing the system, but only by changing the observing way. Both properties were present before the observation, even if only one of them was seen.*

In other words, we argue here that Nottale’s Scale Relativity Theory is insightful in its representation of a scale covariant theory of gravitation, but it is lacking an explanation of the medium of the gravitation interaction mostly due to the evagueness of the distinction between the real diffusion theory and the statistical interpretation of QM (in particular, Schrödinger equation).<sup>12</sup>

Furthermore, this could have been anticipated, because Nottale’s Scale Relativity Theory tends to neglect the significance of real medium modeling: it has some inherent limitations in predicting nonlinear phenomena in cosmology (Gibson 1999).

In this regard, the Cantorian Superfluid Vortex hypothesis can be considered an extended version of Nottale’s scale relativity theory toward a real fluid model of nonlinear cosmology. In other words, the proposed Cantorian Superfluid Vortex theory considers Scale Relativity Theory merely a transformation theory, such as STR or the Ehrenfest theorem: its contribution is to show the generality and applicability of the Schrödinger equation for predicting phenomena at cosmological scales. However, in the present author’s opinion, Nottale’s Scale Relativity Theory lacks a convincing description of

why and what kind of medium and mechanism can represent these phenomena.

## **What are its advantages over the present theories**

From the Cantorian Superfluid Vortex hypothesis we can expect certain advantages over existing theories, including:

- a. Describes the origin of outer planet distribution in a (planar) solar system, without invoking an *ad hoc* second quantum number as Nottale (1996) or Neto *et al.* (2002) did;
- b. Predicts the existence of a vortex center in galaxies (similar to the ‘eye’ in hurricane and tornadoes);
- c. Predicts new planets in the outer orbits beyond Pluto;
- d. Explains the same phenomena as predicted by GTR (precession of perihelion of Planet Mercury, *etc.*) similar to what has been suggested by Consoli (2000);
- e. Describes the physical nature of the quantum vacuum aether medium and also the mechanism of the gravitation interaction (Chapline 1998, Consoli 2000, 2002);
- f. Simplicity preserved by retaining the notion of three dimensional space and one dimension time; thus QM can be generalized to cosmological scales naturally (Coles 2002, Neto *et al.* 2002, Signell 2002, Zakir 1999, Zurek 1995);
- g. Explains why the universe is observed as flat Euclidean, not as curved spacetime as predicted by Einstein (flat spacetime has also been considered for instance by K. Akama and P.V. Moniz).<sup>13</sup> This is because *there is no such thing as curved spacetime*, at least not in the proposed Cantorian Superfluid Vortex theory (see also Chapline 1998, Winterberg 2002a, 2002b);

- h. Solves some known paradoxes in QM.

## Unsolved questions and possible future research

Despite the above advantages, there are unsolved questions that require further research, including:

- Explain other nonlinear cosmological phenomena from superfluidity viewpoint, including nebulae, pulsars, neutron stars, gamma ray bursts, *etc.* (DeAquino 2002, 2002a, Gibson 1999, Sedrakian & Cordes 1997);
- Reconcile the proposed Cantorian Superfluid Vortex theory with various phenomena at quantum scale, as predicted by QED, *etc.* (Nottale 1996, 1997, 2001, 2002a, 2002b);
- Provide a mathematical explanation of various known QM paradoxes;
- Explain known electromagnetic theories of Maxwell, *etc.*;
- Provide a measurable prediction of the smallest entity in nature. The proposed Cantorian Superfluid Vortex theory prefers ‘vorton’ instead of ‘photon’ as the smallest entity in nature.

Other phenomena may have been overlooked here. The above list is merely an introductory ‘*to-do list*’.

In the present article we have discussed some reasons for considering Cantorian superfluid vortices as the basis of cosmology modeling. While of course this approach has not been widely accepted yet, in the author’s opinion it could reconcile some known paradoxes both in quantum mechanics (*e.g.*, duality of wave-particle), and also in cosmology (clustering, inhomogeneity, hidden matter). Further discussion of the proposed hypothesis will be reserved for a forthcoming article where some implications and open questions will

be discussed. Furthermore, in the near future we expect that there will be other theories based on a real fluid model, which are capable of predicting various cosmological phenomena in a more precise way.

## References

1. Barcelo, C., S. Liberati, & M. Visser, "Analogue gravity from field theory normal modes," *Class. Quantum Grav.* 18 (2000) 3595-3610.
2. Barge, P., & J. Sommeria, "Did planet formation begin inside persistent gaseous vortices?" published in *arXiv:astro-ph/9501050*. Also in *Astronomy & Astrophysics* 19.8.2002 (1995),
3. Castro, C., A. Granik, & M. El Naschie, "Scale relativity in Cantorian space," *arXiv:hep-th/0004152* (2000).
4. Castro, C. & A. Granik, "Scale relativity in Cantorian space and average dimensions of our world," *Chaos, Solitons & Fractals*, Vol. 12 No. 10 (2001) 1793-1816; also *arXiv:hep-th/0004152*.
5. Celerier, M.N. & L. Nottale, "A scale-relativistic derivation of the Dirac Equation," *Electromagnetic Phenomena*, in press, special issue dedicated to the 75<sup>th</sup> anniversary of the discovery of the Dirac equation (Oct 2002). Published at <http://www.daec.obspm.fr/users/nottale>. Also in *arXiv:hep-th/0210027*.
6. Chapline, G., "The vacuum energy in a condensate model of spacetime," *arXiv:hep-th/9812129* (1998).
7. Chavanis, P., "Trapping of dust by coherent vortices in the solar nebula," *arXiv:astro-ph/9912087* (1999).
8. Christianto, V., "Scale effect in quantization of semimajor axes of solar-like systems" (Dec 2002) available at <http://reachme.at/coolbit>.
9. Coles, P., "The wave mechanics of large-scale structure," *arXiv:astro-ph/0209576* (2002).
10. Consoli, M., "Gravitational forces from Bose-Einstein condensate," *arXiv:hep-ph/0002098* (2000).
11. Consoli, M., "A connection between gravity and the Higgs field," *arXiv:hep-ph/0204106* (2002).
12. De Aquino, F., "The gravitational mass at the superconducting state," *arXiv:physics/0201508* (2002).

13. De Aquino, "Some cosmological consequences of the correlation between the gravitational and inertial mass," *arXiv:physics/0205040* (2002a).
14. Dereli, T., & R. Tucker, "On the detection of scalar field induced spacetime torsion," *arXiv:gr-qc/0104050* (2001).
15. Einstein, A., *Relativity: The Special and the General Theory*. Random House, London (1952).
16. Einstein, A., *Sidelights on Relativity*. Methuen and Co., London (1921).
17. Gibson, C., "Turbulent mixing, diffusion and gravity in the formation of cosmological structures," *Proceedings of FEDSM99*, July 18-23, 1999, San Francisco (1999).
18. Godfrey, S.P. *et al.*, "A new interpretation of oscillating flow experiments in superfluid Helium II," *J. Low Temp. Physics*, Vol. 125, Nos. 112 (Oct 2001).
19. Kiehn, R.M., "An interpretation of wave-function as a cohomological measure of quantum vorticity," Florida, <http://www22.pair.com/csd/pdf/cologne.pdf> (1989).
20. Kiehn, R.M., "An extension of quantum theory to include Non-gradient Potentials and the production of vortices," <http://www22.pair.com/csd/pdf/bohmpplus.pdf> (1999).
21. Kivshar, Y., *et al.*, "Dynamics of optical vortex solitons," *Optics Communications* 152, Elsevier (1998) 198-206.
22. Munera, H., "Michelson-Morley experiments revisited: systematic errors, consistency among different experiments, and compatibility with absolute space," *Apeiron* Vol. 5 No. 1-2, Jan-Apr (1998).
23. Neto, M., *et al.*, "An alternative approach to describe planetary systems through a Schrodinger-type diffusion equation," *arXiv:astro-ph/0205379* (Oct 2002).
24. Nottale, L., "Scale Relativity and Fractal Space-Time: Application to Quantum Physics, Cosmology and Chaotic systems," *Chaos, Solitons and Fractals*, 7, (1996) 877-938. Also published at <http://www.daec.obspm.fr/users/nottale>. See particularly p. 50-53.
25. Nottale, L. *et al.*, "Scale relativity and quantization of the Solar System," *Astron. Astrophys.* 322, (1997) 1018. Also published at <http://www.daec.obspm.fr/users/nottale>.

26. Nottale, L., "Scale relativity and quantization of the universe I: Theoretical framework," *Astron. Astrophys.* 327, (1997) 867-889. Also published at <http://www.daec.obspm.fr/users/nottale>.
27. Nottale, L., Schumacher, G., & E.T. Levefre, "Scale-relativity and quantization of exoplanet orbital semi-major axes," *Astron. Astrophys.* 361, (2000) 379-387. Also published at <http://www.daec.obspm.fr/users/nottale>.
28. Nottale, L., "Non-differentiable space-time and scale relativity," in "Géométrie au XXè siècle", *Proc. of International Colloquium*, Paris, 24-29 Septembre 2001, Ed. D. Flament, in press (2002a) As published at <http://www.daec.obspm.fr/users/nottale>.
29. Nottale, L., "Scale relativistic cosmology," *Chaos, Solitons and Fractals* (2002b) As published at <http://daec.obspm.fr/users/nottale>.
30. Nozieres, P., & D. Pines, *The theory of quantum liquids: Superfluid Bose Liquid*. Wesley Publ. Co. Inc., (1990) p. 116-124.
31. Prix, R., "Covariant vortex in superconducting-superfluid-normal fluid mixtures with stiff equation of state," *arXiv:gr-qc/0004076* (2000).
32. Quist, M., "Vortex dynamics in the nonlinear Schrödinger equations," *arXiv:cond-mat/0211424* (Nov. 2002).
33. Roberts, M., "Vacuum energy," *arXiv:hep-th/0012062* (2001).
34. Rosu, H.C., "Pedestrian notes on quantum mechanics," *arXiv:gr-qc/9411035* (1994).
35. Rothwarf, A., "An aether model of the universe," *Phys. Essay* 11 (1998) 444-466.
36. Sedrakian, A. & J. Cordes, "Generation of pulsar glitches: superfluid core model," *Proc. 18<sup>th</sup> Texas Symposium on Relativistic Astrophysics*, eds. A. Olinto, J. Frieman & D. Schram, World Scientific Press, (1997), *arXiv:astro-ph/9709277*.
37. Siegel, W., "Fields," C.N. Yang Institute for Theoretical Physics. *arXiv:hep-th/9912205* (Sep 2002).
38. Signell, P., "Newton's second law from quantum physics," *Project PHYSNET*, <http://www.physnet.org/home/modules/license.html> (2002) 8p.
39. Volovik, G., "Links between gravity and dynamics of quantum liquids," *Int. Conf. "Cosmology. Relativistic Astrophysics. Cosmoparticle Physics" (COSMION-99)* (2000a). As published at *arXiv:gr-qc/0004049*.



40. Volovik, G., "Superfluid analogies of cosmological phenomena," *arXiv:gr-qc/0005091* (2000b).
41. Volovik, G., "Vortices observed and to be observed," *arXiv:cond-mat/0005431* (2000c).
42. Volovik, G., "Vacuum in quantum liquids and in general relativity," *arXiv:gr-qc/0104046* (2001).
43. Weinberg, S., *Dreams of final theory*, Vintage, London. (1993) 180-182, 214-215.
44. Weinberg, S., "What is quantum field theory and what did we think it is?" *arXiv:hep-th/9702027* (Feb 1997).
45. Winterberg, F., "Maxwell's Aether, the Planck Aether hypothesis, and Sommerfeld's Fine Structure Constant." [http://www.cet.sunderland.ac.uk/webedit/allweb/news/Philosophy\\_of\\_Science/Maxwell's%20Aether,%20the%20Planck%20Aether%20Hypothesis%20and%20Sommerfeld's%20Finestructure%20Constant.doc](http://www.cet.sunderland.ac.uk/webedit/allweb/news/Philosophy_of_Science/Maxwell's%20Aether,%20the%20Planck%20Aether%20Hypothesis%20and%20Sommerfeld's%20Finestructure%20Constant.doc) (2002a) see also <http://www.znaturforsch.com/56a/56a0681.pdf> .
46. Winterberg, F., "Planck mass rotons as cold dark matter and quintessence," presented at the 9<sup>th</sup> *Canadian Conf. on General Relativity and Relativistic Astrophysics*, Edmonton, May 24-26 2001; also in *Z. Naturforsch 57a*, 202-204 (2002b).
47. Zakir, Z., "Gravitation as quantum diffusion," *arXiv:gr-qc/9906079* (1999).
48. Zalaletdinov, R., "Averaging out inhomogenous Newtonian cosmologies: Newtonian Cosmology and the Navier-Stokes-Poisson Equations," *arXiv:gr-qc/0212071* (Dec 2002).
49. Zurek, W.H., "Cosmological experiments in superfluids and superconductors," in *Proc. Euroconference Formation and Interaction of Topological Defects*, A.C. Davis & R.N. Brandenberger (eds.) Plenum (1995). Also in Los Alamos preprint LAUR 95-170, *arXiv: cond-mat/9502119*.

---

## Notes

<sup>1</sup> See the articles by Mendel Sachs at <http://www.compukol.com/mendel>, also *Annales Foundation Louis de Broglie* vol. 27, 85 (2002). Also Chapter 11 in

---

*Modern Nonlinear Optics* Part I. Advances in Chemical Physics, Volume 119, Series editors: I. Prigogine *et al.*, John Wiley & Sons, Inc. (2002).

<sup>2</sup> For more discussion on this issue, we refer to C. Will's report: '*The confrontation between general relativity and experiments: 1998 update,*' McDonnell Center for the Space Sciences, Washington University. Recently there are also some articles discussing some features indicating incompleteness of GTR, for example *arXiv:gr-qc/0102056*, particularly related to the so-called Pioneer anomaly.

<sup>3</sup> See Munera (1998), who provides calculation to show Michelson-Morley experiments actually never were null. Since Michelson-Morley experiments are often considered as the building block of relativity theory (STR), we know what this article suggests.

<sup>4</sup> See Whittaker, E., *On the partial differential equations in mathematical physics*, Cambridge Univ., (1903).

<sup>5</sup> See articles by T. Van Flandern at <http://www.metaresearch.org>

<sup>6</sup> Of course, there are several other interpretations of the nature of the scalar field besides the 'phion condensate.' See for instance Barcelo *et al.* (2000), Dereli & Tucker (2000), Roberts (2001), Siegel (2002).

<sup>7</sup> See also other articles by Gibson at *arXiv.org:astro-ph/9904230, 9904237, 9904260, 9904284, 9904283, 9904317, 0003147, 9911264, 9904362, 9904269, 9904366, 9908335, 0002381*.

<sup>8</sup> Recently Castro, Granik, & El Naschie (2000) reintroduced this term to describe the exact dimension of our universe.

<sup>9</sup> There is already literature describing vortices in some cosmology phenomena, for instance Barge & Sommeria (1995) and also Chavanis (1999).

<sup>10</sup> In this regards, see Coles (2002), Neto *et al.* (2002), Rosu (1994), Zakir (1999).

<sup>11</sup> For a discussion on the meaning of interpreting Schrödinger equation as real fluid phenomena, see also Rosu (1994).

<sup>12</sup> See also Neto *et al.* (2002), Rosu (1994), Zakir (1999).

<sup>13</sup> See for instance P.V. Moniz (*arXiv:gr-qc/0011098*) and K. Akama (*arXiv:hep-th/0007001, hep-th/0001113*).

# A NOTE ON GEOMETRIC AND INFORMATION FUSION INTERPRETATION OF BELL'S THEOREM AND QUANTUM MEASUREMENT<sup>1</sup>

F. SMARANDACHE<sup>2</sup> AND V. CHRISTIANTO<sup>3</sup>

## 1. INTRODUCTION

It is generally accepted that Bell's theorem [1] is quite exact to describe the linear hidden-variable interpretation of quantum measurement, and hence 'quantum reality.' Therefore null result of this proposition implies that no hidden-variable theory could provide good explanation of 'quantum reality.'

Nonetheless, after further thought we can find that Bell's theorem is nothing more than another kind of abstraction of quantum observation based on a set of assumptions and propositions [7]. Therefore, one should be careful before making further generalization on the null result from experiments which are 'supposed' to verify Bell's theorem. For example, the most blatant assumption of Bell's theorem is that it takes into consideration only the classical statistical problem of chance of outcome  $A$  or outcome  $B$ , as result of adoption of Von Neumann's definition of 'quantum logic'. Another critic will be discussed here, i.e. that Bell's theorem is only a reformulation of statistical definition of correlation; therefore it is merely tautological. [5]

Therefore in the present paper we will discuss a few plausible extension of Bell's theorem:

- (a) Bayesian and Fuzzy Bayesian interpretation.
- (b) Information Fusion interpretation. In particular, we propose a modified version of Bell's theorem, which takes into consideration this multivalued outcome, in particular using the information fusion theory of Dezert-Smarandache [2, 3, 4]. We suppose that in quantum reality the outcome of  $P(A \cup B)$  and also  $P(A \cap B)$  shall also be taken into consideration. This is where DSmT theory could be found useful. [2]
- (c) Geometric interpretation, using a known theorem connecting geometry and imaginary plane. In turn, this leads us to 8-dimensional extended-Minkowski metric.
- (d) As an alternative to this geometric interpretation, we submit the viewpoint of photon fluid as medium for quantum interaction. This proposition leads us to Gross-Piteavskii equation which is commonly used to describe bose condensation phenomena. In turn we provide a route where Maxwell equations and Schrodinger equation could be deduced from Gross-Piteavskii equation by using known algebra involving bi-quaternion number. In our

---

<sup>1</sup>. Note: The notion 'hronir wave' introduced here was inspired from Borges' Tlon, Uqbar, Orbis Tertius.

opinion, this new proposition provides us a physical mechanism of quantum interaction, beyond conventional ‘quantum algebra’ which hides causal explanation.

By discussing these various approaches, we use an expanded logic beyond ‘yes’ or ‘no’ type logic [3]. In other words, there could be new possibilities to describe quantum interaction: ‘both can be wrong’, or ‘both can be right’, as described in Table 1 below:

TABLE 1. Going beyond classical logic view of QM

Alternative	Bell’s theorem	Implications	Special relativity
QM is nonlocal	Invalid	Causality breaks down; Observer determines the outcome	Is not always applicable
QM is local with hidden variable	Valid	Causality preserved; The moon is there even without observer.	No interaction can exceed the speed of light
Both can be right	Valid, but there is a way to explain QM without violating Special Relativity	QM, special relativity and Maxwell electromagnetic theory can be unified. New worldview shall be used.	Can be expanded using 8-dimensional Minkowski metric with imaginary plane
Both can be wrong	Invalid, and so Special Relativity is. We need a new theory	New nonlocal QM theory is required, involving quantum potential	Is not always applicable

It could be expected that a combined interpretation represents multiple-facets of quantum reality. And hopefully it could bring better understanding on the physical mechanism beneath quantum measurement, beyond simple algebraic notions. Further experiments are of course recommended in order to verify or refute this proposition.

## 2. BELL’S THEOREM. BAYESIAN AND FUZZY BAYESIAN INTERPRETATION

Despite widespread belief of its ability to describe hidden-variables of quantum reality [1], it shall be noted that Bell’s theorem starts with a set of assumptions inherent in its formulation. It is assumed that each pair of particles possesses a particular value of  $\lambda$ , and we define quantity  $p(\lambda)$  so that probability of a pair being produced between  $\lambda$  and  $\lambda + d\lambda$  is  $p(\lambda)d\lambda$ . It is also assumed that this is normalized so that:

$$\int p(\lambda)d\lambda = 1. \quad (1)$$

Further analysis shows that the integral that measures the correlation between two spin components that are at an angle of  $(\delta - \phi)$  with each other, is therefore equal to  $C''(\delta - \phi)$ . We can therefore write:

$$|C''(\phi) - C''(\delta)| - C''(\delta - \phi) \leq 1 \quad (2)$$

which is known as Bell's theorem, and it was supposed to represent any local hidden-variable theorem. But it shall be noted that actually this theorem cannot be tested completely because it assumes that all particle pairs have been detected. In other words, we find that a hidden assumption behind Bell's theorem is that it uses classical probability assertion [12], which may or may be not applicable to describe Quantum Measurement.

It is worth noting here that the standard interpretation of Bell's theorem includes the use of Bayesian posterior probability [13]:

$$P(\alpha | x) = \frac{p(\alpha)p(x | \alpha)}{\sum_{\beta} p(\beta)p(x | \beta)}. \quad (3)$$

As we know Bayesian method is based on classical two-valued logic. In the meantime, it is known that the restriction of classical propositional calculus to a two-valued logic has created some interesting paradoxes. For example, the Barber of Seville has a rule that all and only those men who do not shave themselves are shaved by the barber. It turns out that the only way for this paradox to work is if the statement is both *true and false simultaneously*. [14]. This brings us to *fuzzy Bayesian approach* [14] as an extension of (3):

$$P(s_i | \underline{M}) = \frac{p(\underline{M} | s_i)p(s_i)}{p(\underline{M})}. \quad (4)$$

Where [14, p. 339]:

$$p(\underline{M} | s_i) = \sum_{k=1}^r p(x_k | s_i)\mu_{\underline{M}}(x_k). \quad (5)$$

Nonetheless, it should also be noted here that there is shortcoming of this Bayesian approach. As Kracklauer points out, Bell's theorem is nothing but a reformulation of statistical definition of correlation [5]:

$$\text{Corr}(A, B) = \frac{\langle |AB| \rangle - \langle A \rangle \langle B \rangle}{\sqrt{\langle A^2 \rangle \langle B^2 \rangle}}. \quad (6)$$

When  $\langle A \rangle$  or  $\langle B \rangle$  equals to zero and  $\langle A^2 \rangle \langle B^2 \rangle = 1$  then equation (6) reduces to Bell's theorem. Therefore as such it could be considered as merely tautological [5].

### 3. INFORMATION FUSION INTERPRETATION OF BELL'S THEOREM. DSMT MODIFICATION

In the context of physical theory of information [8], Barrett has noted that "there ought to be a set theoretic language which applies directly to all quantum interactions." This is because the idea of a bit is itself straight out of *classical set theory*, the definitive and unambiguous assignment of an element of the set  $\{0, 1\}$ , and so the assignment of an information content of the photon itself is fraught with the same difficulties [8]. Similarly, the problem becomes more adverse because the fundamental basis of conventional statistical theories is the same classical set  $\{0, 1\}$ .

Not only that, there is also criticism over the use of Bayesian approach, i.e.: [13]

- (a) In real world, neither class probabilities nor class densities are precisely known;
- (b) This implies that one should adopt a parametric model for the class probabilities and class densities, and then use empirical data.
- (c) Therefore, in the context where multiple sensors can be used, information fusion approach could be a better alternative to Bayes approach.

In other words, we should find an extension to standard proposition in statistical theory [8, p.388]:

$$\begin{aligned} P(AB | C) &= P(A | BC)P(B | C) \\ &= P(B | AC)P(A | C) \end{aligned} \quad (7)$$

$$P(A | B) + P(\bar{A} | B) = 1. \quad (8)$$

Such an extension is already known in the area of information fusion [2], known as Dempster-Shafer theory:

$$m(A) + m(B) + m(A \cup B) = 1. \quad (9)$$

Interestingly, Chapline [13] noted that neither Bayesian theory nor Dempster-Shafer could offer insight on how to minimize overall energy usage in the network. In the meantime, Dezert-Smarandache (DSmT) [2] introduced further improvement of Dempster-Shafer theory by taking into consideration chance to observe intersection between  $A$  and  $B$ :

$$m(A) + m(B) + m(A \cup B) + m(A \cap B) = 1. \quad (10)$$

Therefore, introducing this extension from equation (10) into equation (2), one finds a modified version of Bell's theorem in the form:

$$|C''(\phi) - C''(\delta)| - C''(\delta - \phi) + C''(\delta \cup \phi) + C''(\delta \cap \phi) \leq 1 \quad (11)$$

which could be called as modified Bell's theorem according to Dezert-Smarandache (DSmT) theory [2]. Its direct implications suggest that it could be useful to include more sensors in order to capture various possibilities beyond simple  $\{0, 1\}$  result, which is typical in Bell's theorem.

Further generalization of DSmT theory (10) is known as Unification of Fusion Theories [15, 16, 17]:

$$m(A) + m(B) + m(A \cup B) + m(A \cap B) + m(\bar{A}) + m(\bar{B}) = 1 \quad (12)$$

where  $\bar{A}$  is the complement of  $A$  and  $\bar{B}$  is the complement of  $B$  (if we consider the set theory).

(But if we consider the logical theory then  $\bar{A}$  is the negation of  $A$  and  $\bar{B}$  is the negation of  $B$ . The set theory and logical theory in this example are equivalent, hence doesn't matter which one we use from them.) In equation (12) above we have a complement/negation for  $A$ . We might define the  $\bar{A}$  as the entangle of particle  $A$ . Hence we could expect to further extend Bell's inequality considering UFT; nonetheless we leave this further generalization for the reader.

Of course, new experimental design is recommended in order to verify and to find various implications of this new proposition.

4. AN ALTERNATIVE GEOMETRIC INTERPRETATION OF BELL-TYPE MEASUREMENT. GROSS-PITAEVSKII EQUATION AND THE ‘HRONIR WAVE’

Apart from the aforementioned Bayesian interpretation of Bell’s theorem, we can consider the problem from purely geometric viewpoint. As we know, there is linkage between geometry and algebra with imaginary plane [18]:

$$x + iy = \rho e^{i\phi}. \quad (13)$$

Therefore one could expect to come up with geometrical explanation of quantum interaction, provided we could generalize the metric using imaginary plane:

$$X + iX' = \rho e^{i\phi}. \quad (14)$$

Interestingly, Amoroso and Rauscher [19] have proposed exactly the same idea, i.e. generalizing Minkowski metric to become 8-dimensional metric which can be represented as:

$$Z^\mu = X_{re}^\mu + iX_{im}^\mu = \rho e^{i\phi}. \quad (15)$$

A characteristic result of this 8-dimensional metric is that ‘space separation’ vanishes, and quantum-type interaction could happen in no time.

Another viewpoint could be introduced in this regard, i.e. that the wave nature of photon arises from ‘photon fluid’ medium, which serves to enable photon-photon interaction. It has been argued that this photon-fluid medium could be described using Gross-Pitaevskii equation [20]. In turns, we could expect to ‘derive’ Schrodinger wave equation from the Gross-Pitaevskii equation.

It will be shown, that we could derive Schrodinger wave equation from Gross-Pitaevskii equation. Interestingly, a new term similar to equation (13) arises here, which then we propose to call it ‘hronir wave’. Therefore one could expect that this ‘hronir wave’ plays the role of ‘invisible light’ as postulated by Maxwell long-time ago.

Consider the well-known Gross-Pitaevskii equation in the context of superfluidity or superconductivity [21]:

$$i\hbar \frac{\partial \Psi}{\partial t} = -\frac{\hbar^2}{2m} \Delta \Psi + (V(x) - \gamma |\Psi|^{p-1}) \Psi, \quad (16)$$

where  $p < 2N/(N - 2)$  if  $N \geq 3$ . In physical problems, the equation for  $p = 3$  is known as Gross-Pitaevskii equation. This equation (16) has standing wave solution quite similar to Schrodinger equation, in the form:

$$\Psi(x, t) = e^{-iEt/\hbar} \cdot u(x). \quad (17)$$

Substituting equation (17) into equation (16) yields:

$$-\frac{\hbar^2}{2m} \Delta u + (V(x) - E)u = |u|^{p-1}u, \quad (18)$$

which is nothing but time-independent linear form of Schrodinger equation, except for term  $|u|^{p-1}$  [21]. In case the right-hand side of this equation is negligible, equation (18) reduces to standard Schrodinger equation. Using Maclaurin series expansion, we get for (17):

$$\Psi(x, t) = \left( 1 - iEt/\hbar + \frac{(Et/\hbar)^2}{2!} + \frac{(-iEt/\hbar)^3}{3!} + \dots \right) \cdot u(x). \quad (19)$$

Therefore we can say that standing wave solution of Gross-Pitaevskii equation (17) is similar to standing wave solution of Schrodinger equation ( $u$ ), except for

nonlinear term which comes from Maclaurin series expansion (19). By neglecting third and other higher order terms of equation (19), one gets an approximation:

$$\Psi(x, t) = [1 - iEt/\hbar] \cdot u(x). \quad (20)$$

Note that this equation (20) is very near to hyperbolic form  $z = x + iy$  [18]. Therefore one could conclude that standing wave solution of Gross-Pitaevskii equation is merely an extension from ordinary solution of Schrodinger equation into Cauchy (imaginary) plane. In other words, there shall be 'hronir wave' part of Schrodinger equation in order to describe Gross-Pitaevskii equation. We will use this result in the subsequent section, but first we consider how to derive bi-quaternion from Schrodinger equation.

It is known that solutions of Riccati equation are logarithmic derivatives of solutions of Schrodinger equation, and *vice versa* [22]:

$$u'' + vu = 0. \quad (21)$$

Bi-quaternion of differentiable function of  $x = (x_1, x_2, x_3)$  is defined as [22]:

$$Dq = -\text{div}(q) + \text{grad}(q_o) + \text{rot}(q). \quad (22)$$

By using alternative representation of Schrodinger equation [22]:

$$[-\Delta + u]f = 0, \quad (23)$$

where  $f$  is twice differentiable, and introducing quaternion equation:

$$Dq + q^2 = -u. \quad (24)$$

Then we could find  $q$ , where  $q$  is purely vectorial differentiable bi-quaternion valued function [22].

We note that solutions of (23) are related to (24) as follows [22]:

\*\* For any nonvanishing solution  $f$  of (23), its logarithmic derivative:

$$q = \frac{Df}{f}, \quad (25)$$

is a solution of equation (24), and *vice versa*. [22]

Furthermore, we also note that for an arbitrary scalar twice differentiable function  $f$ , the following equality is permitted [22]:

$$[-\Delta + u]f = [D + M^h][D - M^h]f, \quad (26)$$

provided  $h$  is solution of equation (24).

Therefore we can summarize that given a particular solution of Schrodinger equation (23), the general solution reduces to the first order equation [22, p.9]:

$$[D + M^h]F = 0, \quad (27)$$

where

$$h = \frac{D\sqrt{\varepsilon}}{\varepsilon}. \quad (28)$$

Interestingly, equation (27) is equivalent to **Maxwell equations**. [22] Now we can generalize our result from the preceding section, in the form of the following conjecture:



**Conjecture 1.** *Given a particular solution of Schrodinger equation (23), then the approximate solution of Gross-Pitaevskii equation (16) reduces to the first order equation:*

$$[1 - iEt/\hbar][D + M^h]F = 0. \quad (29)$$

Therefore we can conclude here that there is neat linkage between Schrodinger equation, Maxwell equation, Riccati equation via biquaternion expression [22, 23, 24]. And approximate solution of Gross-Pitaevskii equation is similar to solution of Schrodinger equation, except that it exhibits a new term called here ‘*the hronir wave*’ (29).

Our proposition is that considering equation (29) has imaginary plane wave, therefore it could be expected to provided ‘physical mechanism’ of quantum interaction, in the same sense of equation (13). Further experiments are of course recommended in order to verify or refute this proposition.

## 5. SOME ASTROPHYSICAL IMPLICATIONS OF GROSS-PITAEVSKII DESCRIPTION

Interestingly, Moffat [25, p.9] has also used Gross-Pitaevskii in his ‘phion condensate fluid’ to describe CMB spectrum. Therefore we could expect that this equation will also yield interesting results in cosmological scale.

Furthermore, it is well-known that Gross-Pitaevskii equation could exhibit *topologically* non-trivial vortex solutions [26, 27], which can be expressed as quantized vortices:

$$\oint p \bullet dr = N_v 2\pi\hbar. \quad (30)$$

Therefore an implication of Gross-Pitaevskii equation [25] is that topologically quantized vortex could exhibit in astrophysical scale. In this context we submit the viewpoint that this proposition indeed has been observed in the form of Tiftt’s quantization [28, 29]. The following description supports this assertion of topological quantized vortices in astrophysical scale.

We start with standard definition of Hubble law [28]:

$$z = \frac{\delta\lambda}{\lambda} = \frac{Hr}{c}. \quad (31)$$

Or

$$r = \frac{c}{H}z. \quad (32)$$

Now we suppose that the major parts of redshift data could be explained via Doppler shift effect, therefore [28]:

$$z = \frac{\delta\lambda}{\lambda} = \frac{v}{c}. \quad (33)$$

In order to interpret Tiftt’s observation of quantized redshift corresponding to quantized velocity 36.6 km/sec and 72.2 km/sec, then we could write from equation (33):

$$\frac{\delta v}{c} = \delta z = \delta \left( \frac{\delta\lambda}{\lambda} \right). \quad (34)$$

Or from equation (32) we get:

$$\delta r = \frac{c}{H} \delta z. \quad (35)$$

In other words, we submit the viewpoint that Tifft's observation of quantized redshift implies a quantized distance between galaxies [28], which could be expressed in the form:

$$r_n = r_o + n(\delta r). \quad (35a)$$

It is proposed here that this equation of quantized distance (35a) is resulted from topological quantized vortices (30), and agrees with Gross-Pitaevskii (quantum phion condensate) description of CMB spectrum [25]. Nonetheless, further observation is recommended in order to verify the above proposition.

#### CONCLUDING REMARKS

In the present paper we review a few extension of Bell's theorem which could take into consideration chance to observe outcome beyond classical statistical theory, in particular using the information fusion theory. A new geometrical interpretation of quantum interaction has been considered, using Gross-Pitaevskii equation. Interestingly, Moffat [25] also considered this equation in the context of cosmology.

It is recommended to conduct further experiments in order to verify and also to explore various implications of this new proposition, including perhaps for the quantum computation theory [8, 13].

#### ACKNOWLEDGMENT

The writers would like to thank to Profs. C. Castro, J. Dezert, P. Vallin, T. Love, D. Rabounski, and A. Kaivarainen for valuable discussions. The new term 'hronir wave' introduced here was inspired from Borges' *Tlon, Uqbar, Orbis Tertius*. Hronir wave is defined here as 'almost symmetrical mirror' of Schrodinger-type wave.

#### REFERENCES

- [1] Shimony, A., <http://plato.stanford.edu/entries/bell-theorem/> (2004), [1a] <http://plato.stanford.edu/entries/kochen-specker/>
- [2] Smarandache, F., & J. Dezert, *Advances and Applications of of DSMT for Information Fusion*, American Research Press, Rehoboth (2004) 438p.
- [3] Smarandache, F., "An introduction to the Neutrosophic probability applied in quantum physics," (Bulletin of Pure and Applied Sciences) , Physics, 13-25, Vol. 22D, No. 1 (2003) 11 p; [www.gallup.unm.edu/~smarandache/physics.htm](http://www.gallup.unm.edu/~smarandache/physics.htm).
- [4] Smarandache, F., & V. Christianto, *Multivalued Logic, Neutrosophy and Schrodinger equation*, Hexis-Phoenix (2005).
- [5] Kracklauer, A., 'La theorie de Bell, est-elle la plus grande meprise de l'histoire de la physique?,' *Annales de la Fondation Louis de Broglie*, **25** (2000) 193
- [6] Aharonov, Y., *et al.*, [arXiv:quant-ph/0311155](https://arxiv.org/abs/quant-ph/0311155) (2003).
- [7] Rosu, H. C., [arXiv:gr-qc/9411035](https://arxiv.org/abs/gr-qc/9411035) (1994) p. 2-8.
- [8] Zurek, W. (ed.), *Complexity, Entropy and the Physics of Information*, Santa Fe Institute Studies, Addison-Wesley Publ. (1990) 378.
- [9] Schrieffer, J. R., "Macroscopic quantum phenomena from pairing in superconductors," Lecture, December 11th, 1972.
- [10] Anandan, J. S., in *Quantum Coherence and Reality, Proc. Conf. Fundamental Aspects of Quantum Theory*, Columbia SC., edited by J.S. Anandan & J.L. Safko, (World Scientific 1994). [arXiv:gr-qc/9504002](https://arxiv.org/abs/gr-qc/9504002) (1995).
- [11] Goldstein, S., "Quantum Theory without Observers – Part One," *Physics Today*, March 1998, p. 42-46
- [12] Pitowski, I., [arXiv:quant-ph/0510095](https://arxiv.org/abs/quant-ph/0510095) (2005).
- [13] Chapline, G., [arXiv:adap-org/9906002](https://arxiv.org/abs/adap-org/9906002) (1999). Also [13a] [arXiv:quant-ph/9912019](https://arxiv.org/abs/quant-ph/9912019) (1999), [13b] A. Granik, G. Chapline, [arXiv:quant-ph/0302013](https://arxiv.org/abs/quant-ph/0302013) (2003), [13c] [www.whatsnextnetwork.com/technology/index.php/2006/03/](http://www.whatsnextnetwork.com/technology/index.php/2006/03/)

- [14] Ross, T. J., *Fuzzy Logic with Engineering Applications*. McGraw-Hill, Inc. (1995) 196–197, 334–341
- [15] Smarandache, F. “Unification of Fusion Theories (UFT)”, *International Journal of Applied Mathematics & Statistics*, Roorkee, India, Vol. 2, 1-14, December 2004.
- [16] Smarandache, F., “An In-Depth Look at Information Fusion Rules and Unification of Fusion Theories”, Invited speech at NASA Langley Research Center, Hampton, VA, USA, November 5, 2004.
- [17] Smarandache, F. “Unification of the Fusion Theory (UFT)”, Invited speech at NATO Advance Study Institute, Albena, Bulgaria, 16–27 May, 2005.
- [18] Gogberashvili, M., [arXiv:hep-th/0212251](https://arxiv.org/abs/hep-th/0212251) (2002) 4–5
- [19] Rauscher, E. A., & R. Amoroso, The physical implications of multidimensional geometries and measurement, *Inter. J. of Comp. Anticipatory Systems*, D. Dubois (ed.) (2006)
- [20] Chiao, R., *et al.*, [arXiv:physics/0309065](https://arxiv.org/abs/physics/0309065) (2003).
- [21] Dinu, [arXiv:math.AP/0511184](https://arxiv.org/abs/math.AP/0511184) (2005)
- [22] Kravchenko, V., [arXiv:math.AP/0408172](https://arxiv.org/abs/math.AP/0408172) (2004)
- [23] Lipavsky, P., *et al.*, [arXiv:cond-mat/0111214](https://arxiv.org/abs/cond-mat/0111214) (2001)
- [24] de Haas, E. P., “A renewed theory of electrodynamics in the framework of Dirac ether,” PIRT (2005), <http://www.physics.nl>
- [25] Moffat, J., [arXiv:astro-ph/0602607](https://arxiv.org/abs/astro-ph/0602607) (2006)
- [26] Smarandache, F., & V. Christianto, *Progress in Physics* Vol.2 No. 2 (2006), <http://www.ptep-online.com>
- [27] Fischer, U., [arXiv:cond-mat/9907457](https://arxiv.org/abs/cond-mat/9907457) (1999); [27a] [arXiv:cond-mat/0004339](https://arxiv.org/abs/cond-mat/0004339)
- [28] Humphreys, *TJ Archive* Vol.16, <http://answersingenesis.org/tj/v16/i2/index.asp> (2002)
- [29] Setterfield, B., <http://www.journaloftheoretics.com>

*First version: 8th June 2006, 1st revision 28th Aug. 2006.*

<sup>2</sup>. DEPARTMENT OF MATHEMATICS, UNIVERSITY OF NEW MEXICO, NM 87301, USA,  
*E-mail address:* [smarand@unm.edu](mailto:smarand@unm.edu)

<sup>3</sup>. [HTTP://WWW.SCIPRINT.ORG](http://WWW.SCIPRINT.ORG),  
*E-mail address:* [admin@sciprint.org](mailto:admin@sciprint.org)

# Plausible explanation of quantization of intrinsic redshift from Hall effect and Weyl quantization

F. Smarandache<sup>1</sup> & V. Christianto<sup>2</sup>

<sup>1</sup>. Department of Mathematics, University of New Mexico, NM 87301, USA, email: smarand@unm.edu

<sup>2</sup>. <http://reachme.at/coolbit>, email: vxianto@yahoo.com

## Introduction

In a recent paper by Moffat [1] it is shown that quantum phion condensate model with Gross-Pitaevskii equation yields an approximate fit to data corresponding to CMB spectrum, and it also yields a modified Newtonian acceleration law which is in good agreement with galaxy rotation curve data. It seems therefore interesting to extend further this hypothesis to explain quantization of redshift, as shown by Tift *et al.* [2][6][7]. We also argue in other paper that this redshift quantization could be explained as signature of topological quantized vortices, which also agrees with Gross-Pitaevskiiian description [3][5].

Nonetheless, there is remaining question in this quantized vortices interpretation, i.e. how to provide explanation of ‘intrinsic redshift’ argument by Bell [6]. In the present paper, we argue that it sounds reasonable to interpret the intrinsic redshift data from the viewpoint of rotating Hall effect, i.e. rotational motion of clusters of galaxies exhibit quantum Hall effect which can be observed in the form of ‘intrinsic redshift’. While this hypothesis is very new, it could be expected that we can draw some prediction, including possibility to observe small ‘blue-shift’ effect generated by antivortex part of the Hall effect. [5a]

Another possibility is to explain redshift quantization from the viewpoint of Weyl-Moyal quantization theory [25]. It is shown that Schrödinger equation can be derived from Weyl approach [8], therefore quantization in this sense comes from ‘graph’-type quantization. In large scale phenomena like galaxy redshift quantization one could then ask whether there is possibility of ‘super-graph’ quantization.

Further observation is of course recommended in order to verify or refute the propositions outlined herein.

## Interpreting quantized redshift from Hall effect. Cosmic String

In a recent paper, Moffat [1, p.9] has used Gross-Pitaevskii in conjunction with his ‘*phion condensate fluid*’ model to describe CMB spectrum data. Therefore we could expect that this equation will also yield interesting results in galaxies scale. See also [1b][1c][13] for other implications of low-energy phion fluid model.

Interestingly, it could be shown, that we could derive (approximately) Schrödinger wave equation from Gross-Pitaevskii equation. Consider the

well-known Gross-Pitaevskii equation in the context of superfluidity or superconductivity [14]:

$$i\hbar \frac{\partial \Psi}{\partial t} = -\frac{\hbar^2}{2m} \Delta \Psi + (V(x) - \gamma |\Psi|^{p-1}) \Psi, \quad (1)$$

where  $p < 2N/(N-2)$  if  $N \geq 3$ . In physical problems, the equation for  $p=3$  is known as Gross-Pitaevskii equation. This equation (1) has standing wave solution quite similar to solution of Schrödinger equation, in the form:

$$\Psi(x, t) = e^{-iEt/\hbar} u(x) \quad (2)$$

Substituting equation (2) into equation (1) yields:

$$-\frac{\hbar^2}{2m} \Delta u + (V(x) - E)u = \gamma |u|^{p-1} u, \quad (3)$$

which is nothing but a time-independent linear form of Schrödinger equation, except for term  $|u|^{p-1}$  [14]. If the right-hand side of this equation is negligible, equation (3) reduces to standard Schrödinger equation.

Now it is worth noting here that from Nottale *et al.* we can derive a gravitational equivalent of Bohr radius from generalized Schrödinger equation. [4] Therefore we could also expect a slight deviation of this gravitational Bohr radius in we consider Gross-Pitaevskii equation instead of generalized Schrödinger equation.

According to Moffat, the phion condensate model implies a modification of Newtonian acceleration law to become [1, p.11]:

$$a(r) = -\frac{G_\infty M}{r^2} + K \frac{\exp(-\mu_\phi r)}{r^2} (1 + \mu_\phi r) \quad (4)$$

Where

$$G_\infty = G \left[ 1 + \sqrt{\frac{M_0}{M}} \right] \quad (5)$$

Therefore we can conclude that the use of phion condensate model implies a modification of Newton gravitational constant, G, to become (5). Plugging in this new equation (5) into a Nottale's gravitational Bohr radius equation [4] yields:

$$r_n \approx n^2 \frac{GM}{v_o^2} \left[ 1 + \sqrt{\frac{M_0}{M}} \right] \approx \chi \cdot n^2 \frac{GM}{v_o^2} \quad (6)$$

where n is integer (1,2,3...) and:

$$\chi = \left[ 1 + \sqrt{\frac{M_0}{M}} \right] \quad (6a)$$

Therefore we conclude that --provided the higher order Yukawa term of equation (4) could be neglected-- one has a *modified* gravitational Bohr-radius in the form of (6). It can be shown (elsewhere) that using similar argument one could expect to explain a puzzling phenomenon of *receding Moon* at a constant rate of  $\pm 1.5''$  per year. And from this observed fact one could get an estimate of this  $\chi$  factor. It is more interesting to note here, that a number of *coral reef* data also seems to support the same idea of modification factor in equation (5), but discussion of this subject deserves another paper.

A somewhat similar idea has been put forward by Masreliez [18] using the metric:

$$ds^2 = e^{\alpha\beta} \left[ dx^2 + dy^2 + dz^2 - (ic \cdot dt)^2 \right] \quad (7)$$

Another alternative of this metric has been proposed by Socoloff & Starobinski [19] using multi-connected hypersurface metric:

$$ds^2 = dx^2 + e^{-2x} (dy^2 + dz^2) \quad (8)$$

With boundaries:  $e^{-x} = \Lambda$ .

Therefore one can conclude that the use of phion condensate model has led us to a form of expanding metric, which has been discussed by a few authors.

Furthermore, it is well-known that Gross-Pitaevskii equation could exhibit *topologically* non-trivial vortex solutions [4][5], which also corresponds to quantized vortices:

$$\oint p \times dr = N_v 2\pi\hbar \quad (9)$$

Therefore an implication of Gross-Pitaevskii equation [1] is that topologically quantized vortex could exhibit in astrophysical scale. In this context we submit the viewpoint that this proposition indeed has been observed in the form of Tifft's redshift quantization [2][6]:

$$\delta r = \frac{c}{H} \delta z \quad (10)$$

In other words, we submit the viewpoint that Tifft's observation of quantized redshift implies a quantized distance between galaxies [2][5], which could be expressed in the form:

$$r_n = r_o + n(\delta r) \quad (11)$$

where n is integer (1,2,3,...) similar to quantum number. Because it can be shown using standard definition of Hubble law that redshift quantization implies quantized distance between galaxies in the same cluster, then one could say that this equation of quantized distance (11) is a result of *topological* quantized vortices (9) in astrophysical scale [5]; and it agrees with Gross-Pitaevskii (quantum phion condensate) description of CMB spectrum [1]. It is perhaps more interesting if we note here, that from (10) then we also get an equivalent expression of (11):

$$\frac{c}{H} z_n = \frac{c}{H} z_o + n \left( \frac{c}{H} \delta z \right) \quad (12)$$

Or

$$z_n = z_o + n(\delta z) \quad (13)$$

Or

$$z_n = z_o \left[ 1 + n \left( \frac{\delta z}{z_o} \right) \right] \quad (13a)$$

Nonetheless, there is a problem here, i.e. how to explain intrinsic redshift related to Tifft quantization as observed in Fundamental Plane clusters and also from various quasars data [6][6a]:

$$z_{iQ} = z_f [N - 0.1M_N] \quad (13b)$$

Where  $z_f=0.62$  is assumed to be a fundamental redshift constant, and N (=1,2,3...), and M is function of N.[6a] Meanwhile, it is interesting to note

here similarity between equation (13b) and (13a). Here, the number  $M$  seems to play a role similar to second quantum number in quantum physics. [7]

Now we will put forward an argument that intrinsic redshift quantization (13b) could come from rotating quantum Hall effect. [5a]

It is argued by Fischer [5a] that “Hall quantization is of necessity derivable from a *topological quantum number* related to this (quantum) coherence.” He used total particle momentum [5a]:

$$p = mv + m\Omega \times r + qA \quad (14)$$

The uniqueness condition of the collective phase represented in (9) then leads, if we take a path in the bulk of electron liquid, for which the integral of  $mv$  can be neglected, to the quantization of the sum of a *Sagnac flux*, and the magnetic flux [5a]:

$$\Phi = q \oint A \times dr + m \oint \Omega \times r \times dr = \iint B \times dS = N_v 2\pi\hbar \quad (15)$$

This flux quantization rule corresponds to the fact that a *vortex* is fundamentally characterised by the winding number  $N$  alone [5a]. In this regard the vortex could take the form of cosmic string [22]. Now it is clear from (15) that quantized vortices could be formed by different source of flux.

After a few more reasonable assumptions one could obtain a generalised Faraday law, which in rotating frame will give in a non-dissipative Hall state the quantization of Hall conductivity [5a].

Therefore one could observe that it is quite natural to interpret the quantized distance between galaxies (11) as an implication of quantum Hall effect in rotating frame (15). While this proposition requires further observation, one could think of it in particular using known analogy between condensed matter physics and cosmology phenomena. [10][22] If this proposition corresponds to the facts, then one could think that redshift quantization is an imprint of generalized quantization in various scales from microphysics to macrophysics, just as Tifft once put it [2]:

*“The redshift has imprinted on it a pattern that appears to have its origin in microscopic quantum physics, yet it carries this imprint across cosmological boundaries.”*

In the present paper, Tifft’s remark represents natural implication of topological quantization, which could be formed at any scale [5]. We will explore further this proposition in the subsequent section, using Weyl quantization.

Furthermore, while this hypothesis is very new, it could be expected that we can draw some new prediction, for instance, like possibility to observe small ‘blue-shift’ effect generated by the Hall effect from antivortex-galaxies. [23] Of course, in order to observe such a ‘blue-shift’ one shall first exclude other anomalous effects of redshift phenomena [6].

One could expect that further observation in particular in the area of low-energy neutrino will shed some light on this issue.[20] In this regard, one could view that the Sun is merely a remnant of a neutron star in the past, therefore it could be expected that it also emits neutrino similar to neutron star [21].

### **An alternative interpretation of astrophysical quantization from Weyl quantization. Graph and quantization.**

An alternative way to interpret the above proposition concerning topological quantum number and topological quantization [5a], is by using Weyl quantization.

In this regards, Castro [8, p.5] has shown recently that one could derive Schrödinger equation from Weyl geometry using continuity equation:

$$\frac{\partial \rho}{\partial t} + \frac{1}{\sqrt{g}} \partial_i (\sqrt{g} \rho v^i) \quad (16)$$

And Weyl metric:

$$R_{Weyl} = (d-1)(d-2)(A_k A^k) - 2(d-1)\partial_k A^k \quad (17)$$

Therefore one could expect to explain astrophysical quantization using Weyl method in lieu of using generalised Schrödinger equation as Nottale did [4]. To our knowledge this possibility has never been explored before elsewhere.

For instance, it can be shown that one can obtain Bohr-Sommerfeld type quantization rule from Weyl approach [24, p.12], which for kinetic plus potential energy will take the form:

$$2\pi N \hbar = \sum_{j=0}^{\infty} \hbar^j S_j(E) \quad (18)$$

Which can be solved by expressing  $E = \sum \hbar^k E_k$  as power series in  $\hbar$ . [24]. Now equation (9) could be rewritten as follows:

$$\oint p \times dr = N_v 2\pi \hbar = \sum_{j=0}^{\infty} \hbar^j S_j(E) \quad (19)$$

Or if we consider quantum Hall effect, then equation (15) can be used instead of equation (9), which yields:

$$\Phi = q \oint A \times dr + m \oint \Omega \times r \times dr = \iint B \times dS = \sum_{j=0}^{\infty} \hbar^j S_j(E) \quad (19a)$$

The above method is known as ‘graph kinematic’ [25] or Weyl-Moyal’s deformation quantization [26]. We could also expect to find Hall effect quantization from this deformation quantization method.

Consider a harmonic oscillator, which equation can be expressed in the form of deformation quantization instead of Schrödinger equation [26]:

$$\left( \left( x + \frac{i\hbar}{2} \partial_p \right)^2 + \left( p - \frac{i\hbar}{2} \partial_x \right)^2 - 2E \right) f(x, p) = 0 \quad (20)$$

This equation could be separated to become two simple PDEs. For imaginary part one gets [26]:

$$(x \partial_p - p \partial_x) f = 0 \quad (21)$$

Now, considering Hall effect, one can introduce our definition of total particle momentum (14), therefore equation (21) may be written:

$$(x \partial_p - (mv + m\Omega \times r + qA) \partial_x) f = 0 \quad (22)$$

Our proposition here is that in the context of deformation quantization it is possible to find quantization solution of harmonic oscillator without Schrödinger equation. And because it corresponds to graph kinematic [25], generalized Bohr-Sommerfeld quantization rule for quantized vortices (19) in astrophysical scale could be viewed as signature of ‘super-graph’ quantization.



This proposition, however, deserves further theoretical considerations. Further experiments are also recommended in order to verify and explore further this proposition.

### Concluding remarks

In a recent paper, Moffat [1] has used Gross-Pitaevskii in his ‘phion condensate fluid’ to describe CMB spectrum data. We extend this proposition to explain Tiffit redshift quantization from the viewpoint of topological quantized vortices. In effect we consider that the intrinsic redshift quantization could be interpreted as result of Hall effect in rotating frame.

Another alternative to explain redshift quantization is to consider quantized vortices from the viewpoint of Weyl quantization which could yield Bohr-Sommerfeld quantization.

It is recommended to conduct further observation in order to verify and also to explore various implications of our propositions as described herein.

### Acknowledgment

The writers would like to thank to Profs. C. Castro, T. Love, E. Scholz, D. Rabounski, and A. Kaivarainen for valuable discussions.

### References

- [1] Moffat, J., arXiv:astro-ph/0602607 (2006); [1a] Consoli, M., arXiv:hep-ph/0109215 (2001); [1b] Consoli, M. *et al*, arXiv:physics/0306094
- [2] Humphreys, *TJ Archive* Vol.16 <http://answersingenesi.org/tj/v16/i2/> (2002) [http://www.answersingenesi.org/home/area/magazines/tj/docs/TJv16n2\\_CEN\\_TRE.pdf](http://www.answersingenesi.org/home/area/magazines/tj/docs/TJv16n2_CEN_TRE.pdf)
- [3] Smarandache, F., & V. Christianto, ‘A note on geometric and information fusion interpretation of Bell theorem and quantum measurement,’ submitted to *Progress in Physics* (2006), <http://www.ptep-online.com>
- [4] Smarandache, F., & V. Christianto, *Progress in Physics* Vol.2 No. 2 (Apr. 2006), <http://www.ptep-online.com>
- [5] Fischer, U., arXiv:cond-mat/9907457 (1999); [5a] arXiv:cond-mat/0004339
- [6] Bell, M.B., arXiv: astro-ph/0111123 (2001); [6a] Bell, M.B., [http://arxiv.org/PS\\_cache/astro-ph/pdf/0305/0305112.pdf](http://arxiv.org/PS_cache/astro-ph/pdf/0305/0305112.pdf); [6b] Bell, M.B., arXiv: astro-ph/0305060 (2003).
- [7] Setterfield, B., <http://www.journaloftheoretics.com>, www.setterfield.org
- [8] Castro, C. & J. Mahecha, ‘On Nonlinear Quantum Mechanics, Brownian motion, Weyl Geometry, and Fisher Information,’ *Progress in Physics* Vol.2 No. 1 (Jan. 2006), <http://www.ptep-online.com>
- [9] Schrieffer, J.R., “Macroscopic quantum phenomena from pairing in superconductors,” Lecture, December 11<sup>th</sup>, 1972.
- [10] Zurek, W. (ed.), in *Proc. Euroconference in Formation and Interaction of Topological Defects*, Plenum, 1995, arXiv :cond-mat/9502119 (1995).
- [11] Anandan, J.S., in *Quantum Coherence and Reality, Proc. Conf. Fundamental Aspects of Quantum Theory*, Columbia SC., edited by J.S. Anandan & J.L. Safko, (World Scientific 1994). arXiv:gr-qc/9504002 (1995).

- [12] Rauscher, E.A., & R. Amoroso, The physical implications of multidimensional geometries and measurement, *Inter. J. of Comp. Anticipatory Systems*, D. Dubois (ed.) (2006)
- [13] Chiao, R., *et al.*, arXiv:physics/0309065 (2003).
- [14] Dinu, arXiv:math.AP/0511184 (2005)
- [15] Kravchenko, V., arXiv:math.AP/0408172 (2004)
- [16] Lipavsky, P., *et al.*, arxiv:cond-mat/0111214 (2001)
- [17] de Haas, E.P., "A renewed theory of electrodynamics in the framework of Dirac ether," PIRT (2005), <http://www.physics.nl>
- [18] Masreliez, J., *Apeiron* Vol. 12 (2005)
- [19] Marc, L-R., & J-P. Luminet, arXiv:hep-th/9605010 (1996) 59, 116.
- [20] Lanou, R., arXiv:hep-ex/9808033 (1998).
- [21] Yakovlev, D., *et al.*, arXiv:astro-ph/0012122 (2001).
- [22] Volovik, G., arXiv:cond-mat/0507454 (2005).
- [23] Balents, L., *et al.*, arXiv:cond-mat/9903294 (1999).
- [24] Gracia-Saz, A., *Ann. Inst. Fourier*, Grenoble, Vol. 55, 5 (2005) 1001-1008.
- [25] Asribekov, V.L., arXiv:physics/0110026 (2001).
- [26] Zachos, C., arXiv:hep-th/0110114 (2001).

*First version: 18<sup>th</sup> Aug. 2006, 1<sup>st</sup> revision 21<sup>th</sup> Aug. 2006.*

# A New Wave Quantum Relativistic Equation from Quaternionic Representation of Maxwell-Dirac Isomorphism as an Alternative to Barut-Dirac Equation

V. Christianto\*

*V. Christianto Via Florentin Smarandache,  
Department of Mathematics, University of New Mexico Gallup, NM 87301, USA*

Reprinted with kind permission from EJTP editor

Received 5 November 2005, Accepted 5 January 2006, Published 20 September 2006

---

**Abstract:** It is known that Barut's equation could predict lepton and hadron mass with remarkable precision. Recently some authors have extended this equation, resulting in Barut-Dirac equation. In the present article we argue that it is possible to derive a new wave equation as alternative to Barut-Dirac's equation from the known exact correspondence (isomorphism) between Dirac equation and Maxwell electromagnetic equations via biquaternionic representation. Furthermore, in the present note we submit the viewpoint that it would be more conceivable if we interpret the *vierbein* of this equation in terms of superfluid velocity, which in turn brings us to the notion of topological electronic liquid. Some implications of this proposition include quantization of celestial systems. We also argue that it is possible to find some signatures of Bose-Einstein cosmology, which thus far is not explored sufficiently in the literature. Further experimental observation to verify or refute this proposition is recommended.

© Electronic Journal of Theoretical Physics. All rights reserved.

*Keywords: Relativistic Quantum Mechanics, Barut's equation, Barut-Dirac's equation*

*PACS (2006): 03.65.Pm, 03.65.Ca, 11.10.-z*

---

## 1. Introduction

It is known that Barut's equation could predict lepton and hadron mass with remarkable precision [1]. A plausible extension of Barut's equation is by using Barut-Dirac's model via inclusion of electron self-field. Furthermore, a number of authors has extended

---

\* vxianto@yahoo.com

this equation using non-linear field theory [2a][5][5a]. Barut's equation is as follows [5a]:

$$[i\gamma_\nu\partial_\nu - a\partial_\mu^2/m + \kappa] \Psi = 0 \quad (1)$$

where  $\partial_\nu = \partial/\partial x_\nu$  and repeated indices imply a summation [5a]. The remaining parameters come from substitution of variables:  $m = \kappa/\alpha_1$  and  $a/m = -\alpha_2/\alpha_1$  [5a]. In the meantime Barut-Dirac-Vigier's equation could be written as:

$$[c\alpha.p - E + \beta(mc^2 + \epsilon e^2/r)] \Psi = -[(\epsilon \hbar e^2)/(4\pi mc^2 r^2)]i\beta\alpha\Psi \quad (2)$$

Despite this apparently remarkable result of Barut's equation, nonetheless there is question concerning the physical meaning of his equation, in particular from the viewpoint of non-linear field theory [2a]. This question seems very interesting, in particular considering the unsolved question concerning the physical meaning of *wavefunction* in Quantum Mechanics [4a]. It is known that some proponents of 'realism' interpretation of Quantum Mechanics predict that there should be a complete 'realism' description of physical model of electron, where non-local hidden variables could be included [4][1a]. We consider that this question remains open for discussion, in particular in the context of plausible analog between classical electrodynamics and non-local quantum interference effect, via Aharonov-Casher effect [8].

In the present article we argue that it is possible to derive a new wave quantum relativistic equation as an alternative to Barut-Dirac-Vigier's equation. Our description is based on the known exact correspondence (isomorphism) between Dirac equation and Maxwell electromagnetic equations via biquaternionic representation. In fact, we will discuss five approaches as alternative to Barut-Dirac equation. And we would argue that the question of which of these approaches is the most consistent with experimental data remains open. Our proposition of alternative to Barut(-Dirac) equation was based on characteristics of Barut equation:

- it is a second-order differential equation (1);
- it shall include the physical meaning of vierbein in quantum mechanical equation;
- it has neat linkage with other known equations in Quantum Mechanics including Dirac equation [5a], while its solution could be different from Dirac approach [11];
- our observation asserts that it shall also include a proper introduction of Lorentz force, and acceleration from relativistic fluid dynamics.

Furthermore, in the present note we submit the viewpoint that it would be more conceivable if we interpret the *vierbein* of this equation in terms of superfluid velocity [12][13], which in turn brings us to the notion of topological electronic liquid [27]. Its implications to quantization of celestial systems lead us to argue in favor of signatures of Bose-Einstein cosmology, which thus far has not been explored sufficiently yet in the literature [49a][49b].

What we would argue in the present note is that one could expect to extend further this quaternion representation into the form of unified wave equation, in particular using Ulrych's representation [7]. While such an attempt to interpret *vierbein* of Dirac equation has been made by de Broglie (in terms of 'Dirac fluid' [41]), it seems that an

exact representation in terms of superfluid velocity has never been made before. From this viewpoint one could argue that the superfluid vierbein interpretation will make the picture resembles superfluid bivacuum model of Kaivarainen [20][21]. Furthermore, this proposition seems to support previous hypothetical argument by Prof. J-P. Vigi er on the further development of theoretical Quantum Mechanics [6]:

“..a revival, in modern *covariant form*, of the ether concept of the founding fathers of the theory of light (Maxwell, Lorentz, Einstein, *etc.*). This is a crucial question, and it now appears that the vacuum is a real physical medium, which presents surprising properties (superfluid, *i.e.* negligible resistance to inertial motions) . . . “

Provided this proposition of unified wave equation in terms of superfluid velocity *vierbein* corresponds to the observed facts, and then it could be used to predict some new observations, in particular in the context of condensed-matter analog of astrophysics [16][17][18]. Therefore in the last section we will extend this proposition to argue in favor of signatures of Bose-Einstein cosmology, including some recent relevant observation supporting this argument.

While quaternionic Quantum Mechanics has been studied before by Adler *etc.* [14c][28], and also biquaternionic Quantum Mechanics [2][3], it seems that interpreting the right-hand-side of the unified wave equation as superfluid 4-velocity has not been considered before, at least not yet in the context of cylindrical relativistic fluid of Carter and Sklarz-Horwitz.

In deriving these equations we will not rely on exactitude of the solutions, because as we shall see the known properties, like fine structure constant of hydrogen, can be derived from different approaches [11][15][19][22a]. Instead, we will use ‘correspondence between physical theories’ as a guiding principle, *i.e.* we argue that it is possible to derive some alternatives to Barut equation via generalization of various wave equations known in Quantum Mechanics. More linkage between these equations implies consistency.

Further experimental observation to verify or refute this proposition is recommended.

## 2. Biquaternion, Imaginary algebra, Unified relativistic Wave Equation

Before we discuss biquaternionic Maxwell equations from unified wave equation, first we should review Ulrych’s method [7] by defining imaginary number representation as follows [7]:

$$x = x_0 + j.x_1, \quad j^2 = -1 \quad (3)$$

This leads to the multiplication and addition (or subtraction) rules for any number, which is composed of real part and imaginary number:

$$(x \pm y) = (x_0 \pm y_0) + j.(x_1 \pm y_1), \quad (4)$$

$$(xy) = (x_0y_0 + x_1y_1) + j.(x_0y_1 + x_1y_0). \quad (5)$$

From these basic imaginary numbers, Ulrych [7] argues that it is possible to find a new *relativistic algebra*, which could be regarded as modified form of standard quaternion representation.

Once we define this imaginary number, it is possible to define further some relations as follows [14]. Given  $w = x_0 + j.x_1$ , then its D-conjugate of w could be written as:

$$\bar{w} = x_0 - j.x_1 \quad (6)$$

Also for any given two imaginary numbers  $w_1, w_2 \in D$ , we get the following relations [14]:

$$\overline{w_1 + w_2} = \bar{w}_1 + \bar{w}_2 \quad (7)$$

$$\overline{w_1 \bullet w_2} = \bar{w}_1 \bullet \bar{w}_2 \quad (8)$$

$$|w|^2 = \bar{w} \bullet w = x_0^2 - x_1^2 \quad (9)$$

$$|w_1 \bullet w_2|^2 = |w_1|^2 \bullet |w_2|^2 \quad (10)$$

All of these provide us nothing new. For extension of these imaginary numbers in Quantum Mechanics, see [33]. Now we will review a few elementary definitions of quaternions and biquaternions, which are proved to be useful.

It is known that biquaternions could describe Maxwell equations in its original form, and some of the use of biquaternions was discussed in [2][34].

Quaternion number, Q is defined by [33][60]:

$$Q = a + b.i + c.j + d.k \quad a, b, c, d \in R, \quad (11a)$$

where

$$i^2 = j^2 = k^2 = ijk = -1 \quad (11b)$$

Alternatively, one could extend this quaternion number to Clifford algebra [3a][3][6][25][41], because higher-dimensions Clifford algebra and analysis give the possibility to generalize the factorisations into higher spatial dimensions and even to space-time domains [70a]. In this regard quaternions  $H \sim Cl_{0,2}$ , while standard imaginary numbers  $C \sim Cl_{0,1}$  [70a].

Biquaternion is an extension of this quaternion number, and it is described here using Hodge-bracket operator, in lieu of known Hodge operator (\*\* = -1) [5a]:

$$\{Q\}^* = (a + iA) + (b + iB).i + (c + iC).j + (d + iD).k, \quad (12a)$$

where the second part (A,B,C,D) is normally set to zero in standard quaternions [33].

For quaternion differential operator, we define quaternion Nabla operator:

$$\nabla^q \equiv c^{-1}.\partial/\partial t + (\partial/\partial x)i + (\partial/\partial y)j + (\partial/\partial z)k = c^{-1}.\partial/\partial t + \vec{i}.\vec{\nabla} \quad (12b)$$

And for biquaternion differential operator, we define a quaternion Nabla-Hodge-bracket operator:

$$\{\nabla^q\}^* \equiv (c^{-1}.\partial/\partial t + c^{-1}.i\partial/\partial t) + \{\vec{\nabla}\}^* \quad (12c)$$

where Nabla-Hodge-bracket operator is defined as:

$$\{\vec{\nabla}\}^* \equiv (\partial/\partial x + i\partial/\partial X).i + (\partial/\partial y + i\partial/\partial Y).j + (\partial/\partial z + i\partial/\partial Z).k. \quad (13a)$$

It is worthnoting here that equations (4)-(10) are also applicable for biquaternion number. While equations (3)-(12a) are known in the existing literature [33][59], and sometimes called ‘biparavector’ (Baylis), we prefer to call it ‘imaginary algebra’ with emphasis on the use of Hodge-bracket operator. It is known that determinant and differentiation of quaternionic equations are different from standard differential equations [59], therefore solution for this problem has only been developed in recent years.

The Hodge-bracket operator proposed herein could become more useful if we introduce quaternion number (11a) in the paravector form [70]:

$$\vec{q} = \sum_{k=0}^3 q_k \cdot e_k \text{ when } \{q_k\} \subset C, \{e_k | k = 1, 2, 3\} \quad (13b)$$

and  $e_0$  is the unit. Therefore, biquaternion number could be written in the same form [70]:

$$\{\vec{q}\}^* = \vec{q} + i\vec{q} = \sum_{k=0}^3 q_k \cdot e_k + i\left\{\sum_{k=0}^3 q_k \cdot e_k\right\} \quad (13c)$$

Now we are ready to discuss Ulrych’s method to describe unified wave equation [7], which argues that it is possible to define a unified wave equation in the form [7]:

$$D\phi(x) = m_\phi^2 \cdot \phi(x), \quad (14)$$

where unified (wave) differential operator D is defined as:

$$D = \left[ (P - qA)_\mu (\bar{P} - qA)^\mu \right]. \quad (15)$$

To derive Maxwell equations from this unified wave equation, he uses free photon fields expression [7]:

$$DA(x) = 0, \quad (16)$$

where potential A(x) is given by:

$$A(x) = A^0(x) + jA^1(x), \quad (17)$$

and with electromagnetic fields:

$$E^i(x) = -\partial^0 A^i(x) - \partial^i A^0(x), \quad (18)$$

$$B^i(x) = \epsilon^{ijk} \partial_j A_k(x). \quad (19)$$

Inserting these equations (17)-(19) into (16), one finds Maxwell electromagnetic equation [7]:

$$\begin{aligned} & -\nabla \bullet E(x) - \partial^0 C(x) \\ & + ij\nabla \bullet B(x) \\ & -j(\nabla x B(x) - \partial^0 E(x) - \nabla C(x)) \\ & -i(\nabla x E(x) + \partial^0 B(x)) = 0 \end{aligned} \quad (20)$$

The gauge transformation of the vector potential  $A(x)$  is given by [7]:

$$A'(x) = A(x) + \nabla\Lambda(x)/e, \quad (21)$$

where  $\Lambda(x)$  is a scalar field. As equations (17)-(18) only use simple definitions of imaginary numbers (3)-(5), then an extension from (20) and (21) to biquaternionic form of Maxwell equations is possible [2][34].

In order to define biquaternionic representation of Maxwell equations, we could extend Ulrych's definition of *unified differential operator* [7] to its biquaternion counterpart, by using equation (12a), to become:

$$\{D\}^* \equiv \left[ (\{P\} * -q\{A\}^*)_\mu (\{\bar{P}\} * -q\{A\}^*)^\mu \right], \quad (22a)$$

or by definition  $P = -i\hbar\nabla$  and (13a), equation (22a) could be written as:

$$\{D\}^* \equiv \left[ (-\hbar\{\nabla\} * -q\{A\}^*)_\mu (-\hbar\{\nabla\} * -q\{A\}^*)^\mu \right], \quad (22b)$$

where each component is now defined in its biquaternionic representation. Therefore the biquaternionic form of unified wave equation takes the form:

$$\{D\} * \phi(x) = m_\phi^2 \cdot \phi(x), \quad (23)$$

if we assume the wavefunction is not biquaternionic, and

$$\{D\} * \{\phi(x)\}^* = m_\phi^2 \cdot \{\phi(x)\}^* . \quad (24)$$

if we suppose that the wavefunction also takes the same biquaternionic form.

Now, biquaternionic representation of free photon fields could be written in the same way with (16), as follows:

$$\{D\} * A(x) = 0 \quad (25)$$

We will not explore here complete solution of this biquaternion equation, as it has been discussed in various literatures aforementioned above, including [2][33][34][59]. However, immediate implications of this biquaternion form of Ulrych's unified equation can be described as follows.

Ulrych's fermion wave equation in the presence of electromagnetic field reads [7]:

$$\left[ (P - qA)_\mu (\bar{P} - qA)^\mu \psi \right] = -m^2 \cdot \psi, \quad (26)$$

which asserts  $c=1$  (conventionally used to write wave equations). In accordance with Ulrych [7] this equation implies that the differential operator of the quantum wave equation (LHS) is composed of the momentum operator  $P$  multiplied by its dual operator, and taking into consideration electromagnetic field effect  $qA$ . And by using definition of momentum operator:

$$P = -i\hbar\nabla. \quad (27)$$



So we get three-dimensional relativistic wave equation [7]:

$$[(-i\hbar\nabla_\mu - qA_\mu)(-i\hbar\nabla^\mu - qA^\mu)\psi] = -m^2.c^2.\psi. \quad (28)$$

which is Klein-Gordon equation. Its 1-dimensional version has also been derived by Nottale [67, p,29]. A plausible extension of equation (28) using biquaternion differential operator defined above (22a) yields:

$$[(-\hbar\{\nabla_\mu\} * -q\{A_\mu\}*)(-\hbar\{\nabla^\mu\} * -q\{A^\mu\}*)\psi] = -m^2.c^2.\psi, \quad (29)$$

which could be called as ‘biquaternionic’ Klein-Gordon equation.

Therefore we conclude that there is neat correspondence between Ulrych’s fermion wave equation and Klein Gordon equation, in particular via biquaternionic representation. It is also worthnoting that it could be shown that Schrodinger equation could be derived from Klein-Gordon equation [11], and Klein-Gordon equation also neatly corresponds to Duffin-Kemmer-Petiau equation. Furthermore it could be proved that modified (quaternion) Klein-Gordon equation could be related to Dirac equation [7]. All of these linkages seem to support argument by Gursey and Hestenes who find plenty of interesting features using quaternionic Dirac equation. In this regard, Meessen has proposed a method to describe elementary particle from Klein-Gordon equation [30].

By assigning imaginary numbers to each component [7, p.26], equation (26) could be rewritten as follows (by writing  $c=1$ ):

$$\left[(P - qA)_\mu (P - qA)^\mu - eE^i{}_{ij}\sigma_i - eB^i\sigma_i + m^2\right]\psi = 0, \quad (30)$$

where Pauli matrices  $\sigma_i$  are written explicitly. Now it is possible to rewrite equation (30) in complete tensor formalism [7], if Pauli matrices and electromagnetic fields are expressed with antisymmetric tensor, so we get:

$$\left[(P - qA)_\mu (\bar{P} - qA)^\mu - e\sigma_{\mu\nu}F^{\mu\nu} + m^2\right]\psi = 0, \quad (31)$$

where

$$F_{\mu\nu} = (\partial_\mu A_\nu - \partial_\nu A_\mu). \quad (32)$$

Note that equation (31) is formal identical to *quadratic form* of Dirac equation [7], which supports argument suggesting that modified (quaternion) Klein-Gordon equation could be related to Dirac equation. Interestingly, equation (31) is also known in the literature as Feynman-Gell-Mann’s equation, and its implications will be discussed in subsequent section [5]. Interestingly, if we neglect contribution of the electromagnetic field ( $q$  and  $e$ ) component, and using only 1-dimensional of the partial differentiation, one gets a wave equation from Feynman rules [56, p.6]:

$$(\partial_\mu\partial^\mu + m^2)\Psi = 0, \quad (33)$$

which has been used to describe quantum-electrodynamics without renormalization [56].

Further extension of equation (28) could be made by expressing it in terms of 4-velocity:

$$[(-i\hbar\nabla_\mu - qA_\mu)(-i\hbar\nabla^\mu - qA^\mu)\psi] = -p_\mu p^\mu \cdot \psi. \quad (34)$$

In the context of relativistic fluid [10][11], one could argue that this 4-velocity corresponds to superfluid vierbein [13][16][17]. Therefore we could use Carter-Langlois' equation [12]:

$$\mu_\rho \cdot \mu^\rho = -c^2 \cdot \mu^2, \quad (35)$$

by replacing  $m$  with the effective mass variable  $\mu$ . This equation has the meaning of cylindrically symmetric superfluid with known metric [12]:

$$g_{\rho\sigma} \cdot dx^\rho \cdot dx^\sigma = -c^2 \cdot dt^2 + dz^2 + r^2 \cdot d\phi^2 + dr^2. \quad (36)$$

Further extension of equation (35) is possible, as discussed by Fischer [13], where the effective mass variable term also appears in the LHS of velocity equation, by defining momentum of the continuum as:

$$p_\alpha = \mu \cdot u_\alpha. \quad (37)$$

Therefore equation (35) now becomes:

$$\mu^2 \cdot u_\alpha \cdot u^\alpha = -c^2 \cdot \mu^2, \quad (38)$$

where the effective mass variable now acquires the meaning of chemical potential [13]:

$$\mu = \partial \epsilon / \partial \rho, \quad (39)$$

and

$$\rho \cdot p_\alpha / \mu = (K/\hbar^2) p_\alpha = j_\alpha, \quad (40)$$

$$K = \hbar^2 (\rho/\mu). \quad (41a)$$

The quantity  $K$  is defined as the stiffness coefficient against variations of the order parameter phase. Alternatively, from macroscopic dynamics of Bose-Einstein condensate containing vortex lattice, one could write the chemical potential in the form [57]:

$$\mu = \mu_0 \cdot [1 - (\Omega_0/\omega_\perp)^2]^{2/5} \quad (41b)$$

where the quantity  $\Omega$  corresponds to the angular frequency of the sample and is assumed to be uniform,  $\omega$  is the oscillator frequency, and chemical potential in the absence of rotation is given by [57]:

$$\mu_0 = (\hbar\omega_{ho}/2) (Na/0.0667a_{ho})^{2/5} \quad (41c)$$

and  $N$  represents the number of atoms and  $a$  is the corresponding oscillator length [57]:

$$a_{ho} = \sqrt{\hbar/M\omega_{ho}} \quad (41d)$$

Now the sound speed  $c_s$  could be related to the equations above, for a barotropic fluid [13], as:

$$c_s = d(\ln \mu) / d(\ln \rho) = (K/\hbar^2) d^2 \in /d\rho^2. \quad (42)$$

Using this definition, then equation (42) could be rewritten as follows:

$$p_\alpha = (K^{-1}\hbar^2) j_\alpha = (j_\alpha/c_s).d^2 \in /d\rho^2, \quad (43)$$

Introducing this result (43) into equation (34), we get:

$$[(-i\hbar\nabla_\mu - qA_\mu)(-i\hbar\nabla^\mu - qA^\mu)\psi] = -((j_\alpha/c_s).d^2 \in /d\rho^2)^2.\psi \quad (44)$$

which is an alternative expression of relativistic wavefunction in terms of superfluid sound speed,  $c_s$ . Note that this equation could appear only if we interpret 4-velocity in terms of *superfluid vierbein* [11][12]. Therefore this equation is Klein-Gordon equation, where vierbein is defined in terms of superfluid velocity. Alternatively, in condition without electromagnetic charge, then we can rewrite equation (44) in the known form of standard Klein-Gordon equation [36]:

$$[D_\mu D^\mu \psi] = -((j_\alpha/c_s).d^2 \in /d\rho^2)^2.\psi. \quad (45)$$

Therefore, this alternative representation of Klein-Gordon equation (45) has the physical meaning of relativistic wave equation for superfluid phonon [37][38].

A plausible extension of (44) is also possible using our definition of biquaternionic differential operator (22a):

$$\boxed{\{D\} * \psi = -((j_\alpha/c_s).d^2 \in /d\rho^2)^2 \psi} \quad (46)$$

which is an alternative expression from Ulrych's [7] unified relativistic wave equation, where the vierbein is defined in terms of superfluid sound speed,  $c_s$ . This is the main result of this section. As alternative, equation (46) could be written in compact form:

$$[\{D\} * +\Gamma]\Psi = 0, \quad (47)$$

where the operator  $\Gamma$  is defined according to the quadratic of equation (43):

$$\Gamma = ((j_\alpha/c_s).d^2 \in /d\rho^2)^2. \quad (48a)$$

For the solution of equation (44)-(47), one could refer for instance to alternative description of quarks and leptons via SU(4) symmetry [28][58]. As we note above, equation (31) is also known in the literature as Feynman-Gell-Mann's equation, and it has been argued that it has neat linkage with Barut equation [5]. This assertion could be made more conceivable by noting that equation (31) is quadratic form of Dirac equation. In this regard, recently Kruglov has considered a plausible generalization of Barut equation via third-order differential extension of Dirac equation [60]:

$$(\gamma_\mu \partial_\mu + m_1)(\gamma_\nu \partial_\nu + m_2)(\gamma_\alpha \partial_\alpha + m_3)\psi = 0. \quad (48b)$$

It is also interesting to note that in his previous work, Kruglov [60a] has argued in favor of Dirac-Kahler equation:

$$(d - \delta + m) \psi = 0, \quad (48c)$$

where the operator  $(d - \delta)$  is the analog of Dirac operator  $\gamma_\mu \partial^\mu$ . It seems plausible, therefore, in the context of Kruglov's recent attempt to generalize Barut equation [60] to argue that further generalization to biquaternionic form is possible by rewriting equation (47) in the third-order equation, by using our definition (12c):

$$[\{\vec{\nabla}_\mu^q\} * + p_\mu][\{\vec{\nabla}_\nu^q\} * + p_\nu][\{\vec{\nabla}_\alpha^q\} * + p_\alpha] \Psi = 0. \quad (48d)$$

Therefore, we could consider this equation as the first alternative to (generalized) Barut equation. Note that we use here equation (12c) instead of (22a), in accordance with Kruglov [60] definition:

$$\partial_\nu = \partial / \partial x_\nu = (\partial / \partial x_m, \partial / \partial(it)) \quad (48e)$$

In subsequent sections, we will consider a number of other plausible alternatives to Barut-Dirac's equation, in particular from the viewpoint of superfluid vierbein.

### 3. Alternative #2: Barut-Dirac-Feynman-Gell-Mann Equation

It is argued [5, p. 4] that Barut equation is the sum of Dirac equation and Feynman-Gell-Mann's equation (31). But from the aforementioned argument, it should be clear that the Feynman-Gell-Mann's equation is nothing more than Ulyrch's fermion wave equation, which is indeed a quadratic of Dirac equation. Therefore, it seems that there should be other route to derive Barut-Dirac type equation. In this regard, we submit the viewpoint that the introduction of electron self-field would lead to an alternative of Barut equation.

First, let us rewrite equation (31) with assigning the real  $c$  in lieu of  $c=1$ :

$$\left[ (P - qA)_\mu (\bar{P} - qA)^\mu - e\sigma_{\mu\nu} F^{\mu\nu} + m^2 c^2 \right] \psi = 0, \quad (49)$$

By using equation (34), then Feynman-Gell-Mann's equation becomes:

$$\left[ (-i\hbar\nabla_\mu - qA_\mu) (-i\hbar\nabla^\mu - qA^\mu) - e\sigma_{\mu\nu} F^{\mu\nu} + p_\mu p^\mu \right] \Psi = 0, \quad (50)$$

or

$$\left[ (-i\hbar\nabla_\mu - qA_\mu) (-i\hbar\nabla^\mu - qA^\mu) + p_\mu p^\mu \right] \Psi = (e\sigma_{\mu\nu} F^{\mu\nu}) \Psi, \quad (51)$$

which can be called Feynman-Gell-Mann's equation with superfluid vierbein interpretation, in particular if we then introduce equation (43) into the LHS.

In this regard, we can introduce Ibison's description of electron self-energy from ZPE [38]:

$$e\sigma_{\mu\nu} F^{\mu\nu} = m_0 a^\mu - m_0 \tau_0 \left[ da^\lambda / d\tau + a^\lambda a_\lambda u^\mu / c^2 \right] \quad (52)$$

where

$$\tau_0 = e^2 / 6\pi\epsilon_0 m_0 c^3 \quad (53)$$

The first term in the right hand side of equation (52) could be written in the Lorentz form [42] [24a, p.12]:

$$m_0 a^\mu = m[dv/dt] = e[E + vxB] \quad (54)$$

where:

$$E = -\nabla\phi, \quad (55)$$

$$B = \nabla x A. \quad (56)$$

Therefore, by defining a new parameter [24a, p.12]:

$$\forall = e[E + vxB]^\mu - m_0(e^2/6\pi\epsilon_0 m_0 c^3) [da^\lambda/d\tau + a^\lambda a_\lambda u^\mu/c^2], \quad (57)$$

one could rewrite equation (51) in term of equation (43):

$$\left[ (-i\hbar\nabla_\mu - qA_\mu) (-i\hbar\nabla^\mu - qA^\mu) + ((j_\alpha/c_s).d^2 \in /d\rho^2)^2 \right] \Psi = \forall\Psi, \quad (58)$$

which could be regarded as a second alternative expression of Barut equation. Therefore we propose to call it Barut-Dirac-Feynman-Gell-Mann equation. Implications of this equation should be verified via experiments, in particular with condensed-matter physics.

#### 4. Alternative #3: Second Order Differential Form of Schrödinger-Type Equation

It is known that Barut equation is a typical second-order differential equation, which is therefore non-linear. Therefore a good alternative to Barut equation could be derived from similar approach with Schrödinger's original equation, but this time it should be differentiated twice.

In this regard, it seems worthnoting here that it is more proper to use Noether's expression of total energy in lieu of standard derivation of Schrödinger's equation ( $E = \vec{p}^2/2m$ ). According to Noether's theorem [39], the total energy of the system corresponding to the time translation invariance is given by:

$$E = mc^2 + (cw/2). \int_0^\infty (\gamma^2.4\pi r^2.dr) = k\mu c^2 \quad (59)$$

where  $k$  is *dimensionless* function. It could be shown, that for low-energy state the total energy could be far less than  $E = mc^2$ . Interestingly Bakhoun [22] has also argued in favor of using  $E = mv^2$  for expression of total energy, which expression could be traced back to Leibniz. Therefore it seems possible to argue that expression  $E = mv^2$  is more generalized than the standard expression of special relativity, in particular because the total energy now depends on actual velocity [39].

From this new expression, it is plausible to rederive quantum relativistic wave equation in second-order differential expression, and it turns out the new equation should also include a Lorentz-force term in the same way of equation (57). This feature is seemingly interesting, because these equations are derived from different approach from (57).

We start with Bakhoum's assertion that it is more appropriate to use  $E = mv^2$ , instead of more convenient form  $E = mc^2$ . This assertion would imply [22]:

$$H^2 = p^2 \cdot c^2 - m_o^2 \cdot c^2 \cdot v^2. \quad (60)$$

Therefore, for phonon speed ( $c_s$ ) in the limit  $p \rightarrow 0$ , we write [37]:

$$E(p) \equiv c_s \cdot |p|. \quad (61)$$

A bit remark concerning Bakhoum's expression, it does not mean to imply or to interpret  $E = mv^2$  as an assertion that it implies zero energy for a rest mass. Actually the problem comes from 'mixed' interpretation of what we mean with 'velocity'. In original Einstein's paper (1905) it is defined as 'kinetic velocity', which can be measured when standard 'steel rod' has velocity approximates the speed of light. But in quantum mechanics, we are accustomed to make use it deliberately to express 'photon speed'=c. According to Bakhoum, to get a consistent interpretation between special relativity and quantum mechanics, we should treat this definition of velocity according to its context, in particular to its linkage with electromagnetic field. Therefore, in special relativity 1905 paper, it should be better to interpret it as 'speed of free electron', which approximates c. For muon, Spohn [42] has obtained  $v=0.9997c$  which is very near to c, but not exactly =c. For hydrogen atom with 1 electron, the electron occupies the first excitation (quantum number  $n=1$ ), which implies that their speed also approximate c, which then it is quite safe to assume  $E \sim mc^2$ . But for atoms with large amount of electrons occupying large quantum numbers, as Bakhoum showed that electron speed could be far less than c, therefore it will be more exact to use  $E = mv^2$ , where here v should be defined as 'average electron speed'. Furthermore, in the context of relativistic fluid, we could use  $E_\alpha = \mu \cdot u_\alpha u_\alpha$  from equation (37).

In the first approximation of relativistic wave equation, we could derive Klein-Gordon-type relativistic equation from equation (60), as follows. By introducing a new parameter:

$$\zeta = i(v/c), \quad (62)$$

then we can rewrite equation (60) in the known procedure of Klein-Gordon equation:

$$E^2 = p^2 \cdot c^2 + \zeta^2 m_o^2 \cdot c^4, \quad (63)$$

where  $E = mv^2$ . [22] By using known substitution:

$$E = i\hbar \cdot \partial/\partial t, \quad p = \hbar \nabla/i, \quad (64)$$

and dividing by  $(\hbar c)^2$ , we get Klein-Gordon-type relativistic equation:

$$-c^{-2} \partial \Psi / \partial t + \nabla^2 \Psi = k_o'^2 \Psi, \quad (65)$$

where

$$k_o' = \zeta m_o c / \hbar. \quad (66)$$

One could derive Dirac-type equation using similar method. But the use of new parameter (62) seems to be indirect, albeit it simplifies the solution because here we can use the same solution from Klein-Gordon equation [30].

Alternatively, one could derive a new quantum relativistic equation, by noting that expression of total energy  $E = mv^2$  is already relativistic equation. We will derive here two approaches to get relativistic wave equation from this expression of total energy.

The first approach, is using Ulrych's [7] method as follows:

$$E = mv^2 = p.v \quad (67)$$

Taking square of this expression, we get:

$$E^2 = p^2.v^2 \quad (68)$$

or

$$p^2 = E^2/v^2 \quad (69)$$

Now we use Ulrych's substitution [7]:

$$\left[ (P - qA)_\mu (\bar{P} - qA)^\mu \right] = p^2, \quad (70)$$

and introducing standard substitution in Quantum Mechanics (64), one gets:

$$\left[ (P - qA)_\mu (\bar{P} - qA)^\mu \right] \Psi = v^{-2} \cdot (i\hbar \cdot \partial/\partial t)^2 \Psi, \quad (71)$$

or

$$\left[ (-i\hbar \nabla_\mu - qA_\mu) (-i\hbar \nabla^\mu - qA^\mu) - (i\hbar/v \cdot \partial/\partial t)^2 \right] \Psi = 0. \quad (72a)$$

which can be called as Noether-Ulrych-Feynman-Gell-Mann's (NUFG) equation. This is the third alternative to Barut-Dirac equation.

Alternatively, by using standard definition  $p=m.v$ , we can rewrite equation (71) in form of equation (43):

$$\left[ (P - qA)_\mu (\bar{P} - qA)^\mu \right] \Psi = m^2 \left( (j_\alpha/c_s) \cdot d^2 \in /d\rho^2 \right)^{-2} \cdot (i\hbar \cdot \partial/\partial t)^2 \Psi. \quad (72b)$$

In order to verify that we can use the same method with Schrödinger equation to derive nonlinear wave equation, let us consider Oleinik's nonlinear wave equation. It is argued that the proper equation of motion is not the Dirac or Schrödinger equation, but an equation with a new self-energy term [24]. This would mean that there is a pair wavefunction to include electron interaction with its surrounding medium. Therefore, the standard Schrödinger equation becomes nonlinear equations of motion [24]:

$$\left[ i\partial/\partial t + \bar{\nabla}^2/2m - U(x) \right] \begin{pmatrix} \Psi(x) \\ \bar{\Psi}(x) \end{pmatrix} = 0 \quad (73)$$

where we use  $\hbar = 1$  for convenience.

From this equation, one can get the relativistic version corresponding to Dirac equation [24]. Interestingly, Froelich [66] has considered equation of motion for the few-body

systems associated with the hydrogen-antihydrogen pairs using radial Schrödinger-type equation. Therefore, it seems interesting to consider equation (73) also in the context of hydrogen-antihydrogen molecule.

And because equation (73) is derived from the standard definition of total energy  $E = \vec{p}^2/2m$ , then our method to use equation (60) seems to be a logical extension of Oleinik's method. To get nonlinear version similar to equation (73), then we could rewrite equation (72a) as:

$$\left[(-i\hbar\nabla_\mu - qA_\mu)(-i\hbar\nabla^\mu - qA^\mu) - (i\hbar/v.\partial/\partial t)^2\right] \begin{pmatrix} \Psi(x) \\ \bar{\Psi}(x) \end{pmatrix} = 0. \quad (74)$$

What's more interesting here, is that Oleinik [24a, p.12] has shown that equation (73) could lead to an expression of Newtonian-Lorentz force similar to equation (54):

$$m_0 a^\mu = m[d^2 r/dt^2] = e[E + v \times B] \quad (75)$$

This verifies our aforementioned proposition that a good alternative to Barut's equation should include a Lorentz-force term in wave equation. In other words, from equation (73) we find neat linkage between Schrödinger equation, nonlinear wave, and Lorentz-force. We will use this linkage in the following section. It turns out that we can find a proper generalization of Barut's equation via introduction of Newtonian-acceleration from velocity of the relativistic fluid in similar form of Lorentz force.

## 5. Alternative #4: Lorentz-force & Newtonian Acceleration Method

For the fourth method, we will introduce Leibniz rule [40] into equation (67) via differentiation with respect to time, which yields:

$$dE/dt = d[p.v]/dt = v.[dp/dt] + p.[dv/dt] \quad (76)$$

The next step is taking derivation of the known substitution in QM:

$$dE/dt = i\hbar.\partial^2/\partial t^2, \quad (77)$$

$$dp/dt = d(-i\hbar\nabla)/dt = -i\hbar\dot{\nabla}$$

Now, substituting back equation (77) and (64) into equation (76), we get:

$$(i\hbar.\partial^2/\partial t^2)\Psi = (v.[-i\hbar\dot{\nabla}] - [dv/dt].i\hbar\nabla)\Psi. \quad (78)$$

At this point, we note that the second term in the right hand side of equation (78) could be written in the Lorentz force form [42], and following equation (54):

$$[dv/dt] = e/m.(E + vxB) \quad (79)$$

where:

$$E = -\nabla\phi, \quad (80)$$



$$B = \nabla x A. \quad (81)$$

Therefore, we can rewrite equation (78) in the form:

$$(i\hbar.\partial^2/\partial t^2)\Psi = (v.[-i\hbar\dot{\nabla}] - e/m.[E + vxB].i\hbar\nabla)\Psi, \quad (82)$$

which is a new wave relativistic quantum equation as alternative to Barut equation. To our present knowledge, this alternative wave equation (82) has never been derived elsewhere.

As an alternative to equation (79), we can rewrite Lorentz form in term of Newtonian acceleration. In this regard, it is worthnoting that the definition of acceleration of relativistic fluid is not widely accepted yet [10]. Therefore we will use here result from relativistic field equations from Poisson process [46], from which we get an expression of acceleration [46]:

$$dv/dt = \hbar/2m.(\partial^2 u/\partial x^2) - v.\partial u/\partial x + u.\partial v/\partial x - m^{-1}.\partial V/\partial x = \exists \quad (83)$$

Therefore, by substituting this equation into (78), we get:

$$(i\hbar.\partial^2/\partial t^2)\Psi = (v.[-i\hbar\dot{\nabla}] - \exists.i\hbar\nabla)\Psi, \quad (84)$$

which can be considered as a better alternative to equation (82).

## 6. Alternative #5: Schrödinger-Ginzburg-Landau Equation and Quantization of Celestial Systems

In the preceding section (#4), we have found the neat linkage between Schrödinger equation, nonlinear wave, and Lorentz-force, which indicates a possibility to be considered as alternative to Barut equation. Now, as the fifth alternative method, it will be shown that we can expect to generalize Schrödinger equation to describe quantization of celestial systems. While this notion of macro-quantization is not widely accepted yet, as we will see the logarithmic nature of Schrödinger equation is sufficient to ensure its applicability to larger systems. As alternative, we will also discuss an outline for deriving Schrödinger equation from simplification of Ginzburg-Landau equation. It is known that Ginzburg-Landau equation exhibits fractal character.

First, let us rewrite Schrödinger equation (73) in its common form:

$$[i\partial/\partial t + \bar{\nabla}^2/2m - U(x)] \Psi = 0 \quad (85)$$

where we use  $\hbar = 1$  for convenience, or

$$(i\partial/\partial t)\Psi = H.\Psi \quad (86)$$

Now, it is worthnoting here that Englman & Yahalom [4a] argue that this equation exhibits logarithmic character:

$$\ln \Psi(x, t) = \ln (|\Psi(x, t)|) + i. \arg(\Psi(x, t)) \quad (87)$$

Schrödinger already knew this expression in 1926, which then he used it to propose his equation called ‘*eigentliche Wellengleichung*’ [4a]. Therefore equation (85) can be rewritten as follows:

$$2m(\partial \ln |\Psi| / \partial t) + 2\bar{\nabla} \ln |\Psi| \cdot \bar{\nabla} \arg[\Psi] + \bar{\nabla} \cdot \bar{\nabla} \arg[\Psi] = 0 \quad (88)$$

Interestingly, Nottale’s scale-relativistic method [43][44] was also based on generalization of Schrödinger equation to describe quantization of celestial systems. It is known that Nottale-Schumacher’s method [45] could predict new exoplanets in good agreement with observed data. Nottale’s scale-relativistic method is essentially based on the use of first-order scale-differentiation method defined as follows [43][44]:

$$\partial V / \partial (\ln \delta t) = \beta(V) = a + bV + \dots \quad (89)$$

Now it seems clear that the logarithmic derivation, which is essential in scale-relativity approach, also has been described properly in Schrödinger’s original equation [4a]. In other word, its logarithmic form ensures applicability of Schrödinger equation to describe macroquantization of celestial systems.

To emphasize this assertion of the possibility to describe quantization of celestial systems, let us return for a while to the preceding section where we use Fischer’ description [13] of relativistic momentum of 4-velocity (37)-(38). Interestingly Fischer [13] argues that the circulation leading to equation (37)-(38) is in the relativistic dense superfluid, defined as the integral of the momentum:

$$\gamma_s = \oint p_\mu dx^\mu = 2\pi \cdot N_v \hbar, \quad (90)$$

and is quantized into multiples of Planck’s quantum of action. This equation is the covariant Bohr-Sommerfeld quantization of  $\gamma_s$ . And then Fischer [13] concludes that the *Maxwell equations of ordinary electromagnetism can be cast into the form of conservation equations of relativistic perfect fluid hydrodynamics* [10], in good agreement with Vigier’s guess as mentioned above. Furthermore, the topological character of equation (90) corresponds to the notion of topological electronic liquid, where compressible electronic liquid represents superfluidity [27].

It is worthnoting here, because here vortices are defined as elementary objects in the form of stable topological excitations [13], then equation (90) could be interpreted as signatures of Bohr-Sommerfeld quantization from topological quantized vortices. Fischer [13] also remarks that equation (90) is quite interesting for the study of superfluid rotation in the context of gravitation. Interestingly, application of Bohr-Sommerfeld quantization to celestial systems is known in literature [47][48], which here in the context of Fischer’s arguments it seems plausible to suggest that quantization of celestial systems actually corresponds to superfluid-quantized vortices at large-scale [27]. In our opinion, this result supports known experiments suggesting neat correspondence between condensed matter physics and various cosmology phenomena [16]-[19].

To make the conclusion that quantization of celestial systems actually corresponds to superfluid-quantized vortices at large-scale a bit conceivable, let us consider an illustration of quantization of celestial orbit in solar system.

In order to obtain planetary orbit prediction from this hypothesis we could begin with the Bohr-Sommerfeld's conjecture of quantization of angular momentum. This conjecture may originate from the fact that according to BCS theory, superconductivity can exhibit macroquantum phenomena [16][65]. In principle, this hypothesis starts with observation that in quantum fluid systems like superfluidity, it is known that such vortexes are subject to quantization condition of integer multiples of  $2\pi$ , or  $\oint v_s \cdot dl = 2\pi \cdot n\hbar/m_4$ . As we know, for the wavefunction to be well defined and unique, the momenta must satisfy Bohr-Sommerfeld's quantization condition:

$$\oint_{\Gamma} p \cdot dx = 2\pi \cdot n\hbar \quad (91)$$

for any closed classical orbit  $\Gamma$ . For the free particle of unit mass on the unit sphere the left-hand side is [49]:

$$\int_0^T v^2 \cdot d\tau = \omega^2 \cdot T = 2\pi \cdot \omega \quad (92)$$

where  $T=2\pi/\omega$  is the period of the orbit. Hence the quantization rule amounts to quantization of the rotation frequency (the angular momentum):  $\omega = n\hbar$ . Then we can write the force balance relation of Newton's equation of motion [49]:

$$GMm/r^2 = mv^2/r \quad (93)$$

Using Bohr-Sommerfeld's hypothesis of quantization of angular momentum, a new constant  $g$  was introduced:

$$mvr = ng/2\pi \quad (94)$$

Just like in the elementary Bohr theory (before Schrödinger), this pair of equations yields a known simple solution for the orbit radius for any quantum number of the form [49]:

$$r = n^2 \cdot g^2 / (4\pi^2 \cdot GM \cdot m^2) \quad (95)$$

which can be rewritten in the known form [43][44]:

$$r = n^2 \cdot GM / v_o^2 \quad (96)$$

where  $r$ ,  $n$ ,  $G$ ,  $M$ ,  $v_o$  represents orbit radii, quantum number ( $n=1,2,3,\dots$ ), Newton gravitation constant, and mass of the nucleus of orbit, and specific velocity, respectively. In this equation (96), we denote:

$$v_o = (2\pi/g) \cdot GMm \quad (97)$$

The value of  $m$  is an adjustable parameter (similar to  $g$ ). [43][44]

Using this equation (96), we could predict quantization of celestial orbits in the solar system, where for Jovian planets we use least-square method and define  $M$  in terms of reduced mass  $\mu = (M_1.M_2)/(M_1 + M_2)$ . From this viewpoint the result is shown in Table 1 below [49]:

Table 1. Comparison of prediction and observed orbit distance of planets in Solar system (in 0.1 AU unit) [49]

Object	No.	Bode	Nottale	CSV	Observed	$\Delta(\%)$
	1		0.4	0.428		
	2		1.7	1.71		
Mercury	3	4	3.9	3.85	3.87	0.52
Venus	4	7	6.8	6.84	7.32	6.50
Earth	5	10	10.7	10.70	10.00	-6.95
Mars	6	16	15.4	15.4	15.24	-1.05
Hungarias	7		21.0	20.96	20.99	0.14
Asteroid	8		27.4	27.38	27.0	1.40
Camilla	9		34.7	34.6	31.5	-10.00
Object	No.	Bode	Nottale	CSV	Observed	$\Delta(\%)$
Jupiter	2	52		45.52	52.03	12.51
Saturn	3	100		102.4	95.39	-7.38
Uranus	4	196		182.1	191.9	5.11
Neptune	5			284.5	301	5.48
Pluto	6	388		409.7	395	-3.72
2003EL61	7			557.7	520	-7.24
Sedna	8	722		728.4	760	4.16
2003UB31	9			921.8	970	4.96
Unobserved	10			1138.1		
Unobserved	11			1377.1		

For comparison purpose, we also include some recent observation by M. Brown *et al.* from Caltech [50][51][52][53]. It is known that Brown *et al.* have reported not less than four new planetoids in the outer side of Pluto orbit, including 2003EL61 (at 52AU), 2005FY9 (at 52AU), 2003VB12 (at 76AU, dubbed as *Sedna.*) And recently Brown and his team reported a new planetoid finding, called 2003UB31 (97AU). This is not to include *Quaoar* (42AU), which has orbit distance more or less near Pluto (39.5AU), therefore this object is excluded from our discussion. It is interesting to remark here that all of those

new ‘planetoids’ are within 8% bound from our prediction of celestial quantization based on the above Bohr-Sommerfeld quantization hypothesis (Table 1). While this prediction is not so precise compared to the observed data, one could argue that the 8% bound limit also corresponds to the remaining planets, including inner planets. Therefore this 8% uncertainty could be attributed to macroquantum uncertainty and other local factors.

While our previous prediction only limits new planet finding until  $n=9$  of Jovian planets (outer solar system), it seems that there are enough reasons to suppose that more planetoids are to be found in the near future. Therefore it is recommended to extend further the same quantization method to larger  $n$  values. For prediction purpose, we include in Table 1 new expected orbits based on the same quantization procedure we outlined before. For Jovian planets corresponding to quantum number  $n=10$  and  $n=11$ , our method suggests that it is likely to find new orbits around 113.81 AU and 137.71 AU, respectively. It is recommended therefore, to find new planetoids around these predicted orbits.

As an interesting alternative method supporting this proposition of quantization from superfluid-quantized vortices (90), it is worthnoting here that Kiehn has argued in favor of re-interpreting the square of the wavefunction of Schrödinger equation as the vorticity distribution (including topological vorticity defects) in the fluid [61]. From this viewpoint, Kiehn suggests that there is *exact mapping* from Schrödinger equation to Navier-Stokes equation, using the notion of quantum vorticity [61]. Interestingly, de Andrade & Sivaram [62] also suggest that there exists formal analogy between Schrödinger equation and the Navier-Stokes viscous dissipation equation:

$$\partial V/\partial t = \nu.\nabla^2 V \quad (98)$$

where  $\nu$  is the kinematic viscosity. Their argument was based on propagation torsion model for quantized vortices [62]. While Kiehn’s argument was intended for ordinary fluid, nonetheless the neat linkage between Navier-Stokes equation and superfluid turbulence is known in literature [63][64][21].

Therefore, it seems interesting to consider a plausible generalization of Schrödinger equation in particular in the context of viscous dissipation method. First, we could write Schrödinger equation for a charged particle interacting with an external electromagnetic field [61] in the form of equation (28) and (85):

$$[(-i\hbar\nabla_\mu - qA_\mu)(-i\hbar\nabla^\mu - qA^\mu)\Psi] = [-i2m.\partial/\partial t + 2mU(x)]\Psi. \quad (99)$$

In the presence of electromagnetic potential [69], one could include another term into the LHS of equation (99):

$$[(-i\hbar\nabla_\mu - qA_\mu)(-i\hbar\nabla^\mu - qA^\mu) + eA_o]\Psi = 2m[-i\partial/\partial t + U(x)]\Psi. \quad (100)$$

This equation has the physical meaning of Schrödinger equation for a charged particle interacting with an external electromagnetic field, which takes into consideration Aharonov effect [69]. Topological phase shift becomes its immediate implication, as already considered by Kiehn [61].

Therefore, in the context of quaternionic representation of Schrödinger equation [70], one could write equation (100) in terms of equation [22a]:

$$[\{D\} * + eA_o] \Psi = 2m [-i\partial/\partial t + U(x)] \Psi. \quad (101)$$

In the context of topological phase shift [69], it would be interesting therefore to find the scalar part of equation (101) in experiments [8].

As described above, one could also derive equation (96) from scale- relativistic Schrödinger equation [43][44]. It should be noted here, however, that Nottale's method [43][44] differs appreciably from the viscous dissipative Navier-Stokes approach of Kiehn, because Nottale only considers his equation in the Euler-Newton limit [67][68]. Nonetheless, as we shall see, it is possible to find a generalization of Schrödinger equation from Nottale's approach in similar form with equation (101). In order to do so, first we could rewrite Nottale's generalized Schrödinger equation via diffusion method [67][71]:

$$\begin{aligned} i2m\gamma [-(i\gamma + a(t)/2) (\partial\psi/\partial x)^2 \psi^{-2} + \partial \ln \psi/\partial t] \\ + i\gamma a(t). (\partial^2\psi/\partial x^2) / \psi = \Phi + a(x) \end{aligned} \quad (102)$$

where  $\psi, a(x)$ ,  $\Phi$ ,  $\gamma$  each represents classical wave function, an arbitrary constant, scalar potential, and a constant, respectively. If the function  $f(t)$  is such that

$$a(t) = -i2\gamma, \quad \alpha(x) = 0, \quad (103)$$

$$\gamma = \hbar/2m \quad (104)$$

then one recovers the original Schrödinger equation (85).

Further generalization is possible if we rewrite equation (102) in quaternion form similar to equation (101):

$$\begin{aligned} i2m\gamma [-(i\gamma + a(t)/2) (\{\nabla\}*)^2\psi^{-2} + \partial \ln \psi/\partial t] \\ + i\gamma.a(t). (\{\nabla'\}*) / \psi = \Phi + a(x) \end{aligned} \quad (105)$$

Alternatively, with respect to our superfluid dynamics interpretation [13], one could also get Schrödinger equation from simplification of Ginzburg-Landau equation. This method will be discussed subsequently. It is known that Ginzburg-Landau equation can be used to explain various aspects of superfluid dynamics [16][17][18].

According to Gross, Pitaevskii, Ginzburg, wavefunction of N bosons of a reduced mass  $m^*$  can be described as [55]:

$$-(\hbar^2/2m^*).\nabla^2\psi + \kappa |\psi|^2 \psi = i\hbar.\partial\psi/\partial t \quad (106)$$

For some conditions (where the temperature dependence of the density of Cooper pairs,  $n_s$ , is just the square of order parameter. Or  $|\psi|^2 \approx n_s = A(T_c - T)$ ), then it is possible

to replace the potential energy term in equation (106) with Hulthen potential. This substitution yields:

$$-(\hbar^2/2m^*)\cdot\nabla^2\psi + V_{Hulthen}\cdot\psi = i\hbar\cdot\partial\psi/\partial t \quad (107)$$

where

$$V_{Hulthen}(r) = \kappa |\psi|^2 \approx -Ze^2\cdot\delta\cdot e^{-\delta r}/(1 - e^{-\delta r}) \quad (108)$$

This equation (108) has a pair of exact solutions. It could be shown that for small values of  $\delta$ , the Hulthen potential (108) approximates the effective Coulomb potential, in particular for large radius [14b]:

$$V_{Coulomb}^{eff} = -e^2/r + \ell(\ell + 1)\cdot\hbar^2/(2mr^2) \quad (109)$$

Therefore equation (109) could be rewritten as:

$$-\hbar^2\nabla^2\psi/2m^* + [-e^2/r + \ell(\ell + 1)\cdot\hbar^2/(2mr^2)]\cdot\psi = i\hbar\cdot\partial\psi/\partial t \quad (110)$$

For large radii, second term in the square bracket of LHS of equation (110) reduces to zero [54],

$$\ell(\ell + 1)\cdot\hbar^2/(2mr^2) \rightarrow 0 \quad (111)$$

so we can write equation (110) as:

$$(-\hbar^2\nabla^2\psi/2m^* + U)\cdot\psi = i\hbar\cdot\partial\psi/\partial t \quad (112)$$

where Coulomb potential can be written as:

$$U = -e^2/r \quad (113)$$

This equation (112) is nothing but Schrödinger equation (85). Therefore we have re-derived Schrödinger equation from simplification of Ginzburg-Landau equation, in the limit of small screening parameter. Calculation shows that introducing this Hulthen effect (108) into equation (107) will yield different result only at the order of  $10^{-39}$  m compared to prediction using equation (110), which is of course negligible. Therefore, we conclude that for most celestial quantization problems the result of TDGL-Hulthen (110) is *essentially* the same with the result derived from equation (85). Now, to derive equation (96) from Schrödinger equation, the reader is advised to see Nottale's scale-relativistic method [43][44].

What we would emphasize here is that this derivation of Schrödinger equation from Ginzburg-Landau equation is in good agreement with our previous conjecture that equation (90) implies macroquantization corresponding to superfluid-quantized vortices. This conclusion is the main result of this section. It is also worthnoting here that there is recent attempt to introduce Ginzburg-Landau equation in the context of microtubule dynamics [72], which implies wide applicability of this equation.

In the following section, we would extend this argument by noting that macroquantization of celestial systems implies the *topological* character of superfluid-quantized vortices, and cosmic microwave background radiation is also an indication of such topological superfluid vortices.

## 7. Further Note: Signatures of Bose-Einstein Cosmology

It is known that CMBR temperature (2.73K) is conventionally assumed to come from the hot early Universe, which then cools adiabatically to the present epoch. Nonetheless this description is not without problems, such as how to consider the small temperature fluctuations of CMBR as the seeds that give rise to large-scale structure such as galaxy formation [73]. Furthermore it is known that CMBR follows Planck radiation law with high precision, so one could argue whether it also indicates that large-scale structures obey quantum-mechanical principles. Therefore we will consider here some alternative hypothesis, which support the idea of low-energy quantum mechanics corresponding to superfluid vortices described in the preceding section.

In recent years, there are alternative arguments suggesting that the Universe indeed resembles the dynamics of  $N$  number of Planckian oscillators. Using similar assumption, for instance Antoniadis *et al.* [74] argue that CMBR temperature could be derived using *conformal invariance* symmetry, instead of using Harrison-Zel'dovich spectrum. Other has derived CMBR temperature from Weyl framework [74a]. Furthermore, if the CMBR temperature 2.73K could be interpreted as low-energy part of the Planck distribution law, then it seems to indicate that the Universe resembles Bose-Einstein condensate [75]. Pervushin *et al.* also argued that CMBR temperature could be derived from conformal cosmology with relative units [76]. These arguments seem to support Winterberg's hypothesis that superfluid phonon-roton aether could explain the origin of cosmic microwave background radiation [18][19].

Of course, it does not mean that CMBR data fits perfectly with Planck distribution law. It has been argued that CMBR data more corresponds to  $q$ -deformed Planck radiation distribution [77]. However, this argument requires further analysis. What interests us here is that there are reasons to believe that a quantum universe based on Planck scale is not merely a pure hypothetical notion, in particular if we consider known analogy between superfluidity and various cosmology phenomena [16][17].

Another argument comes from fractality argument. It has been discovered by Feynman that the typical quantum mechanical paths are non-differentiable and fractal [67]. In this regard, it has been argued that the Universe is embedded in Cantorian fractal spacetime having non-integer Hausdorff dimension [78], and from this viewpoint it could be inferred that the correlated fluctuations of the fractal spacetime is analogous to the Bose-Einstein condensate phenomenon. Interestingly, there is also hypothesis suggesting that Hausdorff dimension could be related to temperature of ideal Bose gas [79].

From these aforementioned arguments, it seems plausible to suppose that that CMBR temperature 2.73K could be interpreted as a signature of Bose-Einstein condensate cosmology. In particular, one could consider [22b] that "this relationship comes directly from Boltzmann's law  $N = B.k.T$ , where  $N$  is the background noise power;  $T$  is the background temperature in degrees Kelvin; and  $B$  is the bandwidth of the background radiation. It follows that the ratio  $(N/kB)$  for the cosmic background radiation is approximately equal to "e", because we usually convert the equation to decibels by taking natural logarithm.



The relationship is a solid one in fact.” From this viewpoint, it seems quite conceivable to explain why CMBR temperature 2.73K is near enough to known number  $e= 2.71828\dots$ , which seems to suggest that the logarithmic form of Schrödinger equation (‘eigentliche Wellengleichung’) [4a] *may have* a deep linkage with this number  $e= 2.71828\dots$

Nonetheless, we recognize that this proposition requires further analysis before we could regard it as conclusive. But we can describe here some arguments to support the new interpretation supporting this Bose-Einstein cosmology argument:

- From Fischer’s argument [13] we know that Bohr-Sommerfeld quantization from superfluid vortice could exhibit at all scales, including celestial quantization. This proposition comes directly from his assertion of *the topological character* of superfluid vortices, because superfluid is topological electronic liquid [27].
- Extending further the aforementioned hypothesis of topological superfluid vortices, then it seems interesting to compare it with topological analysis of COBE-DMR data. G. Rocha *et al.* [80] argue using wavelet approach with Mexican Hat potential that it is possible to interpret the data as clue for a finite torus Universe, albeit not conclusive enough.
- Interestingly, this conjecture could be related to Bulgadaev’s argument [81] suggesting that topological quantum number could be related to torus structure as stable *soliton* [81a]. In effect, this seems to imply that the basic structure of physical phenomena throughout all scales could take the form of topological torus.

In other words, the topological character of superfluid vortices implies that it is possible to generalize superfluid vortices to large scales. And the topological character of CMBR data seems to support our proposition that the universe indeed exhibits topological structures. It follows then that CMBR temperature is topological [80] in the sense that the superfluid nature of background temperature [18][19] could be explained from topological superfluid vortices.

Interestingly, similar argument has been pointed out by a number of authors by mentioning non-Gaussian part of CMBR spectrum. However, further discussion on this issue requires another note.

## 8. Concluding Remarks

It is known that Barut equation could predict lepton mass (and also hadron mass) with remarkable precision. Therefore, in the present article, we attempt to find plausible linkage between Dirac-Maxwell’s isomorphism and Barut-Dirac-Vigier equation. From this proposition we could find a unified wave equation in terms of superfluid velocity (*vierbein*), which then could be used as basis to derive some alternative descriptions of Barut equation. Further experiment is required to verify which equation is the most reliable.

In the present note we submit the viewpoint that it would be more conceivable if we interpret the *vierbein* of the unified wave equation in terms of superfluid velocity, which in turn brings us to the notion of topological electronic liquid. Nonetheless, the proposed

imaginary algebra discussed herein is only at its elementary form, and it requires further analysis in particular in the context of [5a][7][14][28]. It is likely that this subject will become the subject of subsequent paper.

Furthermore, the notion of topological electronic liquid could lead to topological superfluid vortices, which may explain the origin of macroquantization of celestial systems and perhaps also topological character of Cosmic Microwave Background Radiations. Nonetheless, such a proposition requires further analysis before it can be considered as conclusive.

Provided the aforementioned propositions of using superfluid velocity (*vierbein*) to describe unified wave equation correspond to the observed facts, and then in principle it seems to support arguments in favor of possibility to observe condensed-matter hadronic reaction.

## Acknowledgement

The author would thank to Profs. C. Castro, M. Pitkänen, R.M. Kiehn, Ezzat G. Bakhom, A. Kaivarainen, P. LaViolette, F. Smarandache, and E. Scholz, for insightful discussions and remarks. Special thanks go to Prof. C. Castro for suggesting finding linkage between quaternionic Klein-Gordon equation and Duffin-Kemmer-Petiau equation, to Prof. Ezzat G. Bakhom for his remark on Boltzmann distribution and its linkage to CMBR temperature.

## References

- [1] Barut, A.O., *Phys. Rev. Lett.* Vol. 42 (1979). [1a] A.O. Barut, “On the status of hidden variable theories in Quantum mechanics,” *Apeiron* Vol. 2 No. 4, Oct. 1995, p. 97.
- [2] Gsponer, A., & J-P. Hurni, *Found. Phys. Lett.* Vol. 14 No.1 (2001) 77-85, preprint arXiv:math-ph/0201049. [2a] Gsponer, A., & J-P. Hurni, hep-ph/0201193. [2b] Gsponer, A., *Int. J. Theor. Phys.* 41 (2002) 689-694, preprint arXiv:math-ph/0201053.
- [3] Varlamov, V.V., *Annales Fondation Louis de Broglie* Vol. 27 no. 2(2002), [3a] arXiv:hep-th/9709051 (1997).
- [4] Post, E.J., *Annales Fondation Louis de Broglie* no. 2, 217-240 (2002). [4a] Englman, R., & H. Yahalom, arXiv:physics/0406149 (2004).
- [5] Dvoeglazov, V.V., arXiv:math-ph/0503008 (2005). [5a] Kruglov, S.I., *Annales Fondation Louis de Broglie* Vol. 29 (2004) arXiv:quant-ph/0408056 (2004)
- [6] Vigier, J-P., “Fundamental problems in quantum physics,” *Apeiron* Vol. 2 No. 4, Oct. 1995, (1995) p.114.
- [7] Ulrych, S, arXiv:hep-th/9904170 (1999); [7a] Ulrych, S., physics/0009079.
- [8] Aharonov, Y., *et al.*, arXiv:quant-ph/0311155 (2003).
- [9] Hofer, W.A., “Beyond Uncertainty: the internal structure of electron and photon,” arXiv:physics/9611009 (1996).
- [10] Sklarz, S., & L. Horwitz, arXiv:physics/0104019 (2001).
- [11] Cui, H.Y., arXiv:physics/0103019 (2001); [11a] arXiv:physics/0408025 (2004); [11b] arXiv:physics/0409023 (2004).
- [12] Carter, B., & D. Langlois, arXiv:hep-th/9507059 (1995). [12a] Carter, B., & D. Langlois, *Phys. Rev. D* **51** (1995), 5855-64.
- [13] Fischer, U.W., arXiv:cond-mat/9907457 (1999).
- [14] Antonuccio, F., arXiv:hep-th/9812036 (1998); [14a] arXiv:hep-th/9408166; [14b] Alhaidari, A., arXiv:math-ph/0405022 (2004); [14c] Adler, S.L., arXiv:hep-th/9306009.
- [15] Oudet, X., “The quantum state and the doublets,” *Annales Fondation Louis de Broglie* Vol. **25** No.1, 24p (2000).
- [16] Zurek, W., “Cosmological experiments in superfluids and superconductors,” in *Proc. Euroconference Formation and Interaction of Topological Defects*, A. Davis & R. Brandenberger (eds.) Plenum (1995); preprint at arXiv:cond-mat/9502119. [16b] Barcelo, C., *et al.*, “Analogue gravity from Bose-Einstein condensate,” *Class. Quantum Grav.* **18**, 1137-1156 (2001).
- [17] Volovik, G., “Superfluid analogies of cosmological phenomena,” arXiv:gr-qc/0005091 (2000a); [17b] Volovik, G., “Links between gravity and dynamics of quantum liquids,” *Int. Conf. “Cosmology. Relativistic Astrophysics. Cosmoparticle Physics” (COSMION-99)* (2000) preprint at arXiv:gr-qc/0004049; [17c] Volovik, G., arXiv:gr-qc/0104046 (2001); [17d] Nozieres, P., & D. Pines, *The theory of quantum liquids: Superfluid Bose Liquid*. Wesley Publ. Co. Inc., 116-124 (1990).
- [18] Winterberg, F., *Z. Naturforsch.*, **57a** (2002) 202-204; presented at *the 9<sup>th</sup> Canadian Conf. on General Relativity and Relativistic Astrophysics*, Edmonton, May 24-26, 2001.

- [19] Winterberg, F., “Maxwell’s Aether, the Planck Aether hypothesis, and Sommerfeld’s Fine Structure Constant, ”<http://www.cet.sunderland.ac.uk> (2002), <http://www.znaturforsch.com/56a/56a0681.pdf> .
- [20] Kaivarainen, A., arXiv:physics/0207027 (2002)
- [21] Kaivarainen, A., “Hierarchic models of turbulence, superfluidity and superconductivity,” arXiv:physics/0003108 (2000). Also in <http://www.karelia.ru>
- [22] Bakhoun, E., “Fundamental disagreement of wave mechanics with relativity,” arXiv:physics/0206061 (2002) p. 5-7. [22a] Bakhoun, E., physics/0207107. [22b] Bakhoun, E., email communication, Sept. 24<sup>th</sup> 2005.
- [23] Goenner, H.F.M., “On the history of the unified field theories”, *Living Rev. Relativity* Vol. 7, 102 (2004) <http://www.livingreviews.org/lrr-2004-2>
- [24] Oleinik, V.P., *Nonlin. Math. Phys.*, Vol. 4 No. 1-2 (1997) 180-189. [24a] Oleinik, V.P. *et al.*, “On quantum dynamics of the self-acting electron,” ( ).
- [25] Castro., C., & M. Pavsic, “The extended relativity in Clifford-spaces,” commissioned review to appear in *Int. J. Mod. Phys. D* (2004).
- [26] Feynman, R., *et al.*, *The Feynman Lectures on Physics*, Addison-Wesley, Reading, MA, Vol. II, (1964) p. 1-3.
- [27] Wiegmann, P., arXiv:cond-mat/9808004 (1998).
- [28] Dahm, R., arXiv:hep-ph/9601207 (1996).
- [29] Rowlands, P., arXiv:hep-ph/0301071 (2003).
- [30] Meessen, A., *Found. of Phys.*, no. 29 (2000) 281-316.
- [31] Henley, E., & J. Schiffer, arXiv:nucl-th/9807041 (1998) p.11.
- [32] Baez, J., arXiv:math.RA/0105155 (2001).
- [33] Waser, A., “Quaternions in electrodynamics,” (2001) <http://www.aw-verlag.ch>
- [34] Kassandrov, V.V., *Grav. & Cosmology* Vol.1(1995) arXiv:gr-qc/0007027 (2000); [34a] arXiv:gr-qc/00070276 (2000).
- [35] Baylis, W.E., arXiv:quant-ph/0202060 (2002).
- [36] van Dongen, J., arXiv:gr-qc/0009087 (2000) p.5
- [37] Consoli, M., arXiv:gr-qc/0204106 (2002). [37a] Consoli, M., & E. Costanzo, arXiv:hep-ph/0311317 (2003).
- [38] Ibison, M., “Electrodynamics in the Zero-Point Field: On the equilibrium spectral energy distribution, and the origin of inertial mass.” *Found. Phys. Letter* Vol. 16 No. 1 (2003) 83-90.
- [39] Ying-Qiu, G., “Some properties of the spinor soliton,” *Advances in Applied Clifford Algebras* 8 No. 1 (1998) 17-29.
- [40] Woon, S., DAMTP-R-97/33, arXiv:hep-th/9707206 (1997) p. 18-21.
- [41] Fauser, B., arXiv:hep-th/9908200 (1999).
- [42] Spohn, H., arXiv:quant-ph/9911065 (1999).

- [43] Nottale, L., *et al.*, *Astron. Astrophys.* **322**, (1997) 1018.
- [44] Nottale, L., *Astron. Astrophys.* **327**, (1997) 867-889.
- [45] Nottale, L., G. Schumacher, & E.T. Levefre, *Astron. Astrophys.* **361**, (2000) 379-387; preprint at <http://www.daec.obspm.fr/users/nottale>
- [46] Ohba, I., “Some stochastic aspect of quantization”, *Pramana J.Phys.*, Indian Academy of Sciences, Vol. 59. No. 2 (2002) 397-404.
- [47] Rubi, A., & J. Rubi, “The quantization of solar-like gravitational systems,” *Fizika B* **7** Vol. 1, 1-13 (1998).
- [48] Agnese, A.G., & R. Festa, “Discretization of the cosmic scale inspired from the Old Quantum Mechanics,” *Proc. Workshop on Modern Modified Theories of Gravitation and Cosmology* 1997, preprint arXiv:astro-ph/9807186 (1998).
- [49] Christianto, V., *Apeiron* Vol. 11 No. 3 (2004), preprint at <http://reachme.at/coolbit>
- [49a] Christianto, V., *AFLB* Vol. 31 no. 1 (2006)  
URL:<http://www.ensmp.fr/aflb/AFLB-311/aflb311m370.pdf>
- [49b] Christianto, V., *Apeiron* VOL. 11 (2004)  
<http://www.slac.stanford.edu>
- [50] NASA News Release (Jul 2005),  
<http://www.nasa.gov/vision/universe/solarsystem/newplanet-072905.html>
- [51] BBC News (Oct 2004), <http://news.bbc.co.uk/1/hi/sci/tech/4730061.stm>
- [52] Brown, M., *et al.*, *ApJ. Letters* (Aug. 2004). Preprint arXiv: astro-ph/0404456 (2004); *ApJ.* forthcoming issue (2005), astro-ph/0504280 (2005).
- [53] Brown, M. (Jul. 2005), <http://www.gps.caltech.edu/~mbrown/planetlila/>
- [54] Pitkänen, M., <http://www.physics.helsinki.fi/~matpitka/articles/nottale.pdf>
- [55] Infeld, E., *et al.*, arXiv:cond-mat/0104073 (2001).
- [56] Lodder, J.J., submitted to *Physica A*, arXiv:hep-th/9405265 (1994).
- [57] Cozzini, M., & S. Stringari, arXiv:cond-mat/0211294 (2002).
- [58] Marchuk, N., “A model of the composite structure of quarks and leptons with SU(4) gauge symmetry,” arXiv:hep-ph/9801382 (1998).
- [59] Cohen, N., *et al.*, *Electronic Journal of Linear Algebra* **7** (2000), arXiv:math-ph/9907015 (1999).
- [60] Kruglov, S.I., arXiv:hep-ph/0507027 (2005); [60a] Kruglov, S.I., “Dirac-Kahler equation,” arXiv:hep-th/0110060; [60b] Kruglov, S.I., hep-th/0110251 (2001).
- [61] Kiehn, R.M., “An interpretation of wavefunction as a measure of vorticity,” <http://www22.pair.com/csdc/pdf/cologne.pdf> (1989).
- [62] de Andrade, L.G., & C. Sivaram, arXiv:hep-th/9811067 (1998). [62a] de Andrade, L.G., gr-qc/0405062.
- [63] Kivotides, D., arXiv:physics/0405033 (2004).

# Cartan-Weyl space-time, Torsion fields, and Navier-Stokes

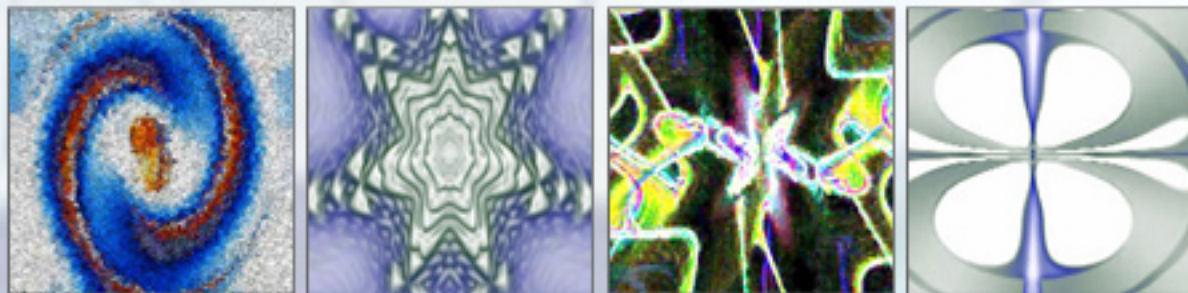

# Torsion Fields, Cartan-Weyl Space-Time and State-Space Quantum Geometries, Brownian Motions, and their Topological Dimension

Diego L. Rapoport

Department of Sciences and Technology, Universidad Nacional de Quilmes  
Buenos Aires, Argentina <sup>1</sup>

**Summary:** We review the relation between space-time geometries with torsion fields (the so-called Riemann-Cartan-Weyl (RCW) geometries) and their associated Brownian motions. In this setting, the metric conjugate of the trace-torsion one-form is the drift vector field of the Brownian motions. Thus, in the present approach Brownian motions are -in distinction with Nelson's Stochastic Mechanics- space-time structures. We extend this to the state-space of non-relativistic quantum mechanics and discuss the relation between a non-canonical quantum RCW geometry in state-space associated with the gradient of the quantum-mechanical expectation value of a self-adjoint operator. A particular case is given by the generalized laplacian operator defined by a RCW geometry, which is the generator of the space-time Brownian motions. We discuss the reduction of the wave function in terms of a RCW quantum geometry in state-space. We characterize the Schroedinger equation in terms of the RCW geometries and Brownian motions, for systems under observation as well as those unobserved. Thus, in this work, the Schroedinger field is a torsion generating field. In this work the U and R processes -in the sense of R. Penrose- are associated to RCW geometries and their Brownian motions, the former to RCW space-time geometries and their associated Brownian motions, and the latter to their extension to the state-space of nonrelativistic quantum mechanics given by the projective Hilbert space. In this setting, the Schroedinger equation can be either linear or nonlinear. We discuss the problem of the many times variables and the relation with dissipative processes. We present as an additional example of RCW geometries and their Brownian motions, the dynamics of viscous fluids obeying the invariant Navier-Stokes equations. We introduce in the present setting an extension of R. Kiehn's approach to dynamical systems starting from the notion of the topological dimension of one-forms, to apply it to the trace-torsion one-form whose metric conjugate is the Brownian motion's drift vector-field and discuss the topological notion of turbulence. We discuss the relation between our setting and the Nottale theory of Scale Relativity, and the work of Castro and Mahecha in this volume in nonlinear quantum mechanics, Weyl geometries (which are not to be confused with the RCW geometries) and the quantum potential. In our setting, the quantum potential is found to coincide (up to a conformal factor) with the metric scalar curvature. We discuss the possible relations between the present approach and the nonlocal universal correlations

---

<sup>1</sup>E-mail address: diego.rapoport@gmail.com

between dissipative systems, first found by Kozyrev, and subsequently in diverse geophysical, solar and ionospheric observations. We discuss the possible relations between the present gauge theory that can be introduced in terms of Einstein's lambda transformations, and the so-called Global Scaling theory due to Hartmut Muller, and his predictions of the existence of a universal fractal structure associated to the logarithmic scale for universal scales in Nature.

## 1 INTRODUCTION

In a series of articles [1,2], we have presented a fusion between space-time structures and Brownian motions, in which a complementarity of the objects characterizing the Brownian motion, i.e. the noise tensor which produces a metric, and the drift vector field which describes the average velocity of the Brownian motion whenever this takes place in space-time. These space and time structures, which can be defined starting from flat Euclidean or Minkowski space-time, have in addition to a metric, a torsion tensor which is formed from the metric conjugate of the drift vector field, and the laplacian operator defined by this geometrical structure is the differential generator of the Brownian motions. Thus, in this equivalence, one can choose the Brownian motions as the original structures determining a space-time structure, or conversely, the space-time structures produce a Brownian motion process. Thus, in view that the space and time geometries can be seen as associated with an extension of the theory of gravitation which in fact was first explored in joint work by Einstein with Cartan [3], then the foundations for the gravitational field, at least those associated to this restricted case of torsion reduced to the trace, can be found in these Brownian motions. Thus, in this equivalence, lies a characterization of the Universe in which due to the self-similarity of Brownian motions with its associated fractal structures, and the infinite velocity propagation of diffusion processes, point to a phenomenology which is not the classical mechanical metaphor, but one in which interactions at a point are imparted in no time to the whole Universe, while an hologram picture of reality (which recalls the Bohm conception of implicit order [68]), appears as its natural expression of universal scales that have been gauged to produce the actual geometries and the associated Brownian motions. Indeed, these space-time geometrical structures can be introduced by the Einstein  $\lambda$  transformations on the tetrad fields, from which the usual Weyl scale transformations can be deduced, but contrarily to Weyl geometries, these structures have torsion and they are integrable in contrast with Weyl's theory (see Castro and Mahecha in this volume). We have called these connections as RCW structures (short for Riemann-Cartan-Weyl) [2,4]. A different meaning for RCW structures is found in [77] in which it is



referred to connections which are metric compatible with torsion, not necessarily restricted to the trace-torsion, in spite of the common designation in [78].

This description in terms of gauging the scale transformations, begs the question about how universal scales can be to be able to produce a Universe of diversity which gives place to the phenomenae we call life, the quantum mechanical scales and still the planetary and galactic scales?<sup>2</sup>

We can further enquire what is the relation between the aether and a Universe described in terms of this equivalence, in which due to the fact that torsion is a non-metric geometrical object describing a topological obstruction to triviality, i.e. the breaking of closure of infinitesimal parallelograms in the particular scale we are describing this equivalence, so that the presence of a flow is intuitively evoked by this geometry, and the aether? This may seem strange to most of the readers, since the Michelson-Morley experiments seemingly disproved the existence of a background fluid, which years later reappeared in quantum field theory in the guise of the vacuum fluctuations <sup>3</sup>

This negative result called for the fusion of space and time, in a single structure which we know as Minkowski space, but for which the founding fathers of modern physics found initially to be abstruse. The fact is that the Lorentz group does not depend on the existence or not of an aether, and they have been associated by V. Fock to particles as space-time structures associated with solutions of the eikonal equation for which in Minkowski space this equation is Lorentz-invariant; see [35]. Furthermore, if an aether would exist, the Lorentz transformations, in contrary to common belief, does not loose its place, because they become the set of transformations by which two arbitrary observers can

---

<sup>2</sup>The answer to this may come from the research by Hartmut Muller, currently called Global Scaling, starting from research by the Russian biologist, Cislenco. This researcher discovered that biological species sizes can be represented in a logarithmic scale where they appear concentrated in specific equally distanced intervals; see. Cislenco, Structure of Fauna And Flora With Regard to Body Size of Organisms ( Lomonosov-University Moscow, 1980). Analysis of data of natural processes and structures on all scales, from the cosmological to the quantum, have shown a similar behavior. The scales in which the Universe appears to be related to a fractal structure on this logarithmic scale, and the void sets of this vacuum are nodal sets for a stationary wave that appears from a model of interacting classical particles, and associated with the creation or annihilation of particles, or, more universally, of structures. Thus, one can apply as a general method Muller's findings, to the analysis with this fractal structure of a time series of experimental data of arbitrary phenomenae, and thus to be able to deduce the possibility of creation (or annihilation) of hitherto unknown structures; see [2]. Remarkably, this resonant effects of the vacuum through the nodes, has allowed to produce transference of information, concretely, computer files between computers unconnected through internet or other tangible communication scheme; see [30]. In the context of our theory, the logarithmic scale is gauged and introduces the exact term of the trace-torsion one-form, whose metric conjugate is part of the drift of the underlying Brownian motion through which the teleportation may be produced. Thus, the universality of global scaling laws lead to gauge dependent Brownian motions of all systems.

<sup>3</sup>There is a strong controversy about the interpretations of the Michelson-Morley experiments. The experiments were repeated extensively by Miller who interpreted his results as yielding a positive result for the existence of the aether [41]. More contemporary experiments with different settings, may point out to the existence of the aether [42][43].

agree in the existence of a lump of space-time associated to the solution of the eikonal equation. Furthermore, the velocity of light as a universal factor does not lose its place. What about General Relativity (GR), vis-a-vis the existence of background Brownian motions, where we recall that GR appeared to give a geometrical invariant extension of Minkowski space-time precisely to account of the existence of massive objects as deformations of the flat space-time? Does the principle of general covariance lose its ground as a basic tenant for the universality of the laws of physics? In this regard the fact that the theory of Brownian motion cannot be formulated without a diffeomorphism invariant distinction between the first and second moments, i.e. between the drift and the noise tensor, for which it is indispensable to introduce the notion of a linear connection [24,25,26]. This gives further support, albeit from an unexpected quantum status, to the relevance of the general principle of covariance, but now stemming from a more fundamental non-differentiable fractal level <sup>4</sup>.

In this article we shall treat the problem of non-relativistic quantum mechanics in terms of diffusion processes both in spacetime and the state-space of quantum mechanics. Thus, in this approach, it will appear that the Schroedinger field can be associated with a scale field producing a distortion in the vacuum, and introducing as well the associated Brownian motions. There have been numerous attempts to relate non-relativistic quantum mechanics to diffusion equations; the most notable of them is Stochastic Mechanics, due to Nelson [14]. Already Schroedinger proposed in 1930-32 that his equation should be related to the theory of Brownian motions, and proposed a scheme he was not able to achieve, the so-called interpolation problem which requires to describe the Brownian motion and the wave functions in terms of interpolating the initial and final densities in a given time-interval [27]. More recently Nagasawa presented a solution to this interpolation problem and further elucidated that the Schroedinger equation is in fact a Boltzmann equation [38]. Neither Nagasawa nor Nelson presented these Brownian motions as spacetime structures, but rather as matter fields *on* the vacuum. While Nelson introduced artificially a forward and backward stochastic derivatives to be able to reproduce the Schroedinger equation as a formally time-symmetric equation, Nagasawa was able to solve the interpolation problem in terms of the forward diffusion process and its adjoint backward process, from which without resort to the ad-hoc constructions due to Nelson, he was able to prove that this was related to the Kolmogorov characterization of time-irreversibility of diffusion processes in terms of the non-exact terms of the drift, here related to the trace-torsion.

---

<sup>4</sup>Einstein somewhat conceded to the criticism of the so called operationalists, as Bridgeman and Kretschmann, on downplaying the role of the Principle of General Covariance; see E. Kretschmann, *Ann. der Physik* **53**, 575 (1917), P.W. Bridgeman, *Natural of Physical Theory*, Princeton Univ. Press (1936); if it would not have been by the developments of the mathematical theory of Brownian motions, and still, the inception of gauge-theoretical geometrical methods in statistical and condensed matter physics at its very roots, this criticism of the geometrical approach, and further, of a topological approach, would have prevailed.

In spite of the ad-hoc character of Nelson's approach, a similar approach to quantization in terms of an initial fractal structure of space-time and the introduction of Nelson's forward and backward stochastic derivatives, was developed by Nottale in his Scale Theory of Relativity [31]. Remarkably, his approach has promoted the Schroedinger equation as valid for large scale structures, and predicted the existence of exo-solar planets which were observationally verified to exist [34]. This may further support the idea that the RCW structures introduced in the vacuum by scale transformations, are valid, as any topological approach would be, independently of the scale in which the associated Brownian motions and equations of quantum mechanics are posited. Furthermore, Kiehn has proved that the Schroedinger equation in spatial 2D can be exactly transformed into the Navier-Stokes equation for a compressible fluid, if we further take the kinematical viscosity  $\nu$  to be  $\frac{\hbar}{m}$  with  $m$  the mass of the electron;; see ref. [33]. As we proved in [1] and [32] the Navier-Stokes equations share with the Schroedinger equation, that both have a RCW geometry at their basis; while in the Navier-Stokes equations the trace-torsion is  $\frac{-1}{2\nu}u$  with  $u$  the time-dependent velocity one-form of the viscous fluid, in the Schroedinger equation, the trace-torsion one-form incorporates the logarithmic differential of the wave function -just like in Nottale's theory [31]- and further the electromagnetic potential terms of the trace-torsion. This correspondence between trace-torsion one-forms is what lies at the base of Kiehn's correspondance, with an important addendum: While in the approach of the Schroedinger equation the probability density is related to the Schroedinger scale factor (in incorporating the complex phase) and the Born formula turns out to be a formula and not an hypothesis, under the transformation to the Navier-Stokes equations it turns out that the probability density of non-relativistic quantum mechanics, is the entrosphy density of the fluid, i.e. the square of the vorticity, which thus plays a *geometrical* role that substitutes the probability density. Thus, in this approach, while there may be virtual paths sustaining the random behaviour of particles (as is the case also of the Navier-Stokes equations [1],[32]) and the interference such as in the two-slit experiments can be interpreted as a superposition of Brownian paths [38], the probability density has a purely geometrical fluid-dynamical meaning (the squared length of the vorticity vector field). Finally, we shall present the relation between what we can now call RCW quantum geometries, with the representation of the Schroedinger equation in the projective state-space of non-relativistic quantum mechanics, and further present the problem of the reduction of the wave function, as related to a non-canonical geometry in state-space. This quantum RCW geometry has a metric which is not the usual Fubini-Study metric, but is related to an extension of the classical symplectic geometry treatment of the Schroedinger function in state-space, to include the observation process in terms of a noise term and a trace-torsion drift given by (a modification of) the gradient of the Hamiltonian function corresponding to the symplectic formalism. This Hamiltonian function is none other that the quantum mechanical expectation function defined by the quantum Hamiltonian

operator, or more specifically, it can be the Laplacian operator associated to the RCW geometry which has a correlate as a Brownian motion in space-time. Thus, if one incorporates the observation process into the theory, still RCW geometries will play an important role, since the Schroedinger symplectic vector field is the natural drift vector field in state-space whenever the noise coefficient is zero.

## 2 RIEMANN-CARTAN-WEYL GEOMETRIES

In this section we follow our articles in [1,2]. In this article  $M$  denotes a smooth connected compact orientable  $n$ -dimensional manifold (without boundary). While in our initial works, we took for  $M$  to be spacetime, there is no intrinsic reason for this limitation, in fact it can be an arbitrary configuration manifold and still a phase-space associated to a dynamical system. The paradigmatic example of the latter, is the projective space associated to a finite-dimensional Hilbert-space of a quantum mechanical system. We shall further provide  $M$  with a linear connection described by a covariant derivative operator  $\nabla$  which we assume to be compatible with a given metric  $g$  on  $M$ , i.e.  $\nabla g = 0$ . Given a coordinate chart  $(x^\alpha)$  ( $\alpha = 1, \dots, n$ ) of  $M$ , a system of functions on  $M$  (the Christoffel symbols of  $\nabla$ ) are defined by  $\nabla_{\frac{\partial}{\partial x^\beta}} \frac{\partial}{\partial x^\gamma} = \Gamma(x)_{\beta\gamma}^\alpha \frac{\partial}{\partial x^\alpha}$ . The Christoffel coefficients of  $\nabla$  can be decomposed as:

$$\Gamma_{\beta\gamma}^\alpha = \left\{ \begin{matrix} \alpha \\ \beta\gamma \end{matrix} \right\} + \frac{1}{2} K_{\beta\gamma}^\alpha. \quad (1)$$

The first term in (1) stands for the metric Christoffel coefficients of the Levi-Civita connection  $\nabla^g$  associated to  $g$ , i.e.  $\left\{ \begin{matrix} \alpha \\ \beta\gamma \end{matrix} \right\} = \frac{1}{2} \left( \frac{\partial}{\partial x^\beta} g_{\nu\gamma} + \frac{\partial}{\partial x^\gamma} g_{\beta\nu} - \frac{\partial}{\partial x^\nu} g_{\beta\gamma} \right) g^{\alpha\nu}$ , and

$$K_{\beta\gamma}^\alpha = T_{\beta\gamma}^\alpha + S_{\beta\gamma}^\alpha + S_{\gamma\beta}^\alpha, \quad (2)$$

is the cotorsion tensor, with  $S_{\beta\gamma}^\alpha = g^{\alpha\nu} g_{\beta\kappa} T_{\nu\gamma}^\kappa$ , and  $T_{\beta\gamma}^\alpha = (\Gamma_{\beta\gamma}^\alpha - \Gamma_{\gamma\beta}^\alpha)$  the skew-symmetric torsion tensor. We are interested in (one-half) the Laplacian operator associated to  $\nabla$ , i.e. the operator acting on smooth functions on  $M$  defined as

$$H(\nabla) := 1/2 \nabla^2 = 1/2 g^{\alpha\beta} \nabla_\alpha \nabla_\beta. \quad (3)$$

A straightforward computation shows that  $H(\nabla)$  only depends in the trace of the torsion tensor and  $g$ , since it is

$$H(\nabla) = 1/2 \Delta_g + \hat{Q}, \quad (4)$$

with  $Q := Q_\beta dx^\beta = T_{\nu\beta}^\nu dx^\beta$  the trace-torsion one-form and where  $\hat{Q}$  is the vector field associated to  $Q$  via  $g$ :  $\hat{Q}(f) = g(Q, df)$ , for any smooth function

$f$  defined on  $M$ . Finally,  $\Delta_g$  is the Laplace-Beltrami operator of  $g$ :  $\Delta_g f = \text{div}_g \text{grad} f$ ,  $f \in C^\infty(M)$ , with  $\text{div}_g$  the Riemannian divergence. Thus for any smooth function, we have  $\Delta_g f = 1/[\det(g)]^{\frac{1}{2}} g^{\alpha\beta} \frac{\partial}{\partial x^\beta} ([\det(g)]^{\frac{1}{2}} \frac{\partial}{\partial x^\alpha} f)$ . Furthermore, the second term in (4), i.e.  $\hat{Q}$  coincides with the Lie-derivative with respect to the vectorfield  $\hat{Q}$ :  $L_{\hat{Q}} = i_{\hat{Q}}d + di_{\hat{Q}}$ , where  $i_{\hat{Q}}$  is the interior product with respect to  $\hat{Q}$ : for arbitrary vectorfields  $X_1, \dots, X_{k-1}$  and  $\phi$  a  $k$ -form defined on  $M$ , we have  $(i_{\hat{Q}}\phi)(X_1, \dots, X_{k-1}) = \phi(\hat{Q}, X_1, \dots, X_{k-1})$ . Then, for  $f$  a scalar field,  $i_{\hat{Q}}f = 0$  and

$$L_{\hat{Q}}f = (i_{\hat{Q}}d + di_{\hat{Q}})f = i_{\hat{Q}}df = g(Q, df) = \hat{Q}(f). \quad (5)$$

Thus, our laplacian operator admits being written as

$$H_0(g, Q) = \frac{1}{2}\Delta_g + L_{\hat{Q}}. \quad (6)$$

Consider the family of zero-th order differential operators acting on smooth  $k$ -forms, i.e. differential forms of degree  $k$  ( $k = 0, \dots, n$ ) defined on  $M$ :

$$H_k(g, Q) := 1/2\Delta_k + L_{\hat{Q}}, \quad (7)$$

In the first summand of the r.h.s. of (7) we have the Hodge operator acting on  $k$ -forms:

$$\Delta_k = (d - \delta)^2 = -(d\delta + \delta d), \quad (8)$$

with  $d$  and  $\delta$  the exterior differential and codifferential operators respectively, i.e.  $\delta$  is the adjoint operator of  $d$  defined through the pairing of  $k$ -forms on  $M$ :  $(\omega_1, \omega_2) := \int \otimes^k g^{-1}(\omega_1, \omega_2) \text{vol}_g$ , for arbitrary  $k$ -forms  $\omega_1, \omega_2$ , where  $\text{vol}_g(x) = \det(g(x))^{\frac{1}{2}} dx$  is the volume density,  $g^{-1}$  denotes the induced metric on 1-forms and  $\otimes^k g^{-1}$  the induced metric on  $k$ -forms. The last identity in eq. (7) follows from the fact that  $d^2 = 0$  so that  $\delta^2 = 0$ . Since this operator when  $k = 0$  coincides with the Laplace-Beltrami operator  $\Delta_g$ , we see that from the family defined in eq. (7) we retrieve for scalar fields ( $k = 0$ ) the operator  $H(\nabla)$  defined in (4). The Hodge laplacian can be further written expliciting the Weitzenbock metric curvature term, so that when dealing with  $M = R^n$  provided with the Euclidean metric,  $\Delta_k$  is the standard Euclidean laplacian acting on the components of a  $k$ -form defined on  $R^n$  ( $0 \leq k \leq n$ ).

Therefore, assuming that  $g$  is non-degenerate, we have defined a one-to-one mapping

$$\nabla \rightsquigarrow H_k(g, Q) = 1/2\Delta_k + L_{\hat{Q}}$$

between the space of  $g$ -compatible linear connections  $\nabla$  with Christoffel coefficients of the form

$$\Gamma_{\beta\gamma}^\alpha = \left\{ \begin{array}{c} \alpha \\ \beta\gamma \end{array} \right\} + \frac{2}{(n-1)} \{ \delta_\beta^\alpha Q_\gamma - g_{\beta\gamma} Q^\alpha \}, n \neq 1 \quad (9)$$

and the space of elliptic second order differential operators on  $k$ -forms ( $k = 0, \dots, n$ ).

Remarkably enough, the full torsion does not appear in the Laplacian operator associated to the connection, only the trace-torsion one-form  $Q$  that gives rise through its metric conjugate, to the drift interaction term. But the torsion tensor has as irreducible decomposition the form

$$T_{\beta\gamma}^{\alpha} = \frac{2}{n-1} \delta_{[\beta}^{\alpha} Q_{\gamma]} + \frac{1}{n-1} \epsilon_{\beta\gamma\delta}^n \hat{T}^{\delta} + \bar{T}_{\beta\gamma}^{\alpha}, \quad (10)$$

where

$$\hat{T}_{\beta} = \frac{1}{2} \epsilon_{jins} T^{ins} \quad (11)$$

is the pseudovector term and the completely skew-symmetric term,  $\bar{T}_{\alpha\beta}^m$  which then satisfies

$$\bar{T}_{\alpha\beta\gamma} + \bar{T}_{\beta\gamma\alpha} + T_{\gamma\alpha\beta} = 0, \quad (12)$$

where  $\bar{T}_{\alpha\beta\gamma} = g_{\alpha\delta} \bar{T}_{\beta\gamma}^{\delta}$ . This is the term that was introduced in the joint collaborator by Einstein and Cartan, without identification of the physical nature of the term [3], and later, retaken in the framework of the Poincaré -gauge theory of gravitation, as the spin-angular-density of elementary particles or macroscopic objects [17]. As we shall see already, the pseudovector and completely skew-symmetric terms do not appear in the generalized laplacian, and a fortiori do not appear in the expression of the Brownian motions that generate the RCW geometries. Thus, angular momentum is not a geometrical object which generates the Brownian motions, only the metric through the noise term that generates the metric through the relation we shall see in the next section, and the drift vector field given by the metric-conjugate of the trace-torsion. In other terms, the probability law of the Brownian motions are determined only by the noise and the trace-torsion, so that the angular momentum density plays no fundamental role in this respect. Nevertheless, since the Brownian motions of tensors and ultimately of differential forms, is determined by the probability law and the Brownian motions of the scalar particles and this information is determined by the scalar laplacian, so the diffusion of the angular-momentum is determined by the diffusion of the scalar fields, and naturally we would like to study the diffusion of angular momentum along the paths of the scalar fields. Thus, when considering the Navier-Stokes equations for viscous fluids, where the drift vector field associated to the geometrical-stochastic characterization of these equations is minus the fluid's velocity one-form obeying the Navier-Stokes equations, the diffusion of the angular momentum of the fluid, i.e. of the vorticity two-form could be identically characterized in terms of the diffusion of the Navier-Stokes laplacian, as an operator acting on scalars associated to a

RCW connection. In this case, the diffusion equation for angular momentum is the Navier-Stokes equations for the vorticity, derived by simply applying the exterior differential to the Navier-Stokes equations for the velocity. In fact we can introduce a non-static completely antisymmetric torsion starting from the RCW connections in a most natural form which implies that it can be taken as derived from it and therefore it will propagate along the paths of the scalar particles generated by it. Indeed, it simply amounts to introduce the duality operation given by the Hodge star operator defined by the metric  $g$ ,

$$* : \sec(\Lambda^k T^* M) \rightarrow \sec(\Lambda^{n-k} T^* M), A_k \rightsquigarrow *A_k, \quad (13)$$

and further apply it to the trace-torsion one-form, i.e. we consider the pseudo-three-form  $*Q$ . Thus, if  $\hat{Q}$  denotes the drift vector field given by the  $g$ -conjugate of  $Q$ , then  $*Q = i_{\hat{Q}} \text{vol}_g$ ; see page 362 in Frankel [48]. Thus we note that this duality depends on the choice of an orientation, and thus  $*Q$  has a built-in chirality associated to it. While this pseudo-three-form does not appear in the RCW laplacian, it is not an additional element of the structure, since it is naturally derived from the RCW geometrical structure. As a final comment, the equations of motion for the skew-symmetric torsion thus introduced, have to be deduced from the equations for  $Q$  itself, but we shall not elaborate on this further in the present article.

### 3 RIEMANN-CARTAN-WEYL DIFFUSIONS

In this section we shall present recall the correspondence between RCW connections defined by (9) and diffusion processes of scalar fields having  $H(g, Q)$  as infinitesimal generators (i.g. for short, in the following). For this, we shall see this correspondence in the case of scalars. Thus, naturally we have called these processes as *RCW diffusion processes*. For the extensions to describe the diffusion processes of differential forms, see [1].

For the sake of generality, in the following we shall further assume that  $Q = Q(\tau, x)$  is a time-dependent 1-form. The stochastic flow associated to the diffusion generated by  $H_0(g, Q)$  has for sample paths the continuous curves  $\tau \mapsto x(\tau) \in M$  satisfying the Itô invariant non-degenerate s.d.e. (stochastic differential equation)

$$dx(\tau) = X(x(\tau))dW(\tau) + \hat{Q}(\tau, x(\tau))d\tau. \quad (14)$$

In this expression,  $X : M \times R^m \rightarrow TM$  is such that  $X(x) : R^m \rightarrow TM$  is linear for any  $x \in M$ , the noise tensor, so that we write  $X(x) = (X_i^\alpha(x))$  ( $1 \leq \alpha \leq n$ ,  $1 \leq i \leq m$ ) which satisfies

$$X_i^\alpha X_i^\beta = g^{\alpha\beta}, \quad (15)$$

where  $g = (g^{\alpha\beta})$  is the expression for the metric in covariant form, and  $\{W(\tau), \tau \geq 0\}$  is a standard Wiener process on  $R^m$ . Now, it is important to remark that

here  $m$  can be arbitrary, i.e. we can take noise tensors defined on different spaces, and obtain the space diffusion process. In regards to the equivalence between the stochastic and the geometric picture, this enhances the fact that there is a freedom in the stochastic picture, which if chosen as the originator of the equivalence, points out to a more fundamental basis of the stochastic description. This is satisfactory, since it is impossible to identify all the sources for noise, and in particular those coming from the vacuum, which we take as the source for the randomness.

Here  $\tau$  denotes the time-evolution parameter of the diffusion (in a relativistic setting it should not be confused with the time variable; we shall discuss more this issue further below), and for simplicity we shall assume always that  $\tau \geq 0$ . Indeed, taking in account the rules of stochastic analysis for which  $dW^\alpha(\tau)dW^\beta(\tau) = \delta_\beta^\alpha d\tau$  (the Kronecker tensor),  $d\tau dW(\tau) = 0$  and  $(d\tau)^2 = 0$ , we find that if  $f : R \times M \rightarrow R$  is a  $C^2$  function on the  $M$ -variables and  $C^1$  in the  $\tau$ -variable, then a Taylor expansion yields

$$f(\tau, x(\tau)) = f(0, x(0)) + \left[ \frac{\partial f}{\partial \tau} + H_0(g, Q)f \right](\tau, x(\tau))d\tau + \frac{\partial f}{\partial x^\alpha}(\tau, x(\tau))X_i^\alpha(x(\tau))dW^i(\tau)$$

and thus  $\frac{\partial}{\partial \tau} + H_0(g, Q)$  is the infinitesimal generator of the diffusion represented by integrating the s.d.e. (14). Furthermore, this identity sets up the so-called martingale problem approach to the random integration of linear evolution equations for scalar fields [1], and for the integration of the Navier-Stokes equation [49]. Note, that if we start with eq. (14), we can reconstruct the associated RCW connection by using eq.(15) and the fact that the trace-torsion is the  $g$ -conjugate of the drift, i.e., in simple words, by lowering indexes of  $\hat{Q}$  to obtain  $Q$ .

### 3.1 The Time Variables

Since the Michelson-Morley experiment on the existence of an aether were interpreted as giving negative results with regard to its existence, the introduction of the observer's time variable to account for the Lorentz transformations in the same status of the space variables, was the scheme of development of physics thereafter. Thus the notion of spacetime was born, the Minkowski metric was introduced as its first example, and the geometrization of physics ensued in terms of Lorentzian manifolds, in great measure due to the dissatisfaction of Einstein with regards to Special Relativity. In spite that a Lorentz invariant Brownian motion has been recently constructed by Oron and Horwitz [5] -and further applied to the equivalence of the Maxwell and Dirac-Hestenes equation [2]- in terms of a modification of the Gaussian distribution which turns out to be invariant by Lorentz transformation, the whole program of quantum



mechanics from the point of view of Feynman path integrals and its applications to quantum field theory requires an Euclidean signature for spacetime. Also, the construction of Brownian motions starting from the stochastic differential equations introduces an Euclidean spacetime structure in contrast with the Lorentzian degenerate metrics of General Relativity. So, if we wish to relate the spacetime geometry to Brownian motions *and* quantum mechanics, we need an Euclidean metric. The receipt for this has been to take the analytical continuation in the observer's time variable. Another way of handling this time variable which has to do with an Euclidean signature, is to work with the universal time variable initially proposed by Stueckelberg [7] which by the way was the parameter used in quantum field theory, as we proposed before [2]. This choice can be further substantiated from the divergence-free classical theory of the electron recently proposed by Gill, Zachary and Lindesay [6]. In this theory, we equate the Minkowski metric  $(dt)^2 - (dx)^2 - (dy)^2 - (dz)^2$ , where  $t$  is the time of the observer, with  $(d\tau)^2$ , where  $\tau$  is the time of the source, or still, we can write this in the equivalent Euclidean metric  $(dt)^2 = (d\tau)^2 + (dx)^2 + (dy)^2 + (dz)^2$ . If we write the Lorentz-invariant equations of electromagnetism in the new Euclidean variables  $(\tau, x, y, z)$ , then we get a mathematically equivalent set of equations for electromagnetism; these equations in particular apply to the non-exact terms of the trace-torsion  $Q$ , as we shall see in this article. But, from the point of view of physics, there is a transformation between a passive time registered by the observer to a different quality of process, which we call time, and is proper to the source. To start with,  $\tau$  is a non-integrable parameter, i.e. it is path-dependent [6], and thus it has to do with non-conservative processes. Thus the equations of electromagnetism while being mathematically equivalent in the Euclidean and Minkowski space, in the former case they have an additional term which is dissipative (and describes the radiation reaction) appearing in the wave equations of the electric and magnetic terms; this longitudinal term is proportional to the inner product of the velocity with the acceleration. In this setting, a classical theory for the electron without divergences is achieved. It was further proved that for a closed system of particles, a global inertial frame and unique invariant global time parameter for all observers is defined in ref. [6]. Thus  $\tau$  which is the time-evolution parameter of the diffusion process (and in the general space and time manifold  $M$  case is not to be confused with the time variable  $t$  of General Relativity <sup>5</sup>) may be related with the time variable introduced by Stueckelberg (and then introduced in quantum field theory), further elaborated by Piron and Horwitz and in several works by Horwitz and coworkers [8], Fanchi [9], Trump and Schieve [10], Pavšic [44], and in the context of a Schroedinger spacetime operator, by Kyprianidis [11], Collins and Fanchi [12] and the present author

---

<sup>5</sup>David Bohm proposed in a paper that appeared in [www.duversity.com](http://www.duversity.com), and presently inaccessible (yet, this discussion can be found in elaborate form in the book, *The Bohm-Bennett Correspondence 1962-64*, DuVersity, 1997), that time was three-fold: time of the source, time of the observer and time of repetition, which was called *hyparxis* by J.G. Bennett.

[2]<sup>6</sup>. Thus, the modification from the passive observer's time to the Euclidean time of the source allows to define simultaneity, while from the physical point of view, it has the meaning of a dissipative process being ascribed to the source. So, we are very far from the trivial passive linear time variable which was incorporated by the Minkowski metric substituted here by a non-integrable function which allows to establish the universality of the observer itself. The fact that the evidence of the time variable which is no longer a mere registration by the observer, is the dissipative process associated to this transformation from the Minkowski space to the Euclidean one is remarkable. If one would downplay the sheer subsistence of Special Relativity with regards to the existence of the aether, if proven to exist, the role of geometries to describe physical processes is enhanced precisely if the Brownian motions described above are the very essence of this aether.

There has been in the last fifty years a number of experiments, mostly carried out in the former Soviet Union by Kozyrev, that have shown the existence of another role for time that the mere relational linear variable that we have inherited from Newtonian mechanics, and that in Special Relativity has been incorporated to the Minkowski metric. In these experiments<sup>7</sup> the role of time appears precisely in terms of dissipative processes and it is evidenced through a field which cannot be shielded and propagates with an estimated velocity of  $10^9 c$  [19]. Kozyrev interpreted his experiments as a proof of the reality of Minkowski space [20]. From the so called causal mechanics due to Kozyrev [13], Levich [22] and M.M. Lavrentiev [21], it follows that asymmetrical (irreversible) time is an active substance, through which the transaction of distant dissipative processes of any nature can take place, being this transaction not only universal in nature, but also running both with retardation and advancement. The proposal of this formative character of time was forwarded not from an abstract quest, but from the need for solving astronomical and astrophysical problems. Kozyrev rejected the idea that the source for the stars energy were fusion reactions [13]<sup>8</sup>, and proposed instead that a substantial active time was related to this [20]. In fact, recent measurements of the Sun, seem to confirm Kozyrev's rejection to the present theory [28]. In this regard, the transactional interpretation of quantum mechanics was proposed as a possible explanation, and as a second perspective, the existence of nonlocal correlations in the strong macroscopic limit. This was applied to the forecast of geomagnetic and solar processes, with very good approximation with the actual processes that came to being after 123 days of observations [23]. In Kozyrev's theory, the active time parameter is

---

<sup>6</sup>Furthermore, the relativistic theory with the  $\tau$  parameter predicts the interference in time of the wave function (see Horwitz and Rabin [45] which has been recently been verified experimentally [46]. We shall discuss further below a series of experiments carried out by Kozyrev and followers, where time appear as having an active role.

<sup>7</sup>A number of these experiments have been repeated recently by Kaivarainen [69].

<sup>8</sup>Kozyrev was a reknown astronomer of his time, he predicted the volcano eruptions that were observed in the Moon in the late fifties.

realized through angular momentum, and thus it can be naturally be associated with a completely skewsymmetric torsion tensor. In the presentation of the relation between the Schroedinger equation, torsion fields and Brownian motions, we shall see that the actual irreversible time invariant Brownian motion of the process that can be linked with the RCW connection with trace-torsion given by electromagnetic potential and the exact logarithmic differential of the distribution density of the Brownian motion, this density is formed by interpolation between the initial and final distributions of the density, which by the way, form the Schroedinger wave function. In this perspective, non-relativistic quantum mechanics which is designed in terms of the time variable which coincides with the time-universal parameter, has the same features that these remarkable processes observed by Kozyrev and followers, it incorporates the past and the future into its setting. While being formally time-symmetric, the Schroedinger equation admits a realization in terms of the future evolving Brownian process built from a RCW connection in which the Schroedinger field is part of its drift through the gradient of its logarithm. As we have seen already, we can take the Hodge dual of the trace-torsion, say, the one that through metric conjugation yields the drift of the Brownian motion associated to the wave function of the Universe, and thus obtain a pseudo-three-form that may be associated with the angular momentum field characteristic of the experiments carried out by Kozyrev. A different approach to explain the Kozyrev phenomenae, but which may be related to the present one, has been developed in remarkable unified theory of physics, biology and consciousness by Kaivarainen in terms of the so called bivacuum structures; for the explanation of the Kozyrev phenomenae, the so called spin guide fields play a fundamental role [69]. In our approach, it is the universal Brownian motions linked to the wave function of the Universe, and the Hodge dual of the trace-torsion of these diffusions, which would produce the same effect that the spin guide fields due to Kaivarainen.

## 4 THE HODGE DECOMPOSITION OF THE TRACE-TORSION FIELD

To obtain the most general form of the RCW laplacian in the non-degenerate case, we only need to know the most general decomposition of 1-forms. To start with, in this section, we have a smooth orientable  $n$ -manifold  $M$  provided with a Riemannian metric  $g$ . We consider as above, the Hilbert space given by the completion of the pre-Hilbert space of square-integrable smooth differential forms of degree  $k$  ( $0 \leq k \leq n$ ) on  $M$ , with respect to the Riemannian volume  $\text{vol}_g$ , which

we denote as  $L^2(\sec(\Lambda^k(T^*M)))$ . We shall focus on the decomposition of 1-forms, so let  $\omega \in L^2(\sec(T^*M))$ ; then we have the Hilbert space decomposition

$$\omega = df + A_{\text{coex}} + A_{\text{harm}}, \quad (16)$$

where  $f$  is a smooth real valued function on  $M$ ,  $A_{\text{coex}}$  is a smooth coexact 1-form, i.e. there exists a smooth 2-form,  $\beta$  such that  $\delta\beta_2 = A_{\text{coex}}$ <sup>9</sup>, so that  $A_{\text{coex}}$  is coclosed, i.e.

$$\delta A_{\text{coex}} = \delta(\delta\beta_2) = 0, \quad (17)$$

and  $A_{\text{harm}}$  is a closed and coclosed smooth 1-form, then

$$\delta A_{\text{harm}} = 0, dA_{\text{harm}} = 0, \quad (18)$$

or equivalently,  $A_{\text{harm}}$  is harmonic, i.e.

$$\Delta_1 A_{\text{harm}} \equiv \text{trace}(\nabla^g)^2 A_{\text{harm}} - R_{\beta}^{\alpha}(g)(A_{\text{harm}})_{\alpha} \gamma^{\alpha} = 0, \quad (19)$$

with  $R_{\beta}^{\alpha}(g) = R_{\mu\alpha}^{\mu\beta}(g)$  the Ricci metric curvature tensor. Eq. (16) is the sourceless Maxwell-de Rham equation. An extremely important fact is that this is a Hilbert space decomposition, so that it has unique terms, which are furthermore orthogonal in Hilbert space, i.e.

$$((df, A_{\text{coex}})) = 0, ((df, A_{\text{harm}})) = 0, ((A_{\text{coex}}, A_{\text{harm}})) = 0, \quad (20)$$

so that the decomposition of 1-forms (as we said before, this is also valid for  $k$ -forms, with the difference that  $f$  is a  $k-1$ -form,  $\beta_2$  is really a  $k+1$ -form and  $A_{\text{harm}}$  is a  $k$ -form) has unique terms, and a fortiori, this is also valid for the Cartan-Weyl 1-form. We have proved that  $A_{\text{coex}}$  and  $A_{\text{harm}}$  are further linked with Maxwell's equations, both for Riemannian and Lorentzian metrics. For the stationary state which we shall describe in the next section, they lead to the equivalence of the Maxwell equation and the relativistic quantum mechanics equation of Dirac-Hestenes in a Clifford bundle setting [2,49] whenever the coclosed (Hertz potential) term and the Aharonov-Bohm harmonic term are both dependent on all the 4D variables while they are infinitesimal rotations defined on the spin-plane.<sup>10</sup> Further, in regards to the above mentioned classical theory of the electron due to Gill, Zachary and Lindsay [6], the validity

<sup>9</sup>Here  $\delta$  denotes the codifferential operator, the adjoint of  $d$ , introduced above.

<sup>10</sup>The problem of equivalence of the Maxwell and Dirac-Hestenes equations has been presented in a general framework in Rodrigues and Capelas de Oliveira [77]. In that work, torsion appears as a mathematical entity in terms of which the whole theory is constructed, yet is presented as unrelated to any recognizable physical field and particularly having no relation with Brownian motions; furthermore, the Hertz potential which is in our formalism is related to the coclosed term, has a fundamental role but is unrelated to torsion, and it is claimed that electromagnetism is a separate phenomena to gravitation, while the present approach following [2] claims the opposite. Furthermore, the equivalence between these equations is established for the exact term of the trace-torsion one-form only [79], while in [2] and [49] it is proved for the general case for  $Q$ , not restricted to the exact term as described above. The equivalence between these equations in a biquaternionic setting has been established by Yefremov [71].

of this decomposition in a Riemannian metric, say , Euclidean space, points to the validity of having this theory of Brownian motion formulated in a non-degenerate (albeit trivial) space-time: these electromagnetic potential terms can be associated with a classical electron which does not require a quantum treatment and allows the introduction of a global time parameter. Furthermore, by studying the topological dimension of the trace-torsion, i.e. the irreducible number of minimal dimensions in space and time on which its coefficients are dependent, we can introduce helicity, spinor structures, minimal surfaces associated to them, superconductivity, turbulence and coherent structures, in short, a topological theory of processes, following the studies by R. Kiehn [47]. Thus, in this approach we can introduce spinor structures on looking to the topological features of the trace-torsion.

#### 4.1 The Decomposition Of The Cartan-Weyl Form And The Stationary State

We wish to elaborate further on the decomposition of  $Q$  in the particular state in which the diffusion process generated by  $H_0(g, Q)$  and its extensions to differential forms, in the case  $M$  has a Riemannian metric  $g$ , and has a  $\tau$ -invariant state corresponding to the asymptotic stationary state. Thus, we shall concentrate on the diffusion processes of scalar fields generated by

$$H_0(g, Q) = \frac{1}{2}(\Delta + L_{\hat{Q}}), \text{ with } Q = d\ln\psi^2 + A_{\text{coex}} + A_{\text{harm}}. \quad (21)$$

This is the invariant form of the (forward) Fokker-Planck operator of this theory (and furthermore of the Schroedinger operator when introducing the phase function to the exact term of  $Q$ ). Through this identification, we note that  $\psi$  is the scale field in the Einstein  $\lambda$  transformations from which in the vacuum, the RCW geometry can be obtained ; see [2]. We are interested now in the  $\text{vol}_g$ -adjoint operator defined in  $L^2(\text{sec}(\Lambda^n(T^*M)))$ , which we can think as an operator on densities,  $\phi$ . Thus,

$$H_0(g, Q)^\dagger \phi = \frac{1}{2}(\Delta_g \phi - \text{div}_g(\phi \text{grad} \ln \phi) - \text{div}_g(\phi \hat{A})). \quad (22)$$

The operator described by eq. (20) is the backward Fokker-Planck operator. The transition density  $p^\nabla(\tau, x, y)$  is determined by the fundamental solution (i.e.  $p^\nabla(\tau, x, -) \rightarrow \delta_x(-)$  as  $\tau \rightarrow 0^+$ ) of the equation on the first variable

$$\frac{\partial u}{\partial \tau} = H_0(g, Q)(x)u(\tau, x, -). \quad (23)$$

Then , the diffusion process  $\{x(\tau) : \tau \geq 0\}$ , gives rise to the Markovian semi-group  $\{P_\tau = \exp(\tau H_0(g, Q)) : \tau \geq 0\}$  defined as

$$(P_\tau f)(x) = \int p^\nabla(\tau, x, y) f(y) \text{vol}_g(y). \quad (24)$$

It has a unique  $\tau$ -independant-invariant state described by a probability density  $\rho$  independant of  $\tau$  determined as the fundamental weak solution (in the sense of the theory of generalized functions) of the  $\tau$ -independent Fokker-Planck equation:

$$H_0(g, Q)^\dagger \rho \equiv \frac{1}{2}(-\delta d\rho + \delta(\rho Q)) = 0. \quad (25)$$

Let us determine the corresponding form of  $Q$ , say  $Q_{\text{stat}} = d\ln\psi^2 + A_{\text{stat}}$ . We choose a smooth real function  $U$  defined on  $M$  such that

$$H_0(g, Q_{\text{stat}})^\dagger(e^{-U}) = 0, \quad (26)$$

so that

$$-de^{-U} + e^{-U} Q = \delta(-\delta\Pi + A_{\text{harm}}), \quad (27)$$

for a 2-form  $\Pi$  and harmonic 1-form  $A_{\text{harm}}$ ; thus, if we set the invariant density to be given by  $\rho = e^{-U} \text{vol}_g$ , then

$$Q_{\text{stat}} = d\ln\psi^2 + \frac{A}{\psi^2}, \text{ with } A = -\delta\Pi_2 + A_{\text{harm}}. \quad (28)$$

Now we project  $\frac{A}{\psi^2}$  into the Hilbert-subspaces of coexact and harmonic 1-forms, to complete thus the decomposition of  $Q_{\text{stat}}$  obtaining thus Hertz and Aharonov-Bohm potential 1-forms for the stationary state respectively. Yet these potentials have now a built-in dependence on the invariant distribution, and although they give rise to Maxwell's theory, the interpretation is now different.<sup>11</sup> Indeed, we have an inhomogeneous random media, and these potentials depend on the  $\tau$ -invariant distribution of the media. We have seen in [2] that these potentials appear in the context of the equivalence of the Maxwell sourceless equation on Minkowski space written in terms of a Dirac-Hestenes spinor field, and the non-linear Dirac-Hestenes equation for these fields, albeit in Minkowski space provided with a RCW connection with trace-torsion given by  $Q_{\text{stat}}$ . Yet, we can exploit further the Hodge-decomposition of  $Q_{\text{stat}}$  to manifest the quantum potential as built-in. Indeed, if we multiply it by  $\psi$  and apply  $\partial$ , then we

<sup>11</sup>A word of caution. In principle,  $-\delta\Pi/\rho$  and  $A_{\text{harm}}/\rho$  may not be the coexact and harmonic components of  $A/\rho$  respectively. If this would be the case, then we obtain that  $d\ln\psi$  is  $g^{-1}$ -orthogonal to both  $-\delta\Pi$  and  $A_{\text{harm}}$ ; furthermore  $d\ln\psi \wedge A_{\text{harm}} = 0$ , so furthermore they are collinear. This can only be for null  $A_{\text{harm}}$  or constant  $\rho$ , so that the normalization of the electromagnetic potentials is by a trivial constant. In the first case the invariant state has the sole function of determining the exact term of  $Q$  to be (up to a constant)  $d\ln\psi$ .

get that  $d\ln\psi$ , and the coexact and harmonic terms of  $Q_{\text{stat}}$  decouple in the resultant field equation which turns out to be

$$\Delta_g\psi = [g^{-1}(d\ln\psi, d\ln\psi) - \delta d\ln\psi]\psi, \quad (29)$$

with nonlinear potential  $V := g^{-1}(d\ln\psi, d\ln\psi) - \delta d\ln\psi$ , which has the form of (twice) a relativistic quantum potential extending Bohm's potential in non-relativistic quantum mechanics [51]. We have seen in [2], that from scale-invariance it follows that the quantum potential coincides up to a conformal factor with the metric scalar curvature, as we shall elaborate below.

Finally, we want to recall the essence of the problem of time-invariance of the diffusion processes on the invariant state. In this setting, following the Kolmogorov characterization [70],  $\tau$ -reversibility is verified whenever for any two smooth compact supported functions  $f, h$  defined on  $M$ , we have that

$$\int (H_0(g, Q)f)(x)h(x)\rho(x)\text{vol}_g(x) = \int f(x)(H_0(g, Q)h(x))\rho(x)\text{vol}_g(x) \quad (30)$$

and thus it can be seen that this is the case if and only if  $\delta\Pi$  and  $A_{\text{harm}}$  vanish completely, and thus  $Q = \frac{1}{2}d\ln\rho$ . This will be of importance when studying the problem of the reduction of the wave function when considering the representation of the Laplacian operator, or still, as it have the same eigenstates, the Schroedinger operator on the state-space of quantum mechanics.

## 5 ENERGY FORMS, THE QUANTUM POTENTIAL AND RCW DIFFUSIONS

In this section we shall show that the RCW geometries yield a natural formulation of quantum mechanics on manifolds, as an operator theory on two Hilbert spaces [2]. So, this section and the next, we will discuss basic issues which on the usual setting have been somehow obviated and are far from being obvious. The basic formalism which leads to this is the well known remarkable correspondence explored in flat Euclidean space between the Dirichlet forms of potential theory, Markovian semigroups and their diffusion processes [37][73] and RCW laplacian operators [2], and originates in the canonical commutation relations. In fact, in quantum field theory on curved space-time, the starting point is an energy functional for the field associated to a self-adjoint operator on the Hilbert space determined by the Riemannian volume element [71]. In our theory, this self-adjoint operator will appear to be the conformal transform of the self-adjoint extension of the RCW laplacian as defined on an adequate subspace of the ground-state Hilbert space with a weighted inner product defined by the invariant density . Thus, two Hilbert spaces are needed: the ground-state Hilbert space on which we have a diffusion generated by the RCW laplacian which acts as the Fokker-Planck operator, and the Hilbert space defined by the

Riemannian volume in which this operator transforms into the Schroedinger operator. We shall present below the above mentioned correspondences.

We assume that  $M$  has a Riemannian metric; we assume further that is four-dimensional space-time (and thus, we are in the situation discussed in [2] and references therein) and a diffusion process with stationary state  $\psi^2 \text{vol}_g$  with null electromagnetic terms in eq. (28), generated by  $H_0(g, d\ln\psi^2) = \frac{1}{2}(\Delta_g + \text{grad}\ln\psi^2)$ , a Hamiltonian operator on the Hilbert space  $L^2(\psi^2 \text{vol}_g)$ ; thus, the drift vector field is  $\text{grad}\ln\psi$ . With abuse of notation, let us denote still as  $H_0(g, d\ln\psi^2)$  the Friedrichs self-adjoint extension [21,43] of the infinitesimal generator given in eq. (27) with domain given by  $\mathcal{D}$ , the space of compact supported infinitely differentiable functions on  $M$ ; for related discussions on this extension, we elaborate further in Section VII below). We can now define the inner product

$$(f_1, f_2)^\rho = 1/2 \int g^{-1}(df_1, df_2)\psi^2 \text{vol}_g \quad (31)$$

By integration by parts, we obtain

$$(f_1, f_2)^\rho = -(f_1, H(g, d\ln\psi^2)f_2)^\rho \quad (32)$$

where  $(\cdot, \cdot)^\rho$  denotes the weighted inner product in  $L^2(\psi^2 \text{vol}_g)$ . Let us consider now the closed quadratic form, (the *Dirichlet form*)  $q$  associated to  $(\cdot, \cdot)^\rho$ , i.e.  $q(f) = (f, f)^\rho$ . We see from eq.(32) that there is a unique Hamiltonian operator which generates  $q$ , it is the self-adjoint operator  $-H_0(g, d\ln\psi^2)$ . Since the quadratic form is positive,  $q(f) \geq 0$ , for any  $f \in L^2(\psi^2 \text{vol}_g)$ , then  $H_0(g, d\ln\psi^2)$  is a negative self-adjoint operator on  $L^2(\psi^2 \text{vol}_g)$  and the Markovian semigroup  $\exp(\tau H(g, d\ln\psi^2))$  is defined. Let us see how this construction is related to the usual formulation of Quantum Mechanics in terms of quadratic forms in  $L^2(\text{vol}_g)$ , which in the non- relativistic flat case has been elaborated by several authors [73]. Consider the mapping  $C_\psi : L^2(\psi^2 \text{vol}_g) \rightarrow L^2(\text{vol}_g)$  defined by multiplication by  $\psi$ ; this is the groundstate transformation and defines a conformal isometry between the two Hilbert spaces. This map takes  $C_0^\infty(M)$  into itself. For any  $f$  in  $C_0^\infty(M)$  we have

$$\begin{aligned} q(\psi^{-1}f) &= (\psi^{-1}f, \psi^{-1}f)^\rho \\ &= 1/2 \int \{g^{-1}(df, df) - 2g^{-1}(df, d\ln\psi)f + g^{-1}(d\ln\psi, d\ln\psi)f^2\} \text{vol}_g \\ &= 1/2 \int \{g^{-1}(df, df) + (\text{div}_g(b)f^2 + g(b, b)f^2)\} \text{vol}_g \\ &= \int f \{-\frac{1}{2}\Delta_g + V\} f \text{vol}_g = (f, Hf)_{L^2(\text{vol}_g)} \end{aligned} \quad (33)$$

where we denoted  $b = \text{grad}\ln\psi$  which is the drift vector field of the process generated by  $H_0(g, d\ln\psi^2)$  since by eqs. (47) and (55) this is  $\frac{1}{2}\text{grad}\ln\psi^2$  and

$$H = C_\psi \circ H(g, d\ln\psi^2) \circ C_\psi^{-1} = -1/2\Delta_g + V, \quad (34)$$



where in the weak sense,

$$V = \frac{1}{2}(\operatorname{div}_g b + g(b, b)) = \frac{\Delta_g \psi}{2\psi}, \quad (35)$$

is the *relativistic quantum potential*; here, in distinction with Bohm's quantum potential in non-relativistic Quantum Mechanics [68] (which is retrieved in the case of  $n = 3$  and  $g$  the Euclidean metric), it depends on both the space and time- $t$  coordinates. Then, we have proved that  $-H(g, d\ln\psi^2)$  is unitarily equivalent to the Hamiltonian operator  $H := -\frac{1}{2}\Delta_g + V$  defined on  $L^2(\operatorname{vol}_g)$  and  $\psi$  is a generalized groundstate eigenfunction of  $H$  with 0 eigenvalue. The non-linear dependence of  $V$  on the invariant density introduced by  $\psi$  introduces non-local correlations on the quantum system. We shall see below that this dependence of  $V$  on  $\psi$  is removed due to conformal invariance. This will establish that the Schrodinger operator  $H$  has for quantum potential one-twelfth of the Riemannian scalar metric and thus  $H$  coincides with the Riemannian conformal invariant wave operator considered in quantum gravity in curved spaces [71]. We shall now elaborate on these aspects.

## 6 THE MEAN CURVATURE EXTREMAL PRINCIPLE

Since at the level of constitutive equations for  $Q$ , the electromagnetic potentials decouple from the  $\psi$ -field (see the discussion that lead to eq. (29)) we can study independently the field equations from which the RCW connection with exact  $Q$  can be derived. We shall assume that  $n = 4$ . We start with a general Riemann-Cartan connection  $(\Gamma_\alpha^{ab})$ , (where Greek letters denote space-time indices as until now, and Latin letters denote anholonomic indices), and we introduce its scalar curvature

$$R(\Gamma) = e_a^\alpha e_b^\beta R_{\alpha\beta}{}^{ab}, \quad (36)$$

where the  $e_a^\alpha$  is a field of invertible tetrads with  $g_{\alpha\beta} = \delta_{ab} e_a^\alpha e_b^\beta$ , with  $\delta_{ab}$  the Euclidean metric<sup>12</sup>, and  $R_{\alpha\beta}{}^{ab}$  is the curvature tensor of  $(\Gamma_\alpha^{ab})$  [37]. Now we recall the Einstein's  $\lambda$  transformations of above (here  $\rho$  will be substituted by a scalar

<sup>12</sup>All the following definitions of the  $\lambda$  transformations and the ensuing field equations are valid as well if we take here the Minkowski metric; since we do not know whether our construction of a relativistic Brownian motion carries from the Minkowski space to general Lorentzian metrics, in this section we shall keep the metric to be positive-definite for which we take the initial metric to be Euclidean. Brownian motions the Schwarzsild metric has been recently constructed on the unit tangent manifold (see J. Franchi and Y. Le Jan, Relativistic Diffusions, arXiv:math.PR/0403499). The relation of this construction, with the Lorentz-invariant Brownian motions on Minkowski space presented in [5, 2] and the present article is unknown.

field  $\phi$ ): Let  $\phi$  be a real function on  $M$ . Then  $\lambda(\Gamma_{\alpha b}^a) := \Gamma_{\alpha b}^a$ , and  $\lambda(e_a^\alpha) := \phi^{-1}e_a^\alpha$  so that  $\lambda(g_{\alpha\beta}) = \phi^2g^{\alpha\beta}$  and then the scalar curvature transforms as  $\lambda(R(\Gamma)) = \phi^{-2}R(\Gamma)$ , and finally  $\text{vol}_{\lambda(g)} = \phi^4\text{vol}_g$ . Since the scalar fields  $\psi$  transform as  $\lambda(\psi) = \phi^{-1}\psi$ , we get that the functional

$$A(\Gamma, \psi, g) = \int R(\Gamma)\psi^2\text{vol}_g, \quad (37)$$

is invariant by the set of  $\lambda$  transformations, i.e.:  $A(\lambda(\Gamma), \lambda(\psi), \lambda(g)) = A(\Gamma, \psi, g)$ . Notice that if from the field equations we obtain that  $\psi^2\text{vol}_g$  can be identified with the unique invariant density of the diffusion process generated by  $H_0(g, d\ln \psi^2)$ , then (37) is the *mean Riemann-Cartan scalar curvature*. Taking variations with respect to  $g$  we obtain that

$$R_{\alpha\beta}(\Gamma) - 1/2g_{\alpha\beta}R(\Gamma) = 0, \quad (38)$$

i.e. the Einstein-Cartan equations for  $\Gamma$  in the vacuum, while by taking variations with respect to  $\Gamma_{\alpha\beta}^\gamma$ , we obtain that torsion tensor is a particular case of the one we derive from the anticommutator of eq. (9), since we have

$$T_{\alpha\beta}^\gamma = \delta_\alpha^\gamma \partial_\beta \ln \psi - \delta_\beta^\gamma \partial_\alpha \ln \psi, \quad (39)$$

so that, up to factor of 3 which we shall absorb so we shall take  $Q = d\ln \psi$  and thus the field equations have yielded a RCW structure with exact  $Q$ . Taking variations with respect to  $\psi$  we get the teleparallelism:  $R(\Gamma) = 0$ ; replacing eq. (39) in eq. (38) we get the field for the Einstein metric tensor  $G_{\alpha\beta}(g) = R_{\alpha\beta}(g) - \frac{1}{2}R(g)$ :

$$G_{\alpha\beta}(g) = -\frac{6}{\psi^2}\partial_\alpha\psi \partial_\beta\psi - 1/2g_{\alpha\beta}\partial_\gamma\psi\partial^\gamma\psi - \frac{1}{6}(\nabla_\alpha\nabla_\beta\psi^2 - g_{\alpha\beta}\Delta_g\psi^2), \quad (40)$$

where in the r.h.s. we identify (up to a factor) minus the improved energy-momentum density of the scalar field in renormalizable gauge theories. Now, by taking the trace in this equation we finally get

$$(\Delta_g - \frac{1}{6}R(g))\psi = 0, \quad (41)$$

so that  $\psi$  is a generalized groundstate of the conformal invariant wave operator defined on  $L^2(\text{vol}_g)$ . Note that from eqs. (34, 35, 41) we conclude that the quantum potential is  $\frac{1}{12}R(g)$  which *does not* depend on the scalar field  $\psi$  at all. Therefore, the correlations on the quantum system under Brownian motion with drift given by  $b = \text{grad} \ln \psi$  are mediated by the metric scalar curvature (which, of course, does not depend on  $\psi$  any more; this is the form invariance of the quantum potential [3])! Otherwise stated and in view of the relation between the noise tensor and the Riemannian metric (see the discussion after

eq. (15)), when we have an anisotropic noise tensor we have constructed a non-trivial metric and quantum non-local correlations which are due to the metric scalar curvature.

Solving the conformal invariant wave equation with Dirichlet regularity conditions on the closure of an open neighborhood of  $M$  [27], we obtain a conformally conjugate Dirichlet form whose associated Hamiltonian operator is  $-H_0(g, d\ln \psi^2)$ , with  $\psi$  a solution of eq. (41) and thus the Markovian semigroup determined by it can be reconstructed by reversing the steps in the previous Section. We shall finally establish the relation between the heat kernel  $p_{\text{conf}}(\tau, x, y)$  of the Markovian semigroup  $\exp(\frac{\tau}{2}H)$  and the heat kernel  $p_\psi(\tau, x, y)$  of the RCW semigroup. We have

$$\begin{aligned} \exp(\tau H_0(g, d\ln \psi^2))f(x) &= \psi^{-1}(x)\exp(\frac{\tau}{2}H)(\psi f)(x) \\ &= \int \psi^{-1}(x)p_{\text{conf}}(\tau, x, y)\phi(y)f(y)\text{vol}_g(y) \quad (42) \end{aligned}$$

so that we conclude that

$$p_\psi(\tau, x, y) = \psi^{-1}(x)\psi(y)p_{\text{conf}}(\tau, x, y). \quad (43)$$

Thus, we have linked the kernels of the quantization in the two Hilbert spaces, the groundstate Hilbert space  $L^2(\psi^2\text{vol}_g)$ , and  $L^2(\text{vol}_g)$ . The former corresponds to the RCW geometry, while the latter is the usual Hilbert space for the quantization of the kinetic energy of a spinless massive free-falling test-particle, in terms of the Riemannian invariants of the manifold  $M$  described in terms of  $g$ ! We remark that the introduction of both spaces and the unitary transformation between them, has allowed us to identify the quantum potential, while working only in the usual Hilbert space would not have allowed for this identification; finally, the scalar curvature term so much discussed has been found to be a resultant of the  $\lambda$  invariance of the theory, and not the resultant of technicalities in computing the propagators; as discussed already in [2], this theory has no ordering problem [44]. Thus, in the  $L^2(\text{vol}_g)$  space we have found the Hamiltonian operator considered by B.de Witt, and reencountered by several researchers in quantum field theory in Riemannian geometries through the short- $\tau$  expansion of  $p_{\text{conf}}(\tau, x, x)$  [71] in geometrical and topological invariants, and for the path integral representations for Fokker-Planck operators [72], which as we already saw, when  $g$  is Riemannian, are precisely of the form  $H_0(g, Q)$ . Yet, our result is in disagreement with the path integral representation of the classical kinetic energy of a massive particle in a Riemann-Cartan geometry due to Kleinert, in which he obtains *twice* the quantum potential (see, chap. X, [?])<sup>13</sup>.

---

<sup>13</sup>For a discussion on the work of Kleinert and the role of autoparallels we suggest the reader to return to Remarks 1 and footnote no. 8 before Section 5 of [1].

## 7 RCW DIFFUSIONS AND NON-RELATIVISTIC QUANTUM MECHANICS

From the previous section we know that for the stationary state defined by  $\rho$  the laplacian defined by a RCW connection is symmetric with respect to the measure defined by  $\rho$  if and only if the trace-torsion is given by  $Q = \frac{1}{2}d\ln\rho$ . Futhermore, it is a non- positive-definite operator since for any functions in the space  $\mathcal{D}$  of compact supported functions  $u$  and  $v$  defined on  $M$  we have the Green identity

$$\int_M u(H_0(g, Q)v)\rho\text{vol}_g = - \int_M g(\nabla u, \nabla v)\rho\text{vol}_g = \int_M v(H_0(g, Q)u)\rho\text{vol}_g. \quad (44)$$

We wish to see if there exists a self-adjoint extension of  $H_0(g, Q)|_{\mathcal{D}}$  in the space  $L^2 = L^2(M, \rho)$  of square-integrable functions with respect to the density  $\rho\text{vol}_g$ . Consider the space  $W^1(M, \rho) = \{f : M \rightarrow C, f \in L^2, \nabla f \in L^2\}$  where we mean by  $\nabla f$  the distributional gradient. We can turn this space into a complex Hilbert space by working with complex-valued functions provided with the inner product

$$(u, v)_{W^1} = \int_M u\bar{v}\rho\text{vol}_g + \int_M g(\nabla u, \nabla \bar{v})\rho\text{vol}_g. \quad (45)$$

Let  $W_0^1$  be the closure of  $\mathcal{D}$  in  $W^1$ ; define  $W_0^2 = W_0^2(M, \rho) = \{f \in W_0^1 / H_0(g, d\ln\rho)f \in L^2\}$  where the latter action of the operator is meant in the distributional sense. Since  $\mathcal{D} \subset W_0^2$ , then  $H_0(g, d\ln\rho)|_{W_0^1}$  is an extension of  $H_0(g, d\ln\rho)|_{\mathcal{D}}$ . Therefore  $-H_0(g, d\ln\rho)$  is a positive-definite self-adjoint extension defined in  $L^2$ . Furthermore, if  $M$  is geodesically complete, then  $H_0(g, d\ln\rho)|_{W_0^2}$  is a unique self-adjoint extension of  $H(g, d\ln\rho)|_{\mathcal{D}}$ .<sup>14</sup>

Consider next the Dirichlet problem for  $H_0(g, Q)|_{W_0^2}$  on a relatively compact non-empty set  $\Omega$  in  $M$ , so that

$$\begin{cases} H_0(g, Q)u + \lambda u = 0 & \text{in } \Omega, \\ u = 0 & \text{in } \partial\Omega, \end{cases}$$

where  $\lambda$  is constant. This can be considered in the weak sense: We look for a non-zero function  $u \in W_0^1(\Omega, \rho)$  such that for all  $v \in W_0^1(\Omega, \rho)$ ,

$$- \int_{\Omega} g(\nabla u, \nabla v)\rho\text{vol}_g + \lambda \int_{\Omega} uv\rho\text{vol}_g = 0. \quad (46)$$

---

<sup>14</sup>A short approach to the proof. The first part is the fact that the space  $W_0^1$  is a Hilbert space so that the quadratic form  $\mathcal{E}(u, v) = \int_M g(\nabla u, \nabla v)\rho\text{vol}_g$  with the domain  $W_0^1$  is closed in  $L^2$ . Therefore, it has the generator, which is self-adjoint with domain  $W_0^2$  and hence, is the Friedrich extension of  $H(g, \frac{1}{2}d\ln\rho)|_{\mathcal{D}}$ ; see [36][37].

It is easy to prove that  $u$  is a solution of this problem if and only if  $u \in W_0^2(\Omega, \rho)$  and  $H_0(g, Q)u + \lambda u = 0$ . Considering then the manifold  $\Omega$  provided with the density  $\rho$ , we conclude that the eigenvalues of the weak Dirichlet problem in  $\Omega$  are exactly the eigenvalues of the self-adjoint operator  $-H(g, Q)|_{W_0^2(\Omega, \rho)}$  in  $L^2(\Omega, \rho)$ .

We have a theorem due to Rosenberg [37]: For any non-empty relatively compact open set  $\Omega \subset M$ , the spectrum of  $-H(g, Q)|_{W_0^2(\Omega, \rho)}$  is discrete and consists of a sequence  $\{\lambda_k(\Omega)\}_{k=1}^\infty$  of non-negative real numbers such that  $\lambda_k(\Omega) \rightarrow \infty$  as  $k \rightarrow \infty$ . If in addition  $M - \bar{\Omega}$  is non-empty, then  $\lambda_1(\Omega) > 0$ .

Assuming that the eigenvalues are counted with multiplicity, we have the Weyl asymptotic formula

$$\lambda_k(\Omega) \approx c_n \left( \frac{k}{\int_\Omega \rho \text{vol}_g} \right)^{\frac{2}{n}}, \text{ as } k \rightarrow \infty, \quad (47)$$

where  $n = \dim(M)$  and the constant  $c_n > 0$  is the same as in  $R^n$ .

If  $M$  is compact, then we have  $\lambda_1(M) = 0$ , because the function  $f = \text{constant}$  is an eigenfunction. Since  $H_0(g, Q)f = 0$  implies  $f = 0$  (we are assuming that  $M$  is connected), the multiplicity of the bottom eigenvalue is 1 and then  $\lambda_2(M)$  is strictly positive. In any case, the lowest eigenvalue of  $-H_0(g, Q)|_{W_0^2(M, \rho)}$  can be determined as follows.

Furthermore, we have a theorem (Rayleigh Principle) for the minimal eigenvalue [37]: For a manifold  $M$  provided with a density  $\rho \text{vol}_g$ ,

$$\lambda_{\min}(M) = \inf_{f \in \mathcal{T}-0} \frac{\int_M |\nabla f|^2 \rho \text{vol}_g}{\int_M f^2 \rho \text{vol}_g}, \quad (48)$$

where  $\mathcal{T}$  is any class of test functions such that  $\mathcal{D} \subset \mathcal{T} \subset W_0^1$ .

Proof: It follows from the variational principle for the operator  $-H_0(g, Q)|_{W_0^2}$  and by the Green formula, that

$$\lambda_{\min}(M) = \inf_{f \in W_0^2} \frac{-\int_M (H_0(g, Q)f, f) \text{vol}_g}{\|f\|_{L^2}^2} \quad (49)$$

$$= \inf_{f \in W_0^2-0} \frac{\int_M |\nabla f|^2 \rho \text{vol}_g}{\|f\|_{L^2}^2}, \quad (50)$$

and by observing that  $\mathcal{D} \subset W_0^2 \subset W_0^1$  and  $\mathcal{D}$  is dense in  $W_0^1$ .

## 8 GEOMETRIC QUANTUM-MECHANICS ON STATE-SPACE

We consider a complex separable Hilbert space  $\mathcal{H}$  and a self-adjoint operator  $H$  defined on  $\mathcal{H}$ . The time development of quantum systems is given by the one-parameter group  $\{e^{-itH}, t \in R\}$  of unitary operators. A pure quantum state

$\psi \in \mathcal{H}, \|\psi\| = 1$ , develops according to

$$\psi_t = e^{-itH}\psi \quad (51)$$

which can be reformulated in terms of the Schroedinger equation

$$\frac{\partial\psi_t}{\partial t} = -iH\psi_t. \quad (52)$$

Still, pure quantum states are described by equivalence classes  $[\psi]$  of unit vectors  $\psi \in \mathcal{H}$ , where two vectors are equivalent if they differ by a complex phase factor. Then, the time development of the state  $[\psi]$  is given by

$$\Phi_t([\psi]) = [e^{-iHt}\psi]. \quad (53)$$

While eqs. (51) and (52) are equivalent, this is no longer the case of eqs. (52) (53), since  $\psi_t$  can contain a complex time dependant factor. The proper setting for quantum mechanical evolution in terms of the Schroedinger equation requires to take in account this indeterminate factor. So the state space is the projective Hilbert space  $\mathcal{P}(\mathcal{H})$ , and the time evolution of quantum systems are curves on this space of the form  $\gamma(t) = \Phi_t([\psi]) = [e^{-iHt}\psi]$ .

There are two ways in which one can construct from a heat semigroup defined by a RCW diffusion process its quantum Schroedinger representation. In this case, the hamiltonian operator is  $H(g, Q)$  associated to a RCW connection with  $Q = \frac{1}{2}d\ln\rho$  and the corresponding unitary group  $[e^{-i\tau H(g, Q)}]$  defined on the natural complex extension of a real Hilbert space as we have taken in the previous section, corresponds to the so-called Euclidean analytical Schroedinger representation for the diffusion semigroup defined by this space-time structure, yet with some differences we would like to remark. Firstly, there is a freedom upon the choice of the time, it can be  $\tau$  for a relativistic theory in which  $g$  can depend on  $t$  as well as  $Q$  and our space-time manifold is a 4-dimensional manifold,  $M$ , or, we can write down a non-relativistic theory, for which  $\tau$  and  $t$  coincide [23] and space-time is  $R \times M$  where  $M$  is a 3-manifold, but still we have in this foliated manifold a Riemannian metric which may depend on  $t$  as well as the trace-torsion  $Q$ ; in any case, due to the fact that in Quantum Mechanics observables are self-adjoint operator (real eigenvalues) we have to restrict  $Q$  to be exact of the form  $Q = \frac{1}{2}d\ln\rho$  because the inclusion of the electromagnetic terms, following the Kolmogorov characterization of  $\tau$ -symmetric diffusion processes, produces  $H(g, Q)$  for general  $Q$  to be a non-symmetric operator in  $L^2(M, \rho)$ , so we cannot introduce the self-adjoint extension of it. The other possibility is to develop a covariant formulation of non-relativistic Quantum Mechanics in  $R \times M$  in which we transform the diffusion processes into the Schroedinger equation without applying the Euclidean time scheme, but in this case  $Q$  does not necessarily restrict to the exact differential term, including thus the electromagnetic terms and the Schroedinger operator is associated to the RCW laplacian in an indirect way in which will adquire the form  $\Delta_g + V$ , where

$V$  is a potential which can eventually depend on the wave function or not, which for appropriate classes of potentials  $V$  can result in a self-adjoint operator; see page 34 in Schechter [39]. Both theories we know already how to formulate as an infinite-dimensional Hamiltonian system (in the sense of classical mechanics), as long as the spectrum of  $H(g, Q)$  is discrete, which in the case of  $Q$  restricted to be exact, is already the case as discussed above. In this article, we shall present both alternatives. Finally, having set the geometric approach to quantum mechanics in Hilbert space, we can further study the so-called stochastic extension of the Schroedinger equation, which amounts to write the s.d.e. which extend the Hamiltonian flow with a noise term which drives the system to a particular eigenstate, providing thus for the reduction of the wave function.

## 9 THE STATE-SPACE QUANTUM GEOMETRIES, BROWNIAN MOTIONS AND THE REDUCTION OF THE WAVE FUNCTION

The notion of a geometric theory of quantum mechanics has been in most of the works associated with the idea of placing in a purely geometrical context the operator formalism of quantum mechanics and describing the processes of observation in terms of geometrical distance in state-space; the other approach that can be named identically as quantum geometry, is the present approach that is valid for both configuration manifolds and state-space manifolds. The former geometrical approach has led to formulate non-relativistic quantum mechanics as a theory of Kahler manifolds, and to breach the gap with classical mechanics which as well known, is formulated in terms of symplectic flows, and in particular, those associated with a Hamiltonian function independent of time. The Hamiltonian function that generates the Schroedinger flow is non other than the expectation value function defined on state-space of the quantum Hamiltonian operator. In this so called quantum geometry (see [15,16,18] and references therein), the Schroedinger equation is a symplectic flow in state-space, given by a complex projective manifold, provided with the Fubini-Study metric, with its naturally associated symplectic and Kahlerian structures. Furthermore, by considering random perturbations of this symplectic flow to account for the role of the environment in the quantum system, the reduction of the wave-function has been described in terms of stochastic processes on the quantum geometry on state-space [27,28]. This approach to the so-called *open* Schroedinger equation has been elaborated as an emergent theory of a background statistical theory of unitary matrices. In none of this approaches to the open Schroedinger equation, no relation was established with the fact that there is a quantum geometry in space-time and its association with Brownian motions. Thus, this chapter aims to present a very short account of the fact that we can describe the stochas-

tic processes in state-space that describe the reduction of the wave-function in terms of the same stochastic-geometrical structures of Riemann-Cartan, and that the Schroedinger symplectic flow defined by the expectation value of the Hamiltonian operator is (up to a modification which drives the measurement process to a specific eigenstate) the natural choice for the drift. In particular, one can start with a stochastic differential equation, consider the connection on space-time defined by it and its differential generator which is the Laplacian operator of this geometry, and study the reduction of the wave function of the quantum evolution of this space-time operator. In this sense, the role of space-time structures in producing the reduction of the wave function. So in this case, we have a two layer structure of RCW type, one related to the diffusion process in space-time and the second one, with the diffusion process in state-space that follows when studying the spectra of the RCW laplacian, or can be carried out independently for an arbitrary quantum system described by its Hamiltonian operator. In the following we shall present both quantum geometries in a single setting. In the following we follow our discussion in [77].

Let us assume we have a Hilbert space with finite dimension  $n + 1$  so we are dealing with  $M$  being  $CP(n)$ , the complex projective space of dimension  $n$ , the space of rays of Quantum Mechanics, although the more general infinite-dimensional case is also possible. In fact, this space not only carries a Riemannian metric, the Fubini-Study (FS) metric, which we denote as  $g$  but also a symplectic two-form  $\Omega$  and still an almost complex structure provided by an endomorphism  $J_z : T_z M \rightarrow T_z M$  such that  $J^2 = -I$  and  $g(u, Jv) = \Omega(u, v)$  for all  $u, v \in CP(n), z \in M$ . Indeed, denote the hermitean product of the the  $n + 1$ -dimensional Hilbert space of the quantum system as  $\langle u, v \rangle = g(u, v) + i\Omega(u, v)$  where  $g(u, v) = \Re \langle u, v \rangle$  and  $\Omega(u, v) = \Im \langle u, v \rangle$ , and  $g(u, v) = g(Ju, Jv)$ . Furthermore  $J$  is compatible with  $g$ , i.e.  $\nabla J = 0$ , where  $\nabla$  is the Levi-Civita covariant derivative. Thus,  $M$  provided with  $(g, \Omega, J)$  becomes a Kahler manifold. For a self-adjoint Hamiltonian operator  $H$  defined on  $CP(n)$ , we define the quantum-expectation value function  $(H) : CP(n) \rightarrow R$  by  $(H)(u) = \frac{\langle u, Hu \rangle}{\langle u, u \rangle}$ . In this section we shall then restrict ourselves to the Euclidean technique and take  $H = H(g, Q)$  the self-adjoint operator defined in a finite-dimensional complex subspace of the Hilbert space  $\mathcal{H} = W_0^2$ ; this amounts to fixing a cut-off which one can fix in accordance with the estimates given above <sup>15</sup>. We denote the general state vector by  $|z\rangle$  with  $z$  standing for the complex projections  $z^0, \dots, z^n$  of  $|z\rangle$  on an arbitrary fixed basis. Thus,  $(H)(|z\rangle) = \frac{\langle z|H|z\rangle}{\langle z, z\rangle} = \frac{\bar{z}^\alpha H_{\alpha\beta} z^\beta}{\bar{z}^\delta z^\delta}$ . Since  $(H)$  is homogeneous of degree zero on both  $z^\alpha, \bar{z}^\alpha$  we define the new complex coordinates  $t^j = \frac{z^j}{z^0}$  and  $\bar{t}^j = \frac{\bar{z}^j}{\bar{z}^0}, j = 1, \dots, n$ , which are well defined whenever  $z^0 \neq 0$ . The

<sup>15</sup> Actually, we can take for this operator, the self-adjoint extension of  $H(g, Q)$  for  $Q = d\ln\rho^{\frac{1}{2}}$  now acting on  $CP(\infty)$  [8]; for the purpose of keeping this article to some length, we prefer not to deal with this more general case which does not imply major differences with the finite-dimensional case.



real manifold structure of  $CP(n)$  is defined by taking the coordinate system  $(x^a), a = 1, \dots, 2n$  with  $x^1 = \Re t^1, x^2 = \Im t^2, \dots, x^{2n-1} = \Re t^{2n-1}, x^{2n} = \Im t^{2n}$ . Thus, the specification of the  $2n$ -vector  $(x^a)$  determines the unique ray containing the unnormalized state  $|z\rangle$ . The FS metric  $g = (g_{\alpha\beta} dz^\alpha \otimes d\bar{z}^\beta)$  with  $g_{\alpha\beta} = 4 \frac{\partial^2}{\partial z^\alpha \partial \bar{z}^\beta} \ln \bar{z}^\gamma z^\gamma$  written on the real manifold is  $g = (g_{ab} dx^a \otimes dx^b)$  with (see S. Adler and L. Horwitz [16])

$$g_{ab} = 4 \frac{[(1 + x^d x^d) \delta_{ab} - (x^a x^b + \omega_{ac} x^c \omega_{bd} x^d)]}{(1 + x^l x^l)^2}, \quad (54)$$

with inverse

$$g^{ab} = \frac{1}{4} (1 + x^l x^l) (\delta_{ab} + x^a x^b + \omega_{ac} x^c \omega_{bd} x^d). \quad (55)$$

where  $\omega_{ab}$  is a skewsymmetric tensor whose only non-vanishing terms are  $\omega_{a=2j-1, b=2j} = 1, \omega_{a=2j, b=2j-1} = -1$ . Furthermore, the complex structure  $J = (J_a^b)$  satisfies  $J_a^b J_b^c = -\delta_a^c$ , and the identities  $J_a^c J_c^d g_{cd} = g_{ab}$  and the symplectic form  $\Omega = \Omega_{ab} dx^a \wedge dx^b$  satisfies  $\Omega_{ab} = g_{bc} J_a^c$  with inverse  $\Omega^{ab} = g^{ac} J_c^b$ . Then (SE) takes the form (we take  $\hbar = 1$ ) of the Hamiltonian flow on  $M$  given by  $\frac{dx}{dt} = 2\Omega(\nabla(H))$ , where  $\nabla^a f = g^{ab} \partial_b f (a = 1, \dots, 2n)$  is the FS gradient of  $f : M \rightarrow R$  [18]. To consider the dynamics of the quantum system under the influence of a measurement, we have to include the random variations due to the measurement. Thus, we extend the hamiltonian flow defined by the function  $(H)$ , by considering the Ito s.d.e. (originally in [15])

$$dx^a = (2\Omega^{ab} \partial_b(H) + \rho^a) dt + \sigma g^{ab} \partial_b(H) dW(t) \quad (56)$$

with  $\rho^a = -\frac{1}{4} \sigma^2 g^{ab} \partial_b V$ , where  $V = g^{ab} \partial_a(H) \partial_b(H) = (H^2) - (H)^2$  is the variance of the Hamiltonian, or still, the squared energy quantum uncertainty. Thus, we have modified the drift with a term which depends on  $\nabla(H)$ , and still there is a noise tensor which is in this case a vector of the form  $\sigma \nabla(H)$ , with  $\sigma$  a constant, and we have a one-dimensional Wiener process ( $i = 1$ ) in eq. (15). Thus, if we start from the s.d.e. (56), the metric that arises from the noise vector turns to be not the original FS metric  $g$ , but the contravariant tensor with components  $\nabla^a(H) \nabla^b(H) = g^{ad} \partial_d(H) g^{be} \partial_e(H)$ , times the factor  $\sigma^2$ , which on setting it to be equal to zero, we get the original SE written in  $CP(n)$ . Furthermore, the trace-torsion one-form  $Q = Q_e dx^e$  has for components the functions  $g_{ae} ((2\Omega^{ab} \partial_b(H) + \rho^a) = 2J_e^b \partial_b(H) - \frac{1}{4} \sigma^2 \partial_e V$ , so that

$$Q = Jd(H) - \frac{\sigma^2}{4} d(V), \quad (57)$$

an exact differential up to an infinitesimal rotation. Next we consider two real-valued stochastic processes defined on terms of the solution curves  $x(t) \in CP(n)$  of eq. (56), the Hamiltonian process defined by  $(H)(x(t))$  and the variance process  $V(x(t))$ . Then, from applying the Ito formula and formulae of Kahlerian

geometry, we find that  $(H)(x(t))$  satisfies a s.d.e. with zero drift, more specifically, it is a square-integrable martingale on  $R$ , while the variance process is a supermartingale, the latter describing the reduction of the wave function to a particular eigenstate; see [15,16]. In the present geometro-stochastic setting, we have associated to the reduction of the wave function in terms of the open Schroedinger equation, a geometry which is not riemannian, it has torsion given by the difference between the infinitesimal rotation of the differential of  $(H)$  and the differential of  $\frac{\sigma^2}{4}V$ ; the metric is not the original FS, and as a covariant tensor it has a singularity whenever  $(H)$  is constant, i.e. on a fixed eigenstate, for which the flow of eq.(56), becomes constantly equal to it if chosen for initial value.

## 10 RCW GEOMETRIES, BROWNIAN MOTIONS AND THE SCHROEDINGER EQUATION

We have seen that one can represent the space and time quantum geometries for the relativistic diffusion associated with the invariant distribution, so that  $Q = \frac{1}{2}d\ln\rho$ , and  $H_0(g, Q)$  has a self-adjoint extension for which we can construct the quantum geometry on state-space and still the stochastic extension of the Schroedinger equation defined by this operator on taking the analytical continuation on the time variable for the evolution parameter. In this section which follows the solution of the Schroedinger problem of interpolation by Nagasawa [38] interpreted in terms of the RCW geometries and the Hodge decomposition of the trace-torsion, we shall present the equivalence between RCW geometries, their Brownian motions and the Schroedinger equation. The fact that nonrelativistic quantum mechanics can be linked to torsion fields, has remained unseen till today, and we have proved this already for the stochastic Schroedinger equation. Thus, we shall now present the construction of non-relativistic quantum mechanics for the case that includes the full Hodge decomposition of the trace-torsion, so that  $Q = Q(t, x) = d\ln f_t(x) + A(t, x)$  where  $f(t, x) = f_t(x)$  is a function defined on the configuration manifold given by  $[a, b] \times M$  (where  $M$  is provided with a metric,  $g$ ), to be determined below, and  $A(t, x)$  is the sum of the harmonic and co-closed terms of the Hodge decomposition of  $Q$ , which we shall write as  $A(t, x) = A_t(x)$  as a time-dependent form on  $M$ . The scheme to determine  $f$  will be to manifest the time-reversal invariance of the Schroedinger representation in terms of a forward in time diffusion process and its time-reversed representation for the original equations for creation and destruction diffusion processes produced by the electromagnetic potential term of the trace-torsion of a RCW connection whose explicit form we shall determine in the sequel. From now onwards, the exterior differential, and the divergence operator will act on the  $M$  manifold variables only, for which we shall write then as  $df_t(x)$  to signal that the exterior differential acts only on the

$x$  variables of  $M$ . We should remark that in this context, the time-variable  $t$  of non-relativistic theory and the evolution parameter  $\tau$ , are identical [50]. This section stems from article [80]. Let

$$L = \frac{\partial}{\partial t} + \frac{1}{2}A(t, x) \cdot \nabla = \frac{\partial}{\partial t} + H(g, A_t) \quad (58)$$

(here, for unburdening the notation we omit the subscript 0 on  $H$  that recalls that operates on scalar fields) with

$$\delta \hat{A}_t = -\text{div}_g A_t = 0. \quad (59)$$

In this setting, we start with a background trace-torsion restricted to an electromagnetic potential. We think of this electromagnetic potential and the associated Brownian motion having its metric conjugate as its drift, as the background geometry of the vacuum, which we shall subsequently relate to a creation and destruction of particles and the equation of creation and annihilation is given by the following equation.

Let  $p(s, x; t, y)$  be the weak fundamental solution of

$$L\phi + c\phi = 0. \quad (60)$$

The interpretation of this equation as one of creation (whenever  $c > 0$ ) and annihilation (whenever  $c < 0$ ) of particles is warranted by the Feynman-Kac representation for the solution of this equation. Then  $\phi = \phi(t, x)$  satisfies the equation

$$\phi(s, x) = \int_M p(s, x; t, y) \phi(t, y) dy, \quad (61)$$

where for the sake of simplicity, we shall write in the sequel  $dy = \text{vol}_g(y) = \sqrt{\det(g)} dy^1 \wedge \dots \wedge dy^3$ . Note that we can start for data with a given function  $\phi(a, x)$ , and with the knowledge of  $p(s, x; a, y)$  we define  $\phi(t, x) = \int_M p(t, x; a, y) dy$ . Next we define

$$q(s, x; t, y) = \frac{1}{\phi(s, x)} p(s, x; t, y) \phi(t, y), \quad (62)$$

which is a transition probability density, i.e.

$$\int_M q(s, x; t, y) dy = 1, \quad (63)$$

while

$$\int_M p(s, x; t, y) dy \neq 1. \quad (64)$$

Having chosen the function  $\phi(t, x)$  in terms of which we have defined the probability density  $q(s, x; t, y)$  we shall further assume that we can choose a second bounded non-negative measurable function  $\hat{\phi}(a, x)$  on  $M$  such that

$$\int_M \phi(a, x) \hat{\phi}(a, x) dx = 1, \quad (65)$$

We further extend it to  $[a, b] \times M$  by defining

$$\hat{\phi}(t, y) = \int \hat{\phi}(a, x) p(a, x; t, y) dx, \forall (t, y) \in [a, b] \times M, \quad (66)$$

where  $p(s, x; t, y)$  is the fundamental solution of eq. (60).

Let  $\{X_t \in M, \mathcal{Q}\}$  be the time-inhomogeneous diffusion process in  $M$  with the transition probability density  $q(s, x; t, y)$  and a prescribed initial distribution density

$$\mu(a, x) = \hat{\phi}(t = a, x) \phi(t = a, x) \equiv \hat{\phi}_a(x) \phi_a(x). \quad (67)$$

The finite-dimensional distribution of the process  $\{X_t \in M, t \in [a, b]\}$  with probability measure on the space of paths which we denote as  $\mathcal{Q}$ ; for  $a = t_0 < t_1 < \dots < t_n = b$ , it is given by

$$\begin{aligned} E_{\mathcal{Q}}[f(X_a, X_{t_1}, \dots, X_{t_{n-1}}, X_b)] &= \int_M dx_0 \mu(a, x_0) q(a, x_0; t_1, x_1) dx_1 q(t_1, x_1; t_2, x_2) dx_2 \dots \\ &\dots q(t_{n-1}, x_{n-1}; b, x_n) dx_n f(x_0, x_1, \dots, x_{n-1}, x_n) \\ &:= [\mu_a q \gg] \end{aligned} \quad (68)$$

which is the Kolmogorov forward in time (and thus time-irreversible) representation for the diffusion process with initial distribution  $\mu_a(x_0) = \mu(a, x_0)$ , which using eq. (62) can still be rewritten as

$$\begin{aligned} \int_M dx_0 \mu_a(x_0) \frac{1}{\phi_a(x_0)} p(a, x_0; t_1, x_1) \phi_{t_1}(x_1) dx_1 \frac{1}{\phi_{t_1}(x_1)} dx_1 p(t_1, x_1; t_2, x_2) \phi_{t_2}(x_2) dx_2 \dots \\ \dots \frac{1}{\phi(t_{n-1}, x_{n-1})} p(t_{n-1}, x_{n-1}; b, x_n) \phi_b(x_n) dx_n f(x_0, \dots, x_n) \end{aligned} \quad (69)$$

which in account of  $\mu_a(x_0) = \hat{\phi}_a(x_0) \phi_a(x_0)$  and eq.(62) can be written in the time-reversible form

$$\int_M \phi_a(x_0) dx_0 p(a, x_0; t_1, x_1) dx_1 p(t_1, x_1; t_2, x_2) dx_2 \dots p(t_{n-1}, x_{n-1}; b, x_n) \phi_b(x_n) dx_n f(x_0, \dots, x_n) \quad (70)$$

which we write as

$$= [\hat{\phi}_a p \gg \ll p \phi_b]. \quad (71)$$

This is the *formally* time-symmetric Schroedinger representation with the transition (but not probability) density  $p$ . Here, the formal time symmetry is seen

in the fact that this equation can be read in any direction, preserving the physical sense of transition. This representation, in distinction with the Kolmogorov representation, does *not* have the Markov property.

We define the adjoint transition probability density  $\hat{q}(s, x; t, y)$  with the  $\hat{\phi}$ -transformation

$$\hat{q}(s, x; t, y) = \hat{\phi}(s, x)p(s, x; t, y)\frac{1}{\hat{\phi}(t, y)} \quad (72)$$

which satisfies the Chapman-Kolmogorov equation and the time-reversed normalization

$$\int_M dx \hat{q}(s, x; t, y) = 1. \quad (73)$$

We get

$$E_{\hat{Q}}[f(X_a, X_{t_1}, \dots, X_b)] = \int_M f(x_0, \dots, x_n) \hat{q}(a, x_0; t_1, x_1) dx_1 \hat{q}(t_1, x_1; t_2, x_2) dx_2 \dots \dots \hat{q}(t_{n-1}, x_{n-1}; b, x_n) \hat{\phi}(b, x_n) \phi(b, x_n) dx_n, \quad (74)$$

which has a form non-invariant in time, i.e. illegible from right to left, as

$$\lll \hat{q} \hat{\phi}_b \phi_b \rrr = \lll \hat{q} \hat{\mu}_b \rrr, \quad (75)$$

which is the time-reversed representation for the final distribution  $\mu_b(x) = \hat{\phi}_b(x)\phi_b(x)$ . Now, starting from this last expression and rewriting in a similar form that in the forward process but now with  $\hat{\phi}$  instead of  $\phi$ , we get

$$\int_M dx_0 \hat{\phi}_a(x_0) p(a, x_0; t_1, x_1) \frac{1}{\hat{\phi}_{t_1}(x_1)} dx_1 \hat{\phi}(t_1, x_1) p(t_1, x_1; t_2, x_2) \frac{1}{\hat{\phi}_{t_2}(x_2)} dx_2 \dots dx_{n-1} \hat{\phi}(t_{n-1}, x_{n-1}) p(t_{n-1}, x_{n-1}; b, x_n) \frac{1}{\hat{\phi}(b, x_n)} \hat{\phi}_b(x_n) \phi(b, x_n) dx_n f(x_0, \dots, x_n) \quad (76)$$

which coincides with the time-reversible Schroedinger representation  $[\hat{\phi}_a p \gg \lll p \phi_b]$ .

We therefore have three equivalent representations for the diffusion process, one the forward in time Kolmogorov representation, the backward Kolmogorov representation, both of them are naturally irreversible in time, and the time-reversible Schroedinger representation, so that we can write succinctly,

$$[\mu_a q \gg] = [\hat{\phi}_a p \gg \lll p \phi_b] = \lll \hat{q} \mu_b \rrr, \text{ with } \mu_a = \phi_a \hat{\phi}_a, \mu_b = \phi_b \hat{\phi}_b. \quad (77)$$

In addition of this formal identity, we have to establish the relations between the equations that have lead to them. We first note, that in the Schroedinger representation, which is formally time-reversible, we have an interpolation of

states between the initial data  $\hat{\phi}_a(x)$  and the final data,  $\phi_b(x)$ . The information for this interpolation is given by a filtration of interpolation  $\mathcal{F}_a^r \cup \mathcal{F}_b^s$ , which is given in terms of the filtration for the forward Kolmogorov representation  $\mathcal{F} = \mathcal{F}_a^t, t \in [a, b]$  which is used for prediction starting with the initial density  $\phi_a \hat{\phi}_a = \mu_a$  and the filtration  $\mathcal{F}_t^b$  for retrodiction for the time-reversed process with initial distribution  $\mu_b$ .

We observe that  $q$  and  $\hat{q}$  are in time-dependent duality with respect to the measure

$$\mu_t(x)dx = \hat{\phi}_t(x)\phi_t(x)dx, \quad (78)$$

since if we define the time-homogeneous semigroups

$$Q_{t-s}f(s, x) = \int q(s, x; t, y)f(t, y)dy, s < t \quad (79)$$

$$g\hat{Q}_{t-s}(t, y) = \int dxg(s, x)\hat{q}(s, x; t, y), s < t, \quad (80)$$

then

$$\begin{aligned} \int dx\mu_s(x)g(s, x)Q_{t-s}f(s, x) &= \int dxg(s, x)\phi_s(x)\hat{\phi}_s(x)\frac{1}{\phi_s(x)}p(s, x; t, y)\phi_t(y)f(t, y)dy \\ &= \int dxg(s, x)\hat{\phi}_s(x)p(s, x; t, y)\frac{1}{\hat{\phi}_t(y)}f(t, x)\hat{\phi}_t(y)\phi_t(y)dy \\ &= \int dxg(s, x)\hat{q}(s, x; t, y)f(t, y)\hat{\phi}_t(y)\phi_t(y)dy \\ &= \int dxg(s, x)\hat{Q}_{t-s}(t, y)f(t, y)\mu_t(y)dy \end{aligned} \quad (81)$$

i.e.

$$\langle g, Q_{t-s}f \rangle_{\mu_s} = \langle g\hat{Q}_{t-s}, f \rangle_{\mu_t}, s < t. \quad (82)$$

We shall now extend the state-space of the diffusion process to  $[a, b] \times M$ , to be able to transform the time-inhomogeneous processes into time-homogeneous, while the stochastic dynamics is still taken place exclusively in  $M$ . This will allow us to define the duality of the processes to be with respect to  $\mu_t(x)dtdx$  and to determine the form of the exact term of the trace-torsion, and ultimately, to establish the relation between the diffusion processes and Schroedinger equations, both for potential linear and non-linear in the wave-functions. If we define time-homogeneous semigroups of the processes on  $\{(t, X_t) \in [a, b] \times M\}$  by

$$P_r f(s, x) = \begin{cases} Q_{s, s+r}f(s, x) & , s \geq 0 \\ 0 & , \text{otherwise} \end{cases} \quad (83)$$

and

$$\hat{P}_r g(t, y) = \begin{cases} gQ_{t-r, t}(t, y) & , r \geq 0 \\ 0 & , \text{otherwise} \end{cases} \quad (84)$$

then

$$\begin{aligned} \langle g, P_r f \rangle_{\mu_t dt dx} &= \int_r^{b-r} ds \langle g, Q_{s, s+r} f \rangle_{\mu_s} = \int_b^{a+r} \langle g, Q_{t-r, t} f \rangle_{\mu_{t-r}(x)} dx \\ &= \int_{a+r}^b dt \langle g \hat{P}_{t-r}, f \rangle_{\mu_t dx} = \langle \hat{P}_r g, f \rangle_{\mu_t dt dx}, \end{aligned} \quad (85)$$

which is the duality of  $\{(t, X_t)\}$  with respect to the  $\mu_t dt dx$  density. Consequently, if in our space-time case we define for  $a_t(x), \hat{a}_t(x)$  time-dependent one-forms on  $M$  (to be determined later)

$$B\alpha : = \frac{\partial \alpha}{\partial t} + H(g, A_t + a_t)\alpha_t \quad (86)$$

$$B^0 \mu : = -\frac{\partial \mu}{\partial t} + H(g, A_t + a_t)^\dagger \mu_t, \quad (87)$$

and its adjoint operators

$$\hat{B}\beta = -\frac{\partial \beta}{\partial t} - H(g, -A_t + \hat{a}_t)^\dagger \beta_t, \quad (88)$$

$$(\hat{B})^0 \mu_t = \frac{\partial \mu_t}{\partial t} - H(g, -A_t + \hat{a}_t)^\dagger \mu_t, \quad (89)$$

where by  $H^\dagger$  we mean the  $\text{vol}_g$ -adjoint of the operator  $H$  defined as in eq.(22). Now

$$\begin{aligned} \int_a^b dt \int 1_{D_t} [(B\alpha_t)\beta_t] - \alpha_t (\hat{B}\beta_t) \mu_t(x) dx &= \int_a^b dt \int 1_{D_t} \alpha_t \beta_t (B^0 \mu_t) dx \\ &- \int_a^b \int 1_{D_t} \alpha_t g([a_t + \hat{a}_t] - d \ln \mu_t, d\beta_t) \mu_t dx \end{aligned} \quad (90)$$

for arbitrary  $\alpha, \beta$  smooth compact supported functions defined on  $[a, b] \times M$  which we have denoted as time-dependent functions  $\alpha_t, \beta_t$ , where  $1_{D_t}$  denotes the characteristic function of the set  $D_t(x) := \{(t, x) : \mu_t(x) = \phi_t(x)\hat{\phi}_t(x) > 0\}$ . Therefore, the duality of space-time processes

$$\langle B\alpha, \beta \rangle_{\mu_t(x) dt dx} = \langle \alpha, \hat{B}\beta \rangle_{\mu_t(x) dt dx}, \quad (91)$$

is equivalent to

$$a_t(x) + \hat{a}_t(x) = d \ln \mu_t(x) \equiv d \ln \phi_t(x)\hat{\phi}_t(x), \quad (92)$$

$$B^0 \mu_t(x) = 0, \quad (93)$$

and the latter equation being the Fokker-Planck equation for the diffusion with trace-torsion given by  $a + A$ , then the Fokker-Planck equation for the adjoint (time-reversed) process is valid, i.e.

$$(\hat{B})^0 \mu_t(x) = 0. \quad (94)$$

Substracting eqts. (93, 94) we get the final form of the duality condition

$$\frac{\partial \mu}{\partial t} + \text{div}_g[(A_t + \frac{a_t - \hat{a}_t}{2})\mu_t] = 0, \text{ for } \mu_t(x) = \hat{\phi}_t(x)\phi_t(x) \quad (95)$$

Therefore, we can establish that the duality conditions of the diffusion equation in the Kolmogorov representation and its time reversed diffusion lead to the following conditions on the additional elements of the drift vectorfields:

$$a_t(x) + \hat{a}_t(x) = d\ln\mu_t(x) \equiv d\ln\phi_t(x)\hat{\phi}_t(x), \quad (96)$$

$$\frac{\partial \mu}{\partial t} + \text{div}_g[(A_t + \frac{a_t - \hat{a}_t}{2})\mu_t] = 0. \quad (97)$$

If we assume that  $a_t - \hat{a}_t$  is an exact one-form, i.e., there exists a time-dependent differentiable function  $S(t, x) = S_t(x)$  defined on  $[a, b] \times M$  such that for  $t \in [a, b]$ ,

$$a_t - \hat{a}_t = d\ln \frac{\phi_t(x)}{\hat{\phi}_t(x)} = 2dS_t \quad (98)$$

which together with

$$a_t + \hat{a}_t = d\ln\mu_t, \quad (99)$$

implies that on  $D(t, x)$  we have

$$a_t = d\ln\phi_t, \quad (100)$$

$$\hat{a}_t = d\ln\hat{\phi}_t. \quad (101)$$

**Remark.** Note that the time-dependent function  $S$  on the 3-space manifold, is defined by eq. (98) up to addition of an arbitrary function of  $t$ , and when further below we shall take this function as defining the complex phase of the quantum Schroedinger wave, this will introduce the quantum-phase indetermination of the quantum evolution, just as we discussed already in the setting of geometry of the quantum state-space. In the other hand, this introduces as well the subject of the multivaluedness of the wave function, which by the way, leads to the Bohr-Sommerfeld quantization rules of quantum mechanics established well before it was developed as an operator theory. It is noteworthy to remark that these quantization rules, later encountered in superfluidity and superconductivity, or still in the physics of defects of condensed matter physics, are of topological character. Later we shall see that the Schroedinger wave equation contains the Navier-Stokes equations for a viscous fluid in 2D, and the probability density of the Brownian motions or still of the quantum system, will be transformed into the enstrophy of the viscous fluid obeying the Navier-Stokes equations. Thus, one might expect that Navier-Stokes equations could also have multivalued solutions, namely in the 2D case of the already established relation, the vorticity reduces to a time-dependent function.<sup>16</sup> Multivaluedness of the

<sup>16</sup>This comment follows Vic Christiano's kind insistence in the need of exploring the possible existence of multivalued solutions to the Navier-Stokes equations.



solutions of the Schroedinger equation has been proposed [52] as evidence that the multivalued logics due to Post have to be incorporated in physics, and cognition in general (which surely is the case in our uses of languages in daily life), which would replace the probabilistic features of quantum mechanics.<sup>17</sup>

Introduce now  $R_t(x) = R(t, x) = \frac{1}{2} \ln \phi_t \hat{\phi}_t$  and  $S_t(x) = S(t, x) = \frac{1}{2} \ln \frac{\phi_t}{\hat{\phi}_t}$ , so that

$$a_t(x) = d(R_t + S_t), \quad (102)$$

$$\hat{a}_t(x) = d(R_t - S_t), \quad (103)$$

and the eq. (97) takes the form

$$\frac{\partial R}{\partial t} + \frac{1}{2} \Delta_g S_t + g(dS_t, dR_t) + g(A_t, dR_t) = 0, \quad (104)$$

where we have taken in account that  $\text{div}_g A_t = 0$ .

Therefore, together with the three different time-homogeneous representations  $\{(t, X_t), t \in [a, b], X_t \in M\}$  of a time-inhomogeneous diffusion process  $\{X_t, Q\}$  on  $M$  we have three equivalent dynamical descriptions. One description, with creation and killing described by the scalar field  $c(t, x)$  and the diffusion equation describing it is given by a creation-destruction potential in the trace-torsion background given by an electromagnetic potential

$$\frac{\partial p}{\partial t} + H(g, A_t)(x)p + c(t, x)p = 0; \quad (105)$$

the second description has an additional trace-torsion  $a(t, x)$ , a 1-form on  $R \times M$

$$\frac{\partial q}{\partial t} + H(g, A + a_t)q = 0. \quad (106)$$

while the third description is the adjoint time-reversed of the first representation given by  $\hat{\phi}$  satisfying the diffusion equation on the background of the reversed electromagnetic potential  $-A$  in the vacuum, i.e.

$$-\frac{\partial \hat{\phi}}{\partial t} + H(g, -A_t)\hat{\phi} + c\hat{\phi} = 0. \quad (107)$$

---

<sup>17</sup>Pensinger and Paine, preceded Prigogine [74] -who stressed the formative role of time in all systems and an approach through resonances in dynamical systems- in claiming an approach to collective phenomenae in the social sciences based in quantum mechanics and the formative role of time (the latter being absent in historiography, but certainly present in Nature, as we have discussed above.). Furthermore, these authors claim that the probabilistic approach attempted to replace the Aristoteles-Boole logic for its failure to account for the localization problem, and that the probabilistic approach was conceived as a rejection of a multiple identity conception. As we have seen in this article, the probabilistic approach to quantum mechanics is equivalent to geometrical structures, and thus the multivalued logics would thus be linked to RCW geometries through the multivaluedness of the logarithmic potential of the trace-torsion, when we extend the wave function to the complex domain, or still more generally, to the quaternionic and octonionic spaces. In fact, the so called Smarandache geometries might be related to this view of spacetime geometries as associated to multivalued logics and to the coexistence of multiple structures [76].

The second representation for the full trace-torsion diffusion forward in time Kolmogorov representation, we need to adopt the description in terms of the fundamental solution  $q$  of

$$\frac{\partial q}{\partial t} + H(g, A_t + a_t)q = 0, \quad (108)$$

for which one must start with the initial distribution  $\mu_a(x) = \hat{\phi}_a(x)\phi_a(x)$ . This is a time  $t$ -irreversible representation in the real world, where  $q$  describes the real transition and  $\mu_a$  gives the initial distribution. If in addition one traces the diffusion backwards with reversed time  $t$ , with  $t \in [a, b]$  running backwards, one needs for this the final distribution  $\mu_b(x) = \hat{\phi}_b(x)\phi_b(x)$  and the time  $t$  reversed probability density  $\hat{q}(s, x; t, y)$  which is the fundamental solution of the equation

$$-\frac{\partial \hat{q}}{\partial t} + H(g, -A_t + \hat{a}_t)\hat{q} = 0, \quad (109)$$

with additional trace-torsion one-form on  $R \times M$  given by  $\hat{a}$ , where

$$\hat{a}_t + a_t = d\ln\mu_t(x). \quad (110)$$

where the diffusion process in the time-irreversible forward Kolmogorov representation is given by the Ito s.d.e

$$dX_t^i = \sigma_j^i(X_t)dW_t^j + (A + a)^i(t, X_t)dt, \quad (111)$$

and the backward representation for the diffusion process is given by

$$dX_t^i = \sigma_j^i(X_t)dW_t^j + (-A + \hat{a})^i(t, X_t)dt, \quad (112)$$

where  $a, \hat{a}$  are given by the eqs. (102) and (103), and  $(\sigma\sigma^\dagger)^{\alpha\beta} = g^{\alpha\beta}$

We follow Schroedinger in pointing that  $\phi$  and  $\hat{\phi}$  separately satisfy the creation and killing equations, while in quantum mechanics  $\psi$  and  $\bar{\psi}$  are the complex-valued counterparts of  $\phi$  and  $\hat{\phi}$ , respectively, they are not arbitrary but

$$\phi\hat{\phi} = \psi\bar{\psi}. \quad (113)$$

Thus, in the following, this Born formula, once the equations for  $\psi$  are determined, will be a consequence of the constructions, and not an hypothesis on the random basis of non-relativistic mechanics.

Therefore, the equations of motion given by the Ito s.d.e.

$$dX_t^i = (\hat{A} + \text{grad}\phi)^i(t, X_t)dt + \sigma_j^i(X_t)dW_t^j, \quad (114)$$

which are equivalent to

$$\frac{\partial u}{\partial t} + H(g, A_t + a_t)u = 0 \quad (115)$$

with  $a = d\ln\phi = d(R + S)$ , determines the motion of the ensemble of non-relativistic particles. Note that this equivalence requires only the Laplacian for the RCW connection with the forward trace-torsion full one-form  $Q = A + d\ln\phi = A + d(R + S)$ . In distinction with Stochastic Mechanics due to Nelson, and contemporary elaborations of this applied to astrophysics as the theory of Scale Relativity due to Nottale [31][34], we only need the form of the trace-torsion for the forward Kolmogorov representation, and this turns to be equivalent to the Schroedinger representation which interpolates in time-symmetric form between this forward process and its time dual with trace-torsion one-form given by  $-A + \hat{a} = -A + d\ln\hat{\phi} = -A + d(R - S)$ .

Finally, let us how this is related to the Schroedinger equation. Consider now the Schroedinger equations for the complex-valued wave function  $\psi$  and its complex conjugate  $\bar{\psi}$ , i.e. introducing  $i = \sqrt{-1}$ , we write them in the form

$$i \frac{\partial \psi}{\partial t} + H(g, iA_t)\psi - V\psi = 0 \quad (116)$$

$$-i \frac{\partial \bar{\psi}}{\partial t} + H(g, -iA_t)\bar{\psi} - V\bar{\psi} = 0, \quad (117)$$

which are identical to the usual forms. So, we have the imaginary factor appearing in the time  $t$  but also in the electromagnetic term of the RCW connection with trace-torsion given now by  $iA$ , which we confront with the diffusion equations generated by the RCW connection with trace-torsion  $A$ , i.e. the system

$$\frac{\partial \phi}{\partial t} + H(g, A_t)\phi + c\phi = 0, \quad (118)$$

$$\frac{-\partial \hat{\phi}}{\partial t} + H(g, -A_t)\hat{\phi} + c\hat{\phi} = 0, \quad (119)$$

and the diffusion equations determined by both the RCW connections with trace-torsion  $A + a$  and  $-A + \hat{a}$ , i.e.

$$\frac{\partial q}{\partial t} + H(g, A_t + a_t)q = 0, \quad (120)$$

$$\frac{-\partial \hat{q}}{\partial t} + H(g, -A_t + \hat{a}_t)\hat{q} = 0, \quad (121)$$

which are equivalent to the single equation

$$\frac{\partial q}{\partial t} + H(g, A_t + d\ln\phi_t)q = 0. \quad (122)$$

If we introduce a complex structure on the two-dimensional real-space with coordinates  $(R, S)$ , i.e. we consider

$$\psi = e^{R+iS}, \bar{\psi} = e^{R-iS}, \quad (123)$$

viz a viz  $\phi = e^{R+s}$ ,  $\hat{\phi} = e^{R-S}$ , with  $\psi\bar{\psi} = \phi\hat{\phi}$ , then for a wave-function differentiable in  $t$  and twice-differentiable in the space variables, then,  $\psi$  satisfies the Schroedinger equation if and only if  $(R, S)$  satisfy the difference between the Fokker-Planck equations, i.e.

$$\frac{\partial R}{\partial t} + g(dS_t + A_t, dR_t) + \frac{1}{2}\Delta_g S_t = 0, \quad (124)$$

and

$$V = -\frac{\partial S}{\partial t} + H(g, dR_t)R_t - \frac{1}{2}g(dS_t - A_t, dS_t). \quad (125)$$

which follows from substituting  $\psi$  in the Schroedinger equation and further dividing by  $\psi$  and taking the real part and imaginary parts, to obtain the former and latter equations, respectively.

Conversely, if we take the coordinate space given by  $(\phi, \hat{\phi})$ , both non-negative functions, and consider the domain  $D = D(s, x) = \{(s, x) : 0 < \hat{\phi}(s, x)\phi(s, x)\} \subset [a, b] \times M$  and define  $R = \frac{1}{2}\ln\phi\hat{\phi}$ ,  $S = \frac{1}{2}\ln\frac{\phi}{\hat{\phi}}$ , with  $R, S$  having the same differentiability properties that previously  $\psi$ , then  $\phi = e^{R+S}$  satisfies in  $D$  the equation

$$\frac{\partial \phi}{\partial t} + H(g, A_t)\phi + c\phi = 0, \quad (126)$$

if and only if

$$\begin{aligned} -c &= \left[-\frac{\partial S}{\partial t} + H(g, dR_t)R_t - \frac{1}{2}g(dS_t, dS_t) - g(A_t, dS_t)\right] \\ &+ \left[\frac{\partial R}{\partial t} + H(g, dR_t)S_t + g(A_t, dR_t)\right] + \left[2\frac{\partial S}{\partial t} + g(dS_t + 2A_t, dS_t)\right] \end{aligned} \quad (127)$$

while  $\hat{\phi} = e^{R-S}$  satisfies in  $D$  the equation

$$-\frac{\partial \hat{\phi}}{\partial t} + H(g, -A_t)\hat{\phi} + c\hat{\phi} = 0, \quad (128)$$

if and only if

$$\begin{aligned} -c &= \left[-\frac{\partial S}{\partial t} + H(g, dR_t)R_t - \frac{1}{2}g(dS_t, dS_t) - g(A_t, dS_t)\right] \\ &- \left[\frac{\partial R}{\partial t} + H(g, dR_t)S_t + g(A_t, dR_t)\right] + \left[2\frac{\partial S}{\partial t} + g(dS_t + 2A_t, dS_t)\right] \end{aligned} \quad (129)$$

Notice that  $\phi, \hat{\phi}$  can be both negative or positive. So if we define  $\psi = e^{R+iS}$ , it then defines in weak form the Schroedinger equation in  $D$  with

$$V = -c - 2\frac{\partial S}{\partial t} - g(dS_t, dS_t) - 2g(A_t, dS_t). \quad (130)$$

We note that from eq. (130) follows that we can choose  $S$  in a way such that either  $c$  is independent of  $S$  and thus  $V$  is a potential which is non-linear in the sense that it depends on the phase of the wave function  $\psi$  and thus the Schroedinger equation with this choice becomes non-linear dependent of  $\psi$ , or conversely, we can make the alternative choice of  $c$  depending non-linearly on  $S$ , and thus the creation-annihilation of particles in the diffusion equation is non-linear, and consequently the Schroedinger equation has a potential  $V$  which does not depend on  $\psi$ .

With respect to the issue of nonlinearity of the Schroedinger equation, one could argue that the former case means that the superposition principle of quantum mechanics is broken, but then one observes that precisely due to the fact that the wave function depends on the phase, the superposition principle is invalid from the fact that we are dealing with complex-valued wave functions, and what matters, is the evolution in state-space where the complex factor has been quotiented. In the former case of a non-linear Schroedinger equation, we note that the symplectic state-space formulation is still valid [18] and the quantum geometry description incorporates non-linear quantum mechanics as is the case of the Lie-isotopic theory of Santilli, when we place in evidence in the equation, the isotopic unit of the Lie-isotopic Schroedinger-Santilli equation; see Santilli [40]. In the case that  $V$  is such that the spectrum of  $H(g, A + a)$  is discrete, we know already we can represent the Schroedinger equation in state-space and further study the related stochastic Schroedinger equation as described above. Finally, we have presented a construction in which by using two scalar diffusing processes  $\phi, \hat{\phi}$  we have been able to subsume them into a single forward in time process with additional trace-torsion given by  $a_t = d\ln\phi_t\hat{\phi}_t$ , where  $\mu_t = \phi_t\hat{\phi}_t$  is the distribution of the diffusion process, and obtain under eqts. (118) the Schroedinger equation (110). Alternatively, it is known that we can start with  $2D$  space and the Schroedinger equation, we obtain a pair of equations, one of them being the Navier-Stokes equations for a compressible fluid where now  $\phi_t\hat{\phi}_t = \psi_t\bar{\psi}_t$  equals the enstrophy of the fluid. Thus, the formal-time reversible representation can indeed be linked with the irreversible dynamics of a viscous fluid, but now the density is given by the square of the vorticity, that in this case can be associated with a function [33]; the case for this correspondance for spatial  $3D$  requires to be proved. This represents a mapping between two RCW structures (inasmuch the correspondance between the sourceless Maxwell and Dirac-Hestenes equations is another example [2], [49]), since as we have seen in [1] and [32], the Navier-Stokes equations as well as the equations of passive transport of a magnetic field on a fluid, are basic examples of RCW geometries whose dynamics can be represented in terms of Brownian motions, both for boundaryless manifolds and the case of smooth boundary manifolds as well. Finally, we would like to stress that from those Brownian motions, and in particular for the cases of the Schroedinger equation and its stochastic extension in state-space, we can build Poincaré-Cartan random integral invariants [1]; this will be presented in detail elsewhere.

Nonlinear Schroedinger equations have an important role in theoretical physics, as well as the Lie-isotopic extensions of the linear Schroedinger equation and of Quantum Mechanics, due to Santilli [40]. In the most interesting theory due to Santilli developed along forty years of work, it is assumed that at very short distances the quantum forces are no longer due to contact interaction representable by the quantum semigroup rules that extend the symplectic approach to nondissipative classical mechanics. These interactions arise from the overlap of the wavefunctions, and thus cannot be formally represented as in the usual approach. Thus, Santilli sets an epistemologic frontier in what is known as the interior problem of hyperdense matter and noncontact interactions, and the exterior problem which is the usually treated by the theoretical physics to nondissipative systems. To obtain a consistent theory, a modification of the theory of numbers (known as isoarithmetic and isoalgebra) is produced incorporating an arbitrary unit (which will carry the information on the overlap of the wavefunctions of the constitutive elements of the quantum system under noncontact interaction, as well as information as the nonconstant viscosity or diffraction index, temperature, high compression), which is further carried to produce a modification of differential calculus in term of an isotopic differential, and thus a modification of the Schroedinger equation follows. In terms of an extension of the theory of general relativity, the corresponding modification is thought in terms again of the so-called interior problem corresponding to ultradense matter or spin. In the large scale exterior problem, Lie-isotopic theory recovers all the usual theories of quantum mechanics and relativity. The point of view due to Santilli is different than the one presented here, in which we present a basis for phenomenae in a form that although can be introduced in terms of scale fields, the theory is essentially topological inasmuch the torsion field is of topological origin: the nonclosure of infinitesimal parallelograms. Thus, the Schroedinger equation as presented here as well as the Brownian motions associated to RCW geometries, does not appear as linked to a particular scale, they are universal structures. Furthermore, from our analysis above, the fact that the Schroedinger equation be linear or nonlinear is not the main issue, we can always choose where to set the nonlinearity, either in the creation or annihilation potential, or in the potential function  $V$  that has been historically attached to quantum physics. It is remarkable that Santilli's theory can be mapped into the present at least for certain types of units which as generators of the trace-torsion [55]. From Santilli's theory, a new formulation of chemical bonds is produced [64].

Yet, if we remain in the context of the exterior problem for quantum systems as described by quantum mechanics, in Santilli's work there is no analysis of the deeper structures and phenomenae that may arise in the exterior problem at large, nor at the relation between the aether and the exterior problem at large, as conceived in the present work, while at the level of the interior level, the existence of an elementary particle is hypothesized, the so-called aetherino. While in the so-called interior problem, the torsion produced by the isotopic

unit which is the cornerstone of the Santilli- Lie-isotopic theory can depend on additional parameters that represent the modifications due to the overlap of the wavepackets of the quantum system and as well as due to the thermodynamics irreversible processes taking part within the boundaries set for the system to distinguish it from the canonical formalism for classical and quantum systems, the present theory presents a view of phenomenae which is free of the establishment of boundaries (which can be somehow artificial or ad-hoc). In a theory of the aether in which the non-trivial topological forces represented by geometrical torsion are at the foundations, and the structures that arise from it are valid in all scales such as vortices, spinor fields, minimal surfaces, as we shall briefly present in the next section.

Returning to the issue of the nonlinearity of the potential function  $V$  in quantum mechanics, the usual form is the known logarithmic expression  $V = -b(\ln|\psi|^2)\psi$  introduced by Bialnicky-Birula and Mycielski [57]. Its importance in such diverse fields as quantum optics, superconductivity, atomic and molecular physics cannot be disregarded. Soliton solutions of nonlinear Schroedinger equations may have a role central to molecular biology, in which the DNA structure may be associated with a superconductive state. With regards as the relation between geometries, Brownian motions and the linear and Schroedinger equations, there is an alternative line of research which stems from two principles, one of them strongly related to the present one. The first is that all physical fields have to be construed in terms of scale fields starting from the fields appearing in the Einstein lambda transformations, of which, the Schroedinger wave function is an elementary example as shown here (see Rapoport [58]), and when further associated to the idea of a fractal spacetime, this has lead to Nottale's theory of Scale Relativity [31]. Nottale's theory starts from this fractal structure to construct a covariant derivative operator in terms of the forward and backward stochastic derivatives introduced by Nelson in his theory of stochastic mechanics [14]. In Nelson's conception, Brownian motions and quantum systems are aggregates to spacetime, they are not spacetime structures themselves; this is a completely different conception that the one elaborated in this article. Working with these stochastic derivatives, the basic operator of Nottale's theory, can be written in terms of our RCW laplacian operators of the form  $\frac{\partial}{\partial \tau} + H_0(i\mathcal{D}g, \mathcal{V})$  where  $\mathcal{D}$  is diffusion constant (equal to  $\frac{\hbar}{2m}$  in nonrelativistic quantum mechanics), and  $\mathcal{V}$  is a complex differentiable velocity field, our complex drift appearing after introducing the imaginary unit  $i = \sqrt{-1}$ ; see Nottale [61]. In the present conception, this fundamental operator in terms of which Nottale constructs his theory which has lead to numerous predictions of the positions of exoplanets confirmed by observations [34], does not require to assume that spacetime has a fractal structure a priori, from which stochastic derivatives backward and forward to express the time asymmetry construct the dynamics of fields. We rather assume that at a fundamental scale which is generally associated with the Planck scale, we can represent spacetime as a continuous in which what really matters are the defects in these continuous, and thus torsion

has such a fundamental role. The fractal structure of spacetime arises from the association between the RCW laplacian operators which as we said coincide with Nottale's covariant derivative operator, and the Brownian motions which alternatively, can be seen as constructing the spacetime geometry. So there is no place as to the discussion of what goes first, at least in the conception in the present work. The flow of these Brownian motions under general analytical conditions, define for every trial Wiener path, an active diffeomorphism of spacetime. But this primeval role of the Brownian motions and fractal structures, stems from our making the choice -arbitrary, inasmuch as the other choice is arbitrary- as the fundamental structure instead of choosing the assumption of having a RCW covariant derivative with a trace-torsion field defined on a continuous model of spacetime. In some sense the primeval character of Brownian motions as a starting point is very interesting in regards that they can be constructed as continuous limits of discrete jumps, as every basic book in probability presents [66], and thus instead of positing a continuous spacetime, we can think from the very beginning in a discrete spacetime, and construct a theory of physics in these terms as suggested in [63] <sup>18</sup> In this case, instead of working with the field of the real number or its complex or biquaternion extensions, one can take a p-adic field, such as the one defined by the Mersenne prime number  $2^{127} - 1$  which is approximately equal to the square of the ratio between the Planck mass and the proton mass [63]. This program and its relations with the fundamental constants of physics, was elaborated independently by a number of authors and an excellent presentation can be found in Castro [64] and references therein. In fact, a theory of physics in terms of discrete structures associated to the Mersenne prime numbers hierarchy, has been constructed in a program developed by P. Noyes, T. Bastin, P. Kilmister and others; see [67]. A remarkable unified theory of physics, genetics and consciousness in terms of p-adic field theory, has been elaborated by M. Pitkanen, which has been briefly presented in this volume [75].

Returning to our discussion of the work by Nottale, we would like to comment that Castro and Mahecha (see [59] and chapter of this book) and Castro, Mahecha and Rodriguez [60], following the Nottale constructions have derived the nonlinear Schroedinger equation and associated it to a Brownian motion with a complex diffusion constant. Furthermore, working with Weyl connections (which are to be distinguished from the present work's Riemann-Cartan-Weyl connections) in that they are not integrable and they have zero torsion (they can be introduced in terms of the reduced set of Einstein lambda transformations when one does not posit the tetrad or cotetrad fields as fundamental and the invariance of the Riemann-Cartan connection), they have derived the relativistic quantum potential in terms of the difference between the Weyl curvature of this connection and the Riemannian curvature, while in the present theory,

---

<sup>18</sup>Prof. Shan Gao, has initiated a program of construction of quantum mechanics as random discontinuous motions in discrete spacetime, in his recent work *Quantum Motion, Unveiling the Mysterious Quantum World*, Arima Publ., Suffolk (U.K.), 2006.



we have associated above the relativistic quantum potential with the Riemannian curvature, which is more closely related with the idea of Brownian motion in spacetime (without additional internal degrees of freedom as the Weyl connections introduce) as being the generator of gravitation and all fundamental fields.

## 11 THE NAVIER-STOKES EQUATIONS AND RIEMANN-CARTAN-WEYL DIFFUSIONS

We have seen that quantum mechanics is an example of spacetime structures of RCW. We have shortly discussed the fact that the Navier-Stokes equations for viscous fluids are another example of this. In this section we shall present the proofs of this statements.

In the sequel,  $M$  is a compact orientable ( *without boundary*)  $n$ -manifold with a Riemannian metric  $g$ . We provide  $M$  with a 1-form  $u(\tau, x) = u_\tau(x)$  satisfying the invariant Navier-Stokes equations (NS in the following) ,

$$\frac{\partial u}{\partial \tau} + P[\nabla_{\hat{u}_\tau}^g u_\tau] - \nu \Delta_1 u_\tau = 0, \quad (131)$$

where  $P$  is the projection operator to the co-closed term in the de Rham-Kodaira-Hodge decomposition of 1-forms. We have proved in [1,32], that we can rewrite NS in the form of a non-linear diffusion equation<sup>19</sup>

$$\frac{\partial u}{\partial \tau} = PH_1(2\nu g, \frac{-1}{2\nu} u_\tau) u_\tau, \quad (132)$$

which means that NS for the velocity of an incompressible fluid is a a non-linear diffusion process determined by a RCW connection. This connection has  $2\nu g$  for the metric, and the time-dependant trace-torsion of this connection is  $-u/2\nu$ . Then, the drift of this process does not depend explicitly on  $\nu$ , as it coincides with the vectorfield associated via  $g$  to  $-u_\tau$ , i.e.  $-\hat{u}_\tau$ . Let us introduce the vorticity two-form

$$\Omega_\tau = du_\tau, \tau \geq 0. \quad (133)$$

Now, apply  $d$  to eq. (132); since  $d\Delta_1 u_\tau = \Delta_2 du_\tau = \Delta_2 \Omega_\tau$  and  $dL_{\hat{u}_\tau} = L_{\hat{u}_\tau} du_\tau = L_{\hat{u}_\tau} \Omega_\tau$  we obtain the evolution equation for the vorticity (the so called Navier-Stokes equation for the vorticity):

$$\frac{\partial \Omega_\tau}{\partial \tau} = H_2(2\nu g, \frac{-1}{2\nu} u_\tau) \Omega_\tau. \quad (134)$$

---

<sup>19</sup>While in the boundaryless case  $P$  commutes with  $\Delta_1$ , in the case of  $M$  with smooth boundary this is no longer true so that we have to take  $P\Delta_1 u_\tau$  instead of the viscosity term in eq. (131) , and we are left with the non-linear diffusion equation (132) in any case.

Now, if we know  $\Omega_\tau$  for any  $\tau \geq 0$ , we can obtain  $u_\tau$  by inverting the definition (133). Namely, applying  $\delta$  to (133) we obtain the Poisson-de Rham equation

$$H_1(g, 0)u_\tau = -d\delta u_\tau - \delta\Omega_\tau, \tau \geq 0. \quad (135)$$

Thus, the vorticity  $\Omega_\tau$  is a source for the velocity one-form  $u_\tau$ , for all  $\tau$  together with the predetermined expression for  $\delta u_\tau$ ; in the case that  $M$  is a compact euclidean domain, eq. (135) is integrated to give the Biot-Savart law of Fluid Mechanics. If furthermore the fluid is incompressible, i.e.  $\delta u_\tau = 0$ , then we get the Poisson-de Rham equation for the velocity having the vorticity as a source,

$$H_1(g, 0)u_\tau = -\delta\Omega_\tau, \tau \geq 0. \quad (136)$$

In 3D this is none other than the Biot-Savart law but applied to fluid dynamics, instead of electromagnetism.

**Theorem .** Given a compact orientable Riemannian manifold with metric  $g$ , the Navier-Stokes equation (132) for fluid with velocity one-form  $u = u(\tau, x)$ , assuming sufficiently regular conditions, are equivalent to a diffusion equation for the vorticity given by (132) with  $u_\tau$  satisfying the Poisson-de Rham eq. (135) for the compressible case and eq. (136) for the incompressible one. The RCW connection on  $M$  generating this process is determined by the metric  $2\nu g$  and a trace-torsion 1-form given by  $-u/2\nu$ .

**Observations** This characterization of NS in terms of a gauge structure, will determine all the random representations for NS which we shall present in this article. We would like to recall that in the gauge theory of gravitation [17] the torsion is related to the translational degrees of freedom present in the Poincaré group, i.e. to the gauging of momentum. Here we find a similar, yet dynamical situation, in which the trace-torsion is related to the velocity and the angular momentum is derived from it simply by considering the vorticity of the fluid. We conclude this chapter noting that with this constructions we can finally give the most general analytical representations for the Navier-Stokes equations using the Brownian motions corresponding to the Navier-Stokes operator [32].

## 12 TURBULENCE AND RCW GEOMETRIES

Turbulence is a universal phenomenae inasmuch viscous fluids are universal. In particular, the role of turbulence in astrophysics has been discussed by several authors [53]. Evidence of turbulence for the origin of galaxy formation has been detected by observations [54]. Gibson has extensively discussed the formation of the gravitational field, galaxies and the Universe from a turbulent fluid [55] and contrasted with advantage the usual approach through the Jeans law. In the present approach in which viscous fluids, gravitational fields, quantum mechanics are all instances of a single geometrical structure and its random counterpart, this seems extremely natural.

In this section we want to introduce a treatment of turbulence which is independent of the particular equations of dynamics and is directly associated with the RCW geometries through the structure of the trace-torsion one-form,  $Q$ , whose conjugate vectorfield, whenever the metric is Minkowski or in an arbitrary Riemannian (i.e. positive-definite) metric is established from the beginning, or still, in the latter case, whenever we have a noise tensor which generates the Riemannian metric through the eq. (15). The clue to this is through the ideas elaborated by R. Kiehn in terms of a classical notion in the theory of differential equations, the topological (also called, the Pfaffian dimension) dimension of  $Q$ . So we consider the set of differential forms on 4-dimensional spacetime given by

$$\{Q, dQ, Q \wedge dQ, dQ \wedge dQ\}, \quad (137)$$

which cannot have higher degree differential forms since  $d(dQ) = 0$  whenever the coefficient functions of  $Q$  are twice differentiable. Then, we follow Kiehn by recalling that the topological dimension of  $Q$  is the minimal number of coordinates in  $M$  on which  $Q$  depend. Thus, if  $dQ = 0$ , then in a connected neighborhood of  $M$ , we can find a differentiable function, say  $f$ , such that  $Q = df$ , i.e.  $Q$  is an exact form in that neighbourhood. Trivially  $dQ = 0$  as well as the higher degree forms of the above set. In this case, it is clear that  $Q$  can be parametrized by a one-dimensional set given by the inverse image by  $f$  of all its values in the real line, and thus for an exact one-form the topological dimension is equal to 1. Let us consider the case that  $Q$  is not exact and furthermore  $Q \wedge dQ = 0$ . By the well known Frobenius integrability theorem, then  $Q$  has topological dimension equal to 2, i.e.  $M$  can be at least locally foliated by two-dimensional submanifolds on which  $Q$  is defined; this corresponds to a reversible dynamics given by the integral flow of  $Q$  that lies in this two-dimensional submanifold. Now assume in the contrary that  $Q \wedge dQ \neq 0$  and furthermore  $dQ \wedge dQ \neq 0$ , so that being this a top degree differential form on  $M$ , in this case  $Q$  has topological dimension equal to 4, and thus equal to the dimension of spacetime. In this case, the integral flow of the drift vectorfield  $\hat{Q}$ , for a positive-definite metric, lies in a four dimensional submanifold. Otherwise, if  $dQ \wedge dQ = 0$ , then  $Q$  has topological dimension equal to 3; in this case, the drift vector field has a flow lying in a three-dimensional submanifold.

In the case of topological dimension equal to 4, we extend Kiehn [47] defining a vector field called the topological torsion by the rule

$$Q \wedge dQ = i_T \text{vol}_g. \quad (138)$$

If we introduce the Hodge star operator  $*$  defined by  $g$ , we have that if  $T^g$  denotes the one-form given by the  $g$  conjugate of the vectorfield  $T$  (i.e.  $T^g = a_\alpha dx^\alpha$  with  $a_\alpha = g_{\alpha\beta} T^\beta$ , where  $T = T^\beta \frac{\partial}{\partial x^\beta}$  is the coordinate expression for  $T$ , then [48]

$$*T^g = i_T \text{vol}_g = Q \wedge dQ, \quad (139)$$

which is Kiehn's topological torsion three-form obtained by duality from  $T^g$ . When  $g$  is the Euclidean metric we retrieve the original definitions [47]. Although the present formulation retrieves the trivial metric case, it is more general since it includes the noise tensor of the Brownian motions having the drift vector field produced by the  $g$ -conjugate of  $Q$ , producing the metric by eq. (15), so in spite the exterior differential operator  $d$ <sup>20</sup> in terms of which define the topological dimension is independent of the background noise, the topological torsion one-form and the topological torsion vector field here introduced, do depend on the metric (and the background noise) through the relations (138) and (139). So the physical meaning of this terms incorporates the background noise tensor, contrarily to Kiehn's approach in which the topological approach is unlinked to noise. In this respect, the presentation here introduced has incorporated the dynamics of the vacuum while in the approach due to Kiehn, the vacuum is absent altogether in the definitions. As it stands, the present constructions are associated to the mean motion of the Brownian motions through their drift

We now compute the four-form  $dQ \wedge dQ$  to obtain

$$dQ \wedge dQ = di_T \text{vol}_g = L_T \text{vol}_g - i_T d \text{vol}_g = L_T \text{vol}_g, \quad (140)$$

which is still equal to  $\Gamma \text{vol}_g$  with  $\Gamma = \text{div}_g T$  (by definition of the divergence, see eq. (4.28) in [48] and therefore

$$dQ \wedge dQ = \Gamma \text{vol}_g \equiv \text{div}_g(T) \text{vol}_g. \quad (141)$$

Thus,  $\Gamma$  is the topological dissipation function. It expresses how the 4-volume defined by the 4-form  $dQ \wedge dQ$  shrinks or expands in terms of the Riemannian

---

<sup>20</sup>We must remark that although the present constructions apply to an arbitrary spacetime trace-torsion one-form, and thus includes the case of a three-dimensional fluid velocity  $u_\tau(x)$  which is also is time-dependent and obeys Navier-Stokes equations, the present exterior differential has an additional time derivative component which is missing in the exterior differential that we encountered when introducing the Navier-Stokes equations. Indeed, when there we wrote  $du_\tau$  this time derivative is absent. The presentation we are giving of the topological dimension, incorporates time as an active parameter for its definition. This is very important, since as we shall see, the topological dimension is related to coherent structures, turbulence, chaos, etc., in a formalization in which statistical considerations are absent completely <sup>21</sup> In this respect, the topological dimension incorporating this active time parameter, coincides with Pensinger and Paine's idea of an active time operator in their study of severe storms formation, which is none-other than the exterior differential in 4D written in a biquaternionic base (see D. Paine and W. Pensinger [52]. It is important to remark that in [52] it is proved that the Navier-Stokes equations in meteorology, map into the Maxwell equation, with a limiting velocity which is not the velocity of light in vacuum; this conception was applied to yield a superconductive model of DNA by Paine and Pensinger. Here the role of nested hierarchical limited space-time domains play an essential role, and the probabilistic approach to quantum mechanics is proposed to be substituted by the many-valued logics due to E. Post. We recall that Kozyrev's conception of time is exactly that of an active operator (this idea was elaborated contemporarily by Prigogine [74]), as we have already discussed above, so what Kiehn is actually doing is presenting a topological theory of structures and further below, of processes, in which time is an active operator for their formation and preservation.

volume  $\text{vol}_g$ . In fact, this 4-form is the Liouville form produced by the symplectic 2-form  $dQ$ , so that here spacetime acquires a symplectic structure, i.e. a nondegenerate closed 2-form on four dimensional spacetime. In a same domain of  $M$  we can actually have different topologies in the sense of Pfaff. We note whenever the topological dimension coincides with the spacetime dimension 4, topological torsion is related to a system whose evolution occupies the 4-dimensional domain, with the possibility that whenever in this domain  $T$  is divergenceless, then the topological dimension of the trace-torsion  $Q$ <sup>22</sup> collapses to 3, thus we have a contact Hamiltonian reversible structure defined by  $Q \wedge dQ$ , corresponding to spacetime defects which are nonequilibrium long lived closed systems, generically spacetime dislocations, or still coherent or stationary structures such as vortices, solitons, dislocations, minimal surfaces, etc. The domains on which the topological dimension of  $Q$  is 4 correspond to thermodynamically open irreversible systems, and in the direction of  $T$ , evolution is irreversible; according to Kiehn, these dynamics correspond to turbulent systems, in our case, associated to the trace-torsion  $Q$  whose conjugate vector field is the drift of the Brownian motions. In the case we have topological dimension equal to 2 or 1, this corresponds to isolated systems in equilibrium. We would like to remark that we can still follow Kiehn presenting a theory of systems based upon the action of vector fields on the trace-torsion  $Q$ , which would then correspond to the evolution of arbitrary processes on the background of the RCW Brownian motions. This description can be elaborated to establish a topological-geometrical approach to the processes in interaction with a universal field, on which we have the action of an active time operator, described by Kozyrev [19, 13, 20], or still the geophysical, ionospheric and solar processes described by Korotaev, Serdyuk and Gorohov [23].

## Acknowledgements

The author would like to express his deep gratitude to Prof. L. Horwitz for discussions on the time parameter and his kind attention to the author's work. Also our gratitude to Vic Christiano for pointing out the work of R. Kiehn on the correspondence between the Schroedinger and Navier-Stokes equations. This work was carried out while at the Mathematics Department, University of Bío Bío, Concepción, Chile, to which we extend our gratitude.

## References

- [1] D. L. Rapoport, On the Unification of Geometric and Random Structures through Torsion Fields: Brownian Motions, Viscous and Magneto-fluid-dynamics,

---

<sup>22</sup>It should not be confused with Kiehn's notation for the heat one-form which in this formalism coincides with  $L_V Q$  for  $V$  a spacetime vector field which is thought as a process acting on the system defined by  $Q$  (noted  $A$  in [47]).

*Foundations of Physics* **35**, no. 7, 1205-1244 (2005).

- [2] D. L. Rapoport, Cartan-Weyl Dirac and Laplacian Operators, Brownian Motions: The Quantum Potential and Scalar Curvature, Maxwell's and Dirac-Hestenes Equations, and Supersymmetric Systems, *Foundations of Physics* **7**, 1383-1431 (2005).
- [3] R. Debever, *The Einstein-Cartan Correspondence*, Royal Academy of Sciences, Belgium, 1983.
- [4] A. Einstein and L. Kauffman, *Annals Maths.*, **56** (1955); Yu Obukhov, *Phys. Letts.* **90 A** (1982),13.
- [5] O. Oron and L.P. Horwitz, Relativistic Brownian Motion as an Eikonal Approximation to a Quantum Evolution Equation , *Foundations of Physics* **33**, 1177 (2003) ; *ibid.* in *Progress in General Relativity and Quantum Cosmology Research*, V. Dvoeglazov (ed.), (Nova Science, Hauppauge, 2004); *ibid.*, *Physics Letts. A* **280**, (2001), 265.
- [6] T. Gill, W.W. Zachary and J. Lindesay, *Foundations of Physics* **31**, no.9, 1299-1355 (2001).
- [7] E. C. Stueckelberg, *Helv. Physica Acta* **14**(1941), 322,588 .
- [8] L.P. Horwitz and C. Piron, *Helv. Physica Acta* **46** (1973), 316; L.P. Horwitz and C. Piron, *Helv. Physica Acta* **66** (1993), 694; M. C. Land, N. Shnerb and L.P. Horwitz, *J. Math. Phys.* **36** (1995), 3263; L.P. Horwitz and N. Shnerb, *Found. of Phys.* **28**(1998), 1509.
- [9] J. Fanchi, *Parametrized Relativistic Quantum Theory*, (Kluwer, Dordrecht,1993).
- [10] M. Trump and W. Schieve *Classical Relativistic Many-Body Dynamics*, (Kluwer, Dordrecht, 1994).
- [11] A. Kyprianidis, *Phys. Rep.* **155**, no.1, (1987),1-27 and references therein.
- [12] R.E. Collins and J.R. Fanchi, *Nuovo Cimento A* **48** (1978), 314; J. Fanchi, *Found.Phys.* **30**, no. 8, (2000), 1161-1189 & **31**, no. 9 (2001), 1267-1285.
- [13] N. Kozyrev, Sources of Stellar Energy and the Theory of the Internal Constitution of Stars, *Progress in Physics* vol.3, pp.65-99 (2005); reprint of the original in Russian.
- [14] E. Nelson, *Quantum Fluctuations*, (Princeton Univ. Press, Princeton, New Jersey , 1985).
- [15] L. P. Hughston, *Proc. Royal Soc. London* **452**, no. 1947, 953-979 (1996).
- [16] S. Adler, and L. Horwitz, *J. Math.Phys.* **41**, 2485 (2000); *ibid.* arXiv:quant-ph/9909026; S. Adler ,*Quantum Theory as an Emergent Phenomenon*, (Cambridge Univ. Press, Cambridge (U.K.), 2004).

- [17] V. de Sabbata, and C. Sivaram, *Spin and Torsion in Gravitation*, (World Scientific, Singapore, 1994); F. Hehl, P. von der Heyde, G. D. Kerlick and J. M. Nestor, *Rev. Mod. Phys.* **15**, 393 (1976).
- [18] T. Schilling, *Geometric Quantum Mechanics*, Ph.D. Thesis, Penn State University (1996).
- [19] N.A. Kozyrev, On the possibility of experimental investigation of the properties of time, in *Time in science and philosophy, Prague, 1971*, p.111-132. Kozyrev N.A., Nasonov V.V., O nekhotoykh svoistvah vremeni, obnaruzhennykh astronomicheskimi nablyudenyami, *Problemy issledovaniya Vselennoi*, **9**, p.76 (1980). (russian), [www.chronos.msu.edu](http://www.chronos.msu.edu).
- [20] A.N. Kozyrev, *Astronomical proofs of the reality of 4D Minkowski Geometry*, in *Manifestations of Cosmic Factors on Earth and Moon*, Moscow-Leningrad, pp.85-93, (1980); [www.chronos.msu.ru](http://www.chronos.msu.ru).
- [21] M. M. Lavrentiev, V. A. Gusev, I. A. Yegonova, M. K. Lutset, S. F. Fominykh, O registratsii istinnogo polozheniya Solntsa, *Doklady Akademii Nauk SSSR*, 1990, v.315, no. 2. (Russian), On the registration of a true position of Sun; M. M. Lavrentiev, I. A. Yegonova, V. G. Medvedev, V. K. Oleinik, S. F. Fominykh, O skanirovanii zvyezdnoy neba datchikom Kozyreva, in *Doklady Akademii Nauk*, **323**, no. 4, (Russian)(1992) (On the scanning of the star sky with Kozyrev's detector.).
- [22] A.P. Levich, Motivations and problems in the studies of time, in *Constructions of Time in Natural Science: On the Way to Understanding the Time Phenomenon; Part 1*, Interdisciplinary Studies. Moscow University Press, Moscow, pp-1-15, (1996); *ibid.*, Time as variability of natural systems: methods of quantitative description of changes and creation of changes by substantial flows, in *Constructions of Time in Natural Science: On the Way to Understanding the Time Phenomenon; Part 1. Interdisciplinary studies*, Moscow University Press, Moscow, 1996, pp. 149-192; *ibid.* A.P. Levich, *Gravitation and Cosmology* **1**, no.3, 237-242 (1995); [www.chronos.msu.edu](http://www.chronos.msu.edu).
- [23] A. N. Korotaev, *On the way to understanding the time phenomenon*, in *The Construction of Time in the Natural Sciences, Part 2*, A. Levich (ed.), pp. 60-74, (World Scientific, Hong-Kong, 1996); *On the possibility of the causal analysis of Geophysical Processes, Geomagnetism and Aeronomy* **32**, no.1, pp.27-33, 1992; and, [www.chronos.msu.edu](http://www.chronos.msu.edu); S.M. Korotaev, V.O. Serdyuk and J.V. Gorohov, Forecast of solar and geomagnetic activity on the macroscopic nonlocality effect, to appear.
- [24] N. Ikeda and S. Watanabe, *Stochastic Differential Equations and Diffusion Processes*, (North-Holland/Kodansha, Amsterdam-Tokyo, 1981).
- [25] P. Malliavin, *Géométrie Différentielle Stochastique*, (Les Presses Univ., Montreal, 1978).
- [26] J.M. Bismut, *Mécanique Analytique*, (Springer LNM **866**, 1982).

- [27] E. Schroedinger *Sitzungsberger Press Akad. Wiss. Math. Phys. Math.*, **144** (1931) and *Ann. I. H. Poincaré* **11** (1932), 300.
- [28] O. Manuel, M.Mozina and H. Ratcliffe, arxiv.org/astro-ph/0511/0511379.
- [29] H. Muller, *Raum und Zeit, special issue 1*, (Ehlers Verlag, 2003), www.globalscaling.de
- [30] H. Muller, *Raum und Zeit, vol. 76* **127**, pp.76-77 (2004); R. Jahn, B. Dunne, G. Bradish, Y. Lettieri and R. Nelson, Mind/Machine Consortium:PortTEG Replication experiments, *J. Scientific Explorations*, **4** no.4, pp.499-555; www.princeton.edu/pear/publist.html; I. Marcikic et al, Long-distance quantum teleportation of qubits at telecommunications wavelengths, *Letters of Nature* **412**, 30, Jan. 2003; A. Furusawa et al, Unconditional Quantum Teleportation, *Science*, Oct. 23, 1998, 706-709, www.its.caltech.edu/qoptics/teleport.html.
- [31] L. Nottale, *Fractal Space-Time and Microphysics*, (World Scientific, Singapore, 1993); *ibid. Astron. Astrophys. Lett.* **315**, L9 (1996); *ibid. Chaos, Solitons & Fractals* **7**, 877 (1996).
- [32] D.L. Rapoport, *Rep. Math.Phys.* **49**, no.1, pp.1-49 (2002), **50**, no.2, pp.211-250 (2002), *Random Operts. Stoch.Eqts.* **11**, no.2, pp.2, pp.109-150 (2003) and **11**, no.4, 351-382 (2003); *ibid. in Trends in Partial Differential Equations of Mathematical Physics, Obidos, Portugal (2003)*, J.F.Rodrigues et al (eds.), Progress in Nonlinear Partial Differential Equations, vol.61, Birkhausser, Boston, (2005); *ibid. in Instabilities and Nonequilibrium Structures VII & VIII*, O. Descalzi et al (eds.), Kluwer Series in Nonlinear Phenomenae and Complex System, Dordrecht, (2004); *ibid. Discrete and Cont. Dynamical Systems, series B, special issue, Third Int.Conf. Differential Eqts. and Dynamical Systems, Kennesaw Univ., May 2000*, 327-336, S. Hu (ed.), (2000).
- [33] R. Kiehn, <http://www22.pair.com/csdc/pdf/bohmplus.pdf>.
- [34] L. Nottale, G. Schumacher & E.T. Lefvre, *Astron. Astrophys.* **361**, 379 (2000).
- [35] V. Fock, *The Theory of Gravitation*, (Pergamon Press, London-New York, 1956).
- [36] M. P.Gaffney, *Annals of Mathematics* **60**, 140-145 (1953.)
- [37] E.B. Davies, *Heat Kernels and spectral theory*, (Cambridge Univ. Press, 1989); S. Rosenberg, *The Laplacian on a Riemannian Manifold*, London Mathematical Society Students Texts, vol. 31, (Cambridge Univ. Press, 1997); R.S.Strichartz, *J.Func.Anal.* **52** no.1, 48-79 (1983).
- [38] M. Nagasawa, *Stochastic Processes in Quantum Physics* (Monographs in Mathematics),(Birkhauser, Boston-Basel , 2000).
- [39] Schechter, *Operator Methods in Quantum Mechanics*, (North-Holland, New York, 1981).



- [40] R.M. Santilli, *Elements of Hadronic Mechanics III*, ( Hadronic Press-Naukova, Palm Harbor-Kiev, 1993); *ibid.Isodual Theory of Antimatter, with Applications to Antigravity, Spacetime Machine and Grand Unification*, (Springer, New York ,2006).
- [41] D. Miller, *Rev.Mod.Phys.*,Vol.5(2), p.203-242, July 1933.
- [42] M. Allais, *Comptes Rendus de L'Academie des Sciences, Paris*, **t. 327, Série II b**, p.1411-1419 (2000) and **t. 1, Série IV**, p.1205-1210 (2000).
- [43] R. Cahill, *Progress in Physics* **4**, pp.73-92 (2006) and references therein .
- [44] M. Pavsic, *The Landscape of Theoretical Physics: A Global View*, (Kluwer, Dordrecht, 2001).
- [45] L. Horwitz and Y. Rabin, quant-ph/0507044, *Lett. Nuovo Cimento* **17** , p.501 (1976). L. Horwitz, On the significance of a recent experiment demonstrating quantum interference in time, quant-ph/0507044; and contribution to the Proceedings of IARD 2006.
- [46] F. Lindner et al, quant-phi/0503165 and *Phys. Rev.Letts.* **95**, 040401, (2005)
- [47] R. Kiehn, *Wakes, Coherence and Turbulent Structures*, (Lulu Publs., 2004). *ibid.* Non-equilibrium Thermodynamics, Vol 1 Non-Equilibrium Systems and Irreversible Processes. *ibid.*Falaco Solitons, Cosmology and the Arrow of Time ... Vol2. Non-Equilibrium Systems and Irreversible Processes.*ibid.* Non Equilibrium Systems and Irreversible Processes Vol. 7 Selected Publications , (Lulu Publs. , 2004).
- [48] T. Frankel, *The Geometry of Physics, An Introduction*, (Cambridge Univ. Press, 2000).
- [49] D.L. Rapoport, in *Group XXI, Physical Applications of Aspects of Geometry, Groups and Algebras, Proceedings of the XXI International Conference on Group Theoretical Methods in Physics, Goslar, Germany, June 1995*, H.Doebner et al (eds.), 446-450, World Scientific, Singapore (1996); *ibid.Advances in Applied Clifford Algebras***8**, no.1, 126-149 (1998).
- [50] L.C. Horwitz, private communication.
- [51] D. Rapoport, *Int. J.Theor. Phys.* **30**no. 11 (1991), 1497. D. Rapoport and S. Sternberg, *Annals of Phys.* **158**, 447 (1984); *ibid*, *Lett. N. Cimento***80A**, 371 (1984).
- [52] D. Paine and W. Pensinger [52] Toward a General Theory of Process (circa May of 1977), <http://www.geocities.com/moonhoabinh/ithapapers/generalpr.html>.
- [53] A G Bershadskii, *Sov. Phys. Uspekhi* **33** (12), 1073-1075, (1990); *Turbulence and Magnetic Fields in Astrophysics (Lecture Notes in Physics)*, E. Falgarone & T. Passot (edts.), (Springer, New York, 2003); Y. Fujita, T. Matsumoto, and K. Wada, *The Astrophysical Journal*, volume 612, part 2 (2004), pages L9L12.

- [54] <http://www.sciencedaily.com/releases/2002/01/020123075605.htm>.turb1.
- [55] C.Gibson, astro-ph/0304441; <http://astro-ph/0304107>;astro-ph/0210583; astro-ph/0110248 .
- [56] D. Rapoport, *Algebras, Groups and Geometries***8**, 1-61 (1980); ibid.
- [57] I. Bialnicky-Birula and J. Mycielsky, *Annals of Physics* **100**, 1611, (1976); see also for numerical solutions J. Kamersberg and A. Zeilinger, *Physica B***151**, 193, (1988).
- [58] D. Rapoport and M. Tilli, Scale Fields as a simplicity principle,in Proceedings of the Third Workshop on Hadronic Mechanics, vol. II (Patras, 1986), *Hadronic J. Suppl.* **6**,no.4, 682-778 (1986).
- [59] C. Castro, J. Mahecha and B. Rodriguez, Nonlinear Quantum Mechanics as a fractal Brownian motion with complex diffusion constant, arXiv:quant-ph/0202026.
- [60] C. Castro and Jorge Mahecha, On Nonlinear Quantum Mechanics, Brownian motions and Fisher Information, *Progress in Physics*, **1**, 38-45 (2006).
- [61] L. Nottale, Fractality field in the Theory of Scale Relativity, *Progress in Physics*, **1**, , 12-16, April (2005).
- [62] D. Rapoport and M. Tilli, *Hadronic Journal***10**, no.1, 25-34 (1987).
- [63] C.Castro, On the coupling constants , Geometric Probability and Complex Domains, *Progress in Physics*,**2**, 46-53 (2006).
- [64] R.M. Santilli, *Foundations of Hadronic Chemistry*,( Kluwer Series in the Fundamental Theories of Physics, Dordrecht-Boston, 2001).
- [65] R.M. Santilli, [arxiv.org/abs/physics/0610263](http://arxiv.org/abs/physics/0610263).
- [66] W. Feller, *Introduction to Probability*, (Addison-Wesley, 1961).
- [67] P. Noyes, *Bit-String Physics, A Finite and Discrete Approach to Natural Philosophy*, J. C. van den Berg (edit.), (World Scientific,Singapore,(2001).
- [68] P.R. Holland, *The quantum theory of motion*, (Cambridge Univestity Press, Cambridge (U.K.), 1994). D.Bohm, *Phys. Rev.* **85**, 166 and 180 (1952); D. Bohm and J.P.Vigier, *Phys. Rev.* **96** (1953).
- [69] A. Kaivarainen, A unified theory of bivacuum, Corpuscle-Wave Duality, Fields and Time, <http://www.karelia.ru/alexk/newarticles/index.html>(2003).
- [70] A.N.Kolmogorov, Zur Umkehrbarkeit der statistischen Naturgesetze, *Math. Annalen* **113** (1937), 776-772.
- [71] B. de Witt, Quantum Field Theory in Curved Space-Time, *Phys. Rep. C* **19**, no.6 (1975), 295-357. G.W. Gibbons, in *General Relativity, An Einstein Centenary Survey*, S.W. Hawking and W. Israel, (Cambridge Univ. Press, Cambridge, 1979); N.D. Birrell and P.C.W.Davies, *Quantum Field Theories in Curved Space*.

- [72] F. Langouche, D. Roenkarts and E. Tiraepgui, *Functional Integration and Semi-classical Expansions*; (Reidel, Dordrecht 1981).
- [73] S. Albeverio et al., *J.Math.Phys.* **18**, 907 (1977) and Stochastic Methods in Physics, *Math. Phys.Rep.* **77**, in K.D. Elworthy and de C. Witt-Morette, (eds.), no.3, (1977). See also F.Guerra contribution in the last reference. Kleinert H. Kleinert, *Path integrals in Quantum Mechanics, Statistics and Polymer Physics*, (World Scientific, Singapore, 1991).
- [74] I. Prigogine, *From Being to Becoming*, (Holden Day, San Francisco, 1991).
- [75] M.Pitkanen, see the first chapter of the present volume and references therein.
- [76] F. Smarandache, see references in the contributions to this volume.
- [77] W. Rodrigues and E. Capelas de Oliveira, *The Many Faces of the Maxwell, Dirac and Einstein equations*, (Springer,Berlin, in press, 2007).
- [78] D. Rapoport, W. Rodrigues, Q. de Souza and J.Vaz, *Algebras, Groups and Geometries* **11**, 25-35 (1995).
- [79] J. Vaz Jr. and W.A.Rodrigues, *Int.. J.Theor.Phys.* **32** 945-949 (1995); W. Rodrigues and J. Vaz, in R.Delanghe (ed.), *Clifford Algebras and their Applications in Mathematical Physics*, Proceedings of the III Workshop, (Kluwer,Dordrecht, 1993).
- [80] D. Rapoport, Torsion Fields, Cartan-Weyl Space-Time and State-Space Quantum Geometries and their Brownian Motions, to appear , *Foundations of Physics* **37** (2007).

**VISCOUS AND MAGNETO FLUID-DYNAMICS, TORSION FIELDS,  
AND BROWNIAN MOTIONS REPRESENTATIONS ON COMPACT MANIFOLDS  
AND THE RANDOM SYMPLECTIC INVARIANTS**

**Diego L. Rapoport**

**Dep. Sciences and Technology, Univ. Nac. de Quilmes  
Bernal, Buenos Aires, Argentina**

**Abstract:** We reintroduce the Riemann-Cartan-Weyl geometries with trace torsion and their associated Brownian motions on spacetime to extend them to Brownian motions on the tangent bundle and exterior powers of them. We characterize the diffusion of differential forms, for the case of manifolds without boundaries and the smooth boundary case. We present implicit representations for the Navier-Stokes equations (NS) for an incompressible fluid in a smooth compact manifold without boundary as well as for the kinematic dynamo equation (KDE, for short) of magnetohydrodynamics. We derive these representations from stochastic differential geometry, unifying gauge theoretical structures and the stochastic analysis on manifolds (the Ito-Elworthy formula for differential forms. From the diffeomorphism property of the random flow given by the scalar lagrangian representations for the viscous and magnetized fluids, we derive the representations for NS and KDE, using the generalized Hamilton and Ricci random flows (for arbitrary compact manifolds without boundary), and the gradient diffusion processes (for isometric immersions on Euclidean space of these manifolds). We solve implicitly this equations in 2D and 3D. Continuing with this method, we prove that NS and KDE in any dimension other than 1, can be represented as purely (geometrical) noise processes, with diffusion tensor depending on the fluid's velocity, and we represent the solutions of NS and KDE in terms of these processes. We discuss the relations between these representations and the problem of infinite-time existence of solutions of NS and KDE. We finally discuss the relations between this approach with the low dimensional chaotic dynamics describing the asymptotic regime of the solutions of NS. We present the random symplectic theory for the Brownian motions generated by these Riemann-Cartan-Weyl geometries, and the associated random Poincaré-Cartan invariants. We apply this to the Navier-Stokes and kinematic dynamo equations. In the case of 2D and 3D, we solve the Hamiltonian equations.

**MSC numbers** 60J60, 60H10, 35Q30, 64H30, 58G03, 58G32, 76M35, 53Z05.

# 1 Introduction.

In a separate chapter of this book, we have presented the relations between certain spacetime geometries, Brownian motions and non-relativistic quantum mechanics. We also touched briefly on the Navier-Stokes equations for viscous fluid-dynamics and the associated problem of describing turbulence in topological terms in analyzing the Pfaffian (topological dimension) of the trace-torsion one-form. But in that article, we stopped short of giving analytical representations for the Navier-Stokes equations. In that chapter it appeared that contrary to common belief, torsion fields are all pervasive, in the sense that the Schroedinger wave function is a torsion field generator through the logarithmic differential of it. Furthermore, another remarkable torsion field appeared to be the velocity one-form for a viscous fluid obeying the Navier-Stokes equations. We also discussed shortly the relations between the Schroedinger and Navier-Stokes equations, and that the Brownian motions which will constitute the virtual paths for the fluids random particles, sustain a probability measure which is none other than the enstrophy of the fluid, and thus the square of the vorticity function (for the case of spatial 2D case) becomes the Born probability amplitude of the Navier-Stokes equations.

The purpose of this chapter is two-fold: To start with, to give implicit random representations for the solutions of the Navier-Stokes equation for an incompressible fluid (NS, for short in the following) and for the kinematic dynamo problem of magnetohydrodynamics, in several instances; firstly, on an arbitrary compact orientable smooth manifold (without boundary), following our presentation in [58,59]; further in the case in which the manifold is isometrically embedded in Euclidean space [58,66], from which we deduce the expressions for Euclidean space itself, and finally representations of NS as purely noise equations.

Secondly, to present as a basis for these representations, the gauge-theoretical structures of Brownian motion theory and the stochastic analysis associated to them. Thus, the method of integration we shall apply for our objectives stems from stochastic differential geometry, i.e. the gauge theory of Brownian processes in smooth manifolds and Euclidean space developed in the pioneering works by Ito [15], Eells and Elworthy [13], P. Malliavin [11] and further elaborated by Elworthy [12], Ikeda and Watanabe [14], P. Meyer [40], and Rogers and Williams [37]. Associated to these geometrical structures which can be written in terms of the Cartan calculus on manifolds of classical differential geometry, we shall present the rules of stochastic analysis which describe the transformation of differential forms along the paths of generalized Brownian motion generated by these geometries, setting thus the method for the integration of evolution equations for differential forms; this is the well known martingale problem approach for the integration of partial differential equations on manifolds [30].

While classical Hamiltonian systems with finite degrees of freedom may appear to have a random behavior, in fluid dynamics it is known that the

2D Euler equation for an inviscid fluid is a hamiltonian system with infinite degrees of freedom supporting as well infinite conserved quantities; such a system appears to be non-random and the approach, pioneered by Arnold and further elaborated by Ebin and Marsden, is a blending of global analysis and symplectic geometry [9,56,70]. The situation is radically different in the case of a viscous fluid described by the NS. In this case, there is a second-order partial derivative associated to the kinematical viscosity, which points out to the fact that there is a diffusion term, which can be thought as related to a Brownian motion. Thus in the viscous case, there is from the very beginning a random element. While in the Euler case the group of interest is the group of (Riemannian) volume preserving diffeomorphisms, it will turn out in the course of these studies, that there is an active group of *random* diffeomorphisms which represent the Lagrangian random flow of the viscous fluid particles. In this case, when there is a non-constant diffusion tensor describing the local amplification of noise, these diffeomorphisms do not preserve the volume measure, contributing at a dynamical level -as it will turn out- to the complicated topology of turbulent and magnetized flows [56].

The essential role of randomness in Fluid Dynamics appears already at an experimental level. The analysis of the velocimetry signal of a turbulent fluid shows that its velocity is a random variable, even though that the dynamics is ruled by NS [8]. The concept of a turbulent fluid as a stochastic process was first proposed by Reynolds [16], who decomposed the velocity into mean velocity plus fluctuations. The Reynolds approach is currently used in most numerical simulations of turbulent fluids in spite of the fact that it leads to unsurmountable non-closure problems of the transport equations.; see Lumley [18], Mollo and Christiansen [38]. Furthermore, the Reynolds decomposition is non invariant alike the usual decomposition into drift and white noise perturbation in the non-invariant treatment of diffusion processes. Other treatments of stochasticity in turbulence were advanced from the point of view of Feynman path integrals, as initiated by Monin and Yaglom [17]. From the point of view of diffusion processes, invariant measures for stochastic modifications of the Navier-Stokes equations on euclidean domains, have been constructed by Vishik and Fursikov [36] and Cruzeiro and Albeverio [42]. (It is important to remark that the existence of an invariant measure for NS as a *classical* dynamical system is the starting point of the classical dynamical systems approach to turbulence; see Ruelle [48].) Contemporary investigations develop the relations between randomness and the many-scale structure of turbulence which stems from the Kolmogorov theory as presented by Fritsch[8] and Lesieur [3], and apply the renormalization group method; see Orszag [19].

A completely new line of research followed from the understanding of the fundamental importance of the vorticity (already stressed by Leonardo da Vinci) in the self-organization of turbulent fluids, which was assessed by numerical simulations by Lesieur [3,4], and theoretically by Majda [39] and Chorin [1]. It was found that NS on Euclidean domains yields a diffusion equation for the

vorticity which becomes a source for the velocity through the Poisson equation: Solving the latter equation, we can obtain an expression for the fluids velocity in 2D. This observation was the starting point for the random vortex method in Computational Fluid Mechanics largely pioneered by Chorin, and lead to momentous suces in numerical implementations for viscous fluids [1,2,6]. This conception lead to apply methods of statistical mechanics (as originally proposed by Onsager [20]) to study the complex topology of vortex dynamics and to relate this to polymer dynamics [1]. In the random vortex method a random lagrangian representation for the position of the incompressible fluid particles was proposed. Consequently, NS (heat equation) for the vorticity was integrated only for fluids in 2D flat space (implicit to this is the martingale problem approach quoted above); see Chorin [1,2]. The difficulty for the exact integration in the general case apparently stems from the fact that while in dimension 2 the vorticity 2-form can be identified with a density and then the integration of NS for the vorticity follows from the application of the well known Ito formula for scalar fields, in the case of higher dimension this identification is no longer valid and an Ito formula for 2-forms is required to carry out the integration in the case of manifolds. This formula only recently became available in the works by Elworthy [27] and Kunita [24], in the context of the theory of random flows on smooth manifolds, largely developed by Baxendale [55,77,78,79,80].

The importance of a Stochastic Differential Geometry treatment of the Navier-Stokes equation on a smooth  $n$ -manifold  $M$  or in Euclidean space, stems from several fundamental facts which are keenly interwoven. For a start, it provides an intrinsic geometrical characterization of diffusion processes of differential forms which follows from the characterizations of the laplacians associated to non-Riemannian geometries with torsion of the trace type, as the infinitesimal generators of the diffusions. In particular, this will allow to obtain a new way of writing NS in terms of these laplacians acting on differential one-forms (velocities) and two-forms (vorticities). Furthermore, these diffusion processes of differential forms, are constructed starting from the scalar diffusion process which under Hoelder continuity or Sobolev regularity conditions, yields a time-dependant random diffeomorphism of  $M$  which will represent the Lagrangian trajectories for the fluid particles position. This diffeomorphic property will allow us to use the Ito formula for differential forms (following the presentation due to Elworthy) as the key instrument for the integration of NS. Thus, it is the knowledge of the rules of stochastic analysis what sets the martingale problem approach to the solution of NS when he have transformed it to an equivalent system which is essentially the heat equation for the vorticity and the Poisson-de Rham equation for the velocity with source derived from the velocity, the latter admitting a random integration which generalizes the well known Biot-Savart formula. <sup>1</sup> To keep the methodology that steers this article, as clear as possi-

---

<sup>1</sup>The geometrical structures on which the gauge-theoretical foundations of Brownian motion are introduced, were originally found in gauge theories of gravitation, including not only

ble, we shall present rather extensively the relations between gauge-theoretical structures and stochastic analysis, keeping in mind that they are unknown to the mathematical-physics community, at large. Thus, Sections II to V will present the linear connections of Riemann-Cartan-Weyl, their laplacians and the random flows generated by them. Then, in Sections VI to XI we shall deal with NS and the kinematic dynamo equations, giving the random representations for their solutions, for arbitrary compact manifolds and for manifolds isometrically embedded in Euclidean space, from which we shall deduce the solutions in  $2D$  and  $3D$  for both equations. In Section XII we shall return to the method, discussing again the relation between connections and stochastic analysis, to give most remarkable driftless representations for diffusion processes on any manifold with dimension other than 1, i.e. the representation of the invariant diffusion operator in terms of a purely (geometrical) noise operator, which is a reduction of a more general recent result due to Elworthy-LeJan-Li [71]. This article closes with the application of this, in Section XIII, to yield the driftless representations for NS and the kinematic dynamo equations, thus proving that the non-linearity of NS can be incorporated to the diffusion tensor, yielding a non-linear purely noise equation. This might be conceived as the completion of the theoretical treatment of an historical sequence, starting from coherent geometrical vortex structures (whose dynamics is described by a RCW connection, i.e. by a geometry) reaching to the empirically verified noise of viscous fluids in turbulent regime, in which the noise admits a geometrical representation itself.

## 2 Riemann-Cartan-Weyl Geometry of Diffusions

The objective of this section is to show that the invariant definition of a "heat" (Fokker-Planck) operator requires the introduction of linear connections of a certain type. This gauge-theoretical characterization, together with stochastic analysis, turns out to be the very the basis for the construction of diffusion processes, either on smooth manifolds or in Euclidean space.

Let us consider for a start, a smooth  $n$ -dimensional compact orientable manifold  $M$  (without boundary), on which we shall consider a second-order smooth differential operator  $L$ . On a local coordinate system,  $(x^\alpha)$ ,  $\alpha = 1, \dots, n$ ,  $L$  is written as

$$L = \frac{1}{2}g^{\alpha\beta}(x)\partial_\alpha\partial_\beta + B^\alpha(x)\partial_\alpha + c(x). \quad (1)$$

From now on, we shall fix this coordinate system, and all local expressions shall be written in it.

---

translational degrees of freedom, but additionally spinor fields [46]; furthermore, it appeared in the formulation of the classical mechanics of spinning particles submitted to exterior gravitational fields [57], which spares the use of hamiltonean and lagrangean formalisms.



Although formally, there is no restriction as to the nature of  $M$ , we are really thinking on a  $n$ -dimensional space (or space-time) manifold, and **not** in a phase-space manifold of a dynamical system.

The *principal symbol*  $\sigma$  of  $L$ , is the section of the bundle of real bilinear symmetric maps on  $T^*M$ , defined as follows: for  $x \in M$ ,  $p_i \in T_x^*M$ , take  $C^2$  functions,  $f_i : M \rightarrow R$  with  $f_i(x) = 0$  and  $df_i(x) = p_i$ ,  $i = 1, 2$ ; then,

$$\sigma(x)(p_1, p_2) = L(f_1 f_2)(x). \quad (2)$$

Note that  $\sigma$  is well defined, i.e., it is independent of the choice of the functions  $f_i$ ,  $i = 1, 2$ .  $T^*M$  is, of course, the cotangent manifold,  $T_x^*M$  a fiber on  $x \in M$ .

If  $L$  is locally as in (1), then  $\sigma$  is locally represented by the matrix  $(g^{\alpha\beta})$ . We can also view  $\sigma$  as a section of the bundle of linear maps  $L(T^*M, TM)$ , or as a section of the bundle  $TM \otimes TM$ , or still as a bundle morphism from  $T^*M$  to  $TM$ . If  $\sigma$  is a bundle isomorphism, it induces a Riemannian structure  $g$  on  $M$ ,  $g : M \rightarrow L(TM, TM)$ :

$$g(x)(v_1, v_2) := \langle \sigma(x)^{-1} v_1, v_2 \rangle_x,$$

for  $x \in M$ ,  $v_1, v_2 \in T_x M$ . Here,  $\langle \cdot, \cdot \rangle_x$  denotes the natural duality between  $T_x^*M$  and  $T_x M$ . Locally,  $g(x)$  is represented by the matrix  $\frac{1}{2}(g^{\alpha\beta}(x))^{-1}$ . Consider the quadratic forms over  $M$  associated to  $L$ , defined as

$$Q_x(p_x) = \frac{1}{2} \langle p_x, \sigma_x(p_x) \rangle_x,$$

for  $x \in M$ ,  $p_x \in T_x^*M$ . Then, with the local representation (1) for  $L$ ,  $Q_x$  is represented as  $\frac{1}{2}(g^{\alpha\beta}(x))$ . Then,  $L$  is an elliptic (semi-elliptic) operator whenever for all  $x \in M$ ,  $Q_x$  is positive-definite (non-negative definite). We shall assume in the following that  $L$  is an elliptic operator. In this case,  $\sigma$  is a bundle isomorphism and the metric  $g$  is actually a Riemannian metric. Notice, as well, that  $\sigma(df) = \text{grad } f$ , for any  $f : M \rightarrow R$  of class  $C^2$ , where  $\text{grad}$  denotes the Riemannian gradient.

We wish to give an intrinsic description of  $L$ , i.e. a description independent of the local coordinate system. This is the essential prerequisite of covariance.

For this, we shall introduce for the general setting of the discussion, an arbitrary connection on  $M$ , whose covariant derivative we shall denote as  $\nabla$ . We remark here that  $\nabla$  will *not* be the Levi-Civita connection associated to  $g$ ; we shall precise this below. Let  $\sigma(\nabla)$  denote the second-order part of  $L$ , and let us denote by  $X_0(\nabla)$  the vector field on  $M$  given by the first-order part of  $L$ . Finally, the zero-th order part of  $L$  is given by  $L(1)$ , where 1 denotes the constant function on  $M$  equal to 1. We shall assume in the following, that  $L(1)$  vanishes identically.

Then, for  $f : M \rightarrow R$  of class  $C^2$ , we have

$$\sigma(\nabla)(x) = \frac{1}{2} \text{trace}(\nabla^2 f)(x) = \frac{1}{2} (\nabla df)(x), \quad (3)$$

where the trace is taken in terms of  $g$ , and  $\nabla df$  is thought as a section of  $L(T^*M, T^*M)$ . Also,  $X_0(\nabla) = L - \sigma(\nabla)$ . If  $\Gamma_{\beta\gamma}^\alpha$  is the local representation for the Christoffel symbols of the connection, then the local representation of  $\sigma(\nabla)$  is:

$$\sigma(\nabla)(x) = \frac{1}{2}g^{\alpha\beta}(x)(\partial_\alpha\partial_\beta + \Gamma_{\alpha\beta}^\gamma(x)\partial_\gamma), \quad (4)$$

and

$$X_0(\nabla)(x) = B^\alpha(x)\partial_\alpha - \frac{1}{2}g^{\alpha\beta}(x)\Gamma_{\alpha\beta}^\gamma\partial_\gamma. \quad (5)$$

If  $\nabla$  is the Levi-Civita connection associated to  $g$ , which we shall denote as  $\nabla^g$ , then for any  $f : M \rightarrow R$  of class  $C^2$ :

$$\sigma(\nabla^g)(df) = \frac{1}{2}\text{trace}((\nabla^g)^2 f) = \frac{1}{2}\text{trace}(\nabla^g df) = -1/2\text{div}_g \text{grad } f = 1/2\Delta_g f. \quad (6)$$

Here,  $\Delta_g$  is the Levi-Civita laplacian operator on functions; locally it is written as

$$\Delta_g = g^{-1/2}\partial_\alpha((g^{1/2}g^{\alpha\beta}\partial_\beta); \quad g = \det(g_{\alpha\beta}), \quad (7)$$

and  $\text{div}_g$  is the Riemannian divergence operator on vector fields  $X = X^\alpha(x)\partial_\alpha$ :

$$\text{div}_g(X) = -g^{-1/2}\partial_\alpha(g^{1/2}X^\alpha). \quad (8)$$

Note the relation we already have used in eqt. (6) and will be used repeatedly; namely:

$$\text{div}_g(X) = -\delta\tilde{X}, \quad (9)$$

where  $\delta$  is the co-differential operator (see (23) below), and  $\tilde{X}$  is the one-form conjugate to the vector field  $X$ , i.e.  $\tilde{X}_\alpha = g_{\alpha\beta}X^\beta$ .

We now take  $\nabla$  to be a Cartan connection with torsion [10,46], which we additionally assume to be compatible with  $g$ , i.e.  $\nabla g = 0$ . Then  $\sigma(\nabla) = \frac{1}{2}\text{trace}(\nabla^2)$ . Let us compute this. Denote the Christoffel coefficients of  $\nabla$  as  $\Gamma_{\beta\gamma}^\alpha$ ; then,

$$\Gamma_{\beta\gamma}^\alpha = \left\{ \begin{matrix} \alpha \\ \beta\gamma \end{matrix} \right\} + 1/2K_{\beta\gamma}^\alpha, \quad (10)$$

where the first term in (10) stands for the Christoffel Levi-Civita coefficients of the metric  $g$ , and

$$K_{\beta\gamma}^\alpha = T_{\beta\gamma}^\alpha + S_{\beta\gamma}^\alpha + S_{\gamma\beta}^\alpha, \quad (11)$$

is the cotorsion tensor, with  $S_{\beta\gamma}^\alpha = g^{\alpha\nu} g_{\beta\kappa} T_{\nu\gamma}^\kappa$ , and  $T_{\beta\gamma}^\alpha = \Gamma_{\beta\gamma}^\alpha - \Gamma_{\gamma\beta}^\alpha$  the skew-symmetric torsion tensor.

Let us consider the Laplacian operator associated with this Cartan connection, defined -in extending the usual definition- by

$$H(\nabla) = 1/2\text{trace}\nabla^2 = 1/2g^{\alpha\beta}\nabla_\alpha\nabla_\beta, \quad (12)$$

where  $\nabla$  stands for the covariant derivative operator with respect to  $\Gamma$ ; then,  $\sigma(\nabla) = H(\nabla)$ . A straightforward computation shows that that  $H(\nabla)$  only depends in the trace of the torsion tensor and  $g$ :

$$H(\nabla) = 1/2\Delta_g + g^{\alpha\beta}Q_\beta\partial_\alpha \equiv H_0(g, Q), \quad (13)$$

with  $Q = T_{\nu\beta}^\nu dx^\beta$ , the trace-torsion one-form.

Therefore, for the Cartan connection  $\nabla$  defined in (10), we have that

$$\sigma(\nabla) = \frac{1}{2}\text{trace}(\nabla^2) = \frac{1}{2}\Delta_g + \hat{Q}, \quad (14)$$

with  $\hat{Q}$  the vector-field conjugate to the 1-form  $Q$ :  $\hat{Q}(f) = \langle Q, \text{grad } f \rangle$ ,  $f : M \rightarrow R$ . In local coordinates,

$$\hat{Q}^\alpha = g^{\alpha\beta}Q_\beta.$$

We further have:

$$X_0(\nabla) = B - \frac{1}{2}g^{\alpha\beta}\left\{\begin{matrix} \gamma \\ \alpha\beta \end{matrix}\right\}\partial_\gamma - \hat{Q}, \quad (15)$$

Therefore, the invariant decomposition of  $L$  is

$$\frac{1}{2}\text{trace}(\nabla^2) + X_0(\nabla) = \frac{1}{2}\Delta_g + b, \quad (16)$$

with

$$b = B - \frac{1}{2}g^{\alpha\beta}\left\{\begin{matrix} \gamma \\ \alpha\beta \end{matrix}\right\}\partial_\gamma. \quad (17)$$

Notice that (15) can be thought as arising from a gauge transformation:  $\tilde{b} \rightarrow \tilde{b} - Q$ , with  $\tilde{b}$  the 1-form conjugate to  $b$ .

If we take for a start  $\nabla$  with Christoffel symbols of the form

$$\Gamma_{\beta\gamma}^\alpha = \left\{\begin{matrix} \alpha \\ \beta\gamma \end{matrix}\right\} + \frac{2}{(n-1)}\{\delta_\beta^\alpha Q_\gamma - g_{\beta\gamma} Q^\alpha\} \quad (18)$$

with

$$Q = \tilde{b}, \quad \text{i.e.} \quad \hat{Q} = b, \quad (19)$$

we have

$$X_0(\nabla) = 0$$

and

$$H_0(g, Q) = \sigma(\nabla) = \frac{1}{2} \text{trace}(\nabla^2) = \frac{1}{2} \text{trace}((\nabla^g)^2) + \hat{Q} = \frac{1}{2} \Delta_g + b. \quad (20)$$

Therefore, for  $\nabla$  as in (18) we obtain a gauge theoretical invariant representation for  $L$  given by an operator whose first order term is incorporated into its symbol:

$$L = H(\nabla) = \frac{1}{2} \nabla^2 = \sigma(\nabla) = \frac{1}{2} \text{trace}((\nabla^g)^2) + \hat{Q} = H_0(g, Q).$$

or more shortly, the expression we shall follow along this article

$$H_0(g, Q) = \frac{1}{2} \text{trace}((\nabla^g)^2) + \hat{Q}. \quad (21)$$

where  $\hat{Q}$  is the vectorfield given by the  $g$ -conjugate of the one-form  $Q = Q_\beta dx^\beta$ , i.e. with components  $\hat{Q}^\alpha = g^{\alpha\beta} Q_\beta$ .

The restriction we have placed in  $\nabla$  to be as in (18), i.e. only the trace component of the irreducible decomposition of the torsion tensor is taken, is due to the fact that all other components of this tensor do not appear at all in the laplacian of (the otherwise too general)  $\nabla$ . In the particular case of dimension 2, this is automatically satisfied. In the case we actually have assumed that  $g$  is Riemannian, the expression (21) is the most general invariant laplacian (with zero potential term) acting on functions defined on a smooth manifold. This restriction, will allow us to establish a one-to-one correspondence between Riemann-Cartan connections of the form (18) with (generalized Brownian) diffusion processes. These metric compatible connections we shall call RCW geometries (short for Riemann-Cartan-Weyl), since the trace-torsion is a Weyl 1-form [10]. Thus, these geometries do not have the historicity problem which lead to Einstein's rejection of the first gauge theory ever proposed by Weyl.

To obtain the most general form of the RCW laplacian, we only need to apply to the trace-torsion one-form the most general decomposition of one-forms on a smooth compact manifold. This amounts to give the constitutive equations of the particular theory of fluctuations under consideration on the manifold  $M$ ; see [22,26,49]. The answer to this problem, is given by the well known de Rham-Kodaira-Hodge theorem of global analysis (in Fluid Mechanics it is known with the acronym Helmholtz-Hodge [5]), which we present now.

We consider the Hilbert space of square summable  $\omega$  of smooth differential forms of degree  $k$  on  $M$ , with respect to  $\text{vol}_g$ . We shall denote this space as  $L^{2,k}$ . The inner product is

$$\langle\langle \omega, \phi \rangle\rangle := \int_M \langle \omega(x), \phi(x) \rangle \text{vol}_g(x), \quad (22)$$

where the integrand is given by the multiplication between the components  $\omega_{\alpha_1 \dots \alpha_k}$  of  $\omega$  and the conjugate tensor:  $g^{\alpha_1 \beta_1} \dots g^{\alpha_k \beta_k} \phi_{\beta_1 \dots \beta_k}$ ; alternatively, we can write in a coordinate independent way:  $\langle \omega(x), \phi(x) \rangle \text{vol}_g = \omega(x) \wedge * \phi(x)$ , with  $*$  the Hodge star operator, for any  $\omega, \phi \in L^{2,k}$ .

The de Rham-Kodaira-Hodge operator on  $L^{2,k}$  is defined as

$$\Delta_k = -(d + \delta)^2 = -(d\delta + \delta d), \quad (23)$$

where  $\delta$  is the formal adjoint defined on  $L^{2,k+1}$  of the exterior differential operator  $d$  defined on  $L^{2,k}$ :

$$\langle\langle \delta\phi, \omega \rangle\rangle = \langle\langle \phi, d\omega \rangle\rangle,$$

for  $\phi \in L^{2,k+1}$  and  $\omega \in L^{2,k}$ . Then,  $\delta^2 = 0$  follows from  $d^2 = 0$ .

Let  $R : (TM \oplus TM) \oplus TM \rightarrow TM$  be the (metric) curvature tensor defined by:  $(\nabla^g)^2 Y(v_1, v_2) = (\nabla^g)^2 Y(v_2, v_1) + R(v_1, v_2)Y(x)$ . From the Weitzenbock formula [14] we have the decomposition of  $\Delta_1$  into the Laplace-Beltrami term and a Weitzenbock term

$$\Delta_1 \phi(v) = \text{trace} (\nabla^g)^2 \phi(-, -) - Ric_x(v, \hat{\phi}_x),$$

for  $v \in T_x M$  and  $Ric_x(v_1, v_2) = \text{trace} \langle R(-, v_1)v_2, - \rangle_x$ . Then,  $\Delta_0 = (\nabla^g)^2 = \Delta_g$  so that in the case of  $k = 0$ , the de Rham-Kodaira operator coincides with the Laplace-Beltrami operator on functions.

The de Rham-Kodaira-Hodge theorem states that  $L^{2,1}$  admits the following invariant decomposition. Let  $\omega \in L^{2,1}$ ; then,

$$\omega = d f + A_1 + A_2, \quad (24)$$

where  $f : M \rightarrow R$  is a smooth function on  $M$ ,  $A_1$  is a co-closed smooth 1-form:  $\delta A_1 = -div_g \hat{A}_1 = 0$ , and  $A_2$  is a co-closed and closed smooth 1-form:

$$\delta A_2 = 0, dA_2 = 0. \quad (25)$$

Otherwise stated,  $A_2$  is an harmonic one-form, i.e.

$$\Delta_1 A_2 = 0. \quad (26)$$

Furthermore, this decomposition is orthogonal in  $L^{2,1}$ , i.e.:

$$\langle\langle df, A_1 \rangle\rangle = \langle\langle df, A_2 \rangle\rangle = \langle\langle A_1, A_2 \rangle\rangle = 0. \quad (27)$$

**Remark 1.** Note that  $A_1 + A_2$  is itself a co-closed one-form. If we consider an augmented configuration space  $R \times M$  for an incompressible fluid, the de Rham-Kodaira-Hodge is applied to the fluid's velocity described by a time-dependant 1-form satisfying NS. If we consider instead a four-dimensional Lorentzian manifold  $M$  provided with a Dirac-Hestenes spinor operator field

(i.e. a section of the spinor bundle over  $M$ ), one needs the whole decomposition (24) associated to an invariant density  $\rho$  of the diffusion (i.e. a solution of the equation  $H_0(g, Q)^\dagger \rho = 0$ ) to describe two electromagnetic potentials such that when restricted to the spin-plane of the DHSOF, they enforce the equivalence between the Dirac-Hestenes equation for the DHSOF on a manifold provided with a RCW connection, and the free Maxwell equation on the Lorentzian space-time [26,60].

### 3 Generalized Laplacians on Differential Forms

Consider the family of zero-th order differential operators acting on smooth  $k$ -forms, i.e. differential forms of degree  $k$  ( $k = 0, \dots, n$ ) defined on  $M$ :

$$H_k(g, Q) := 1/2\Delta_k + L_{\hat{Q}}, \quad (28)$$

Furthermore, the second term in (28) denotes the Lie-derivative with respect to the vectorfield  $\hat{Q}$ . Recall that the Lie-derivative is independent of the metric: for any smooth vectorfield  $X$  on  $M$

$$L_X = i_X d + di_X, \quad (29)$$

where  $i_X$  is the interior product with respect to  $X$ : for arbitrary vectorfields  $X_1, \dots, X_{k-1}$  and  $\phi$  a  $k$ -form defined on  $M$ , we have  $(i_X \phi)(X_1, \dots, X_{k-1}) = \phi(X, X_1, \dots, X_{k-1})$ . Then, for  $f$  a scalar field,  $i_X f = 0$  and

$$L_X f = (i_X d + di_X) f = i_X df = g(\tilde{X}, df) = X(f). \quad (30)$$

where  $\tilde{X}$  denotes the 1-form associated to a vectorfield  $X$  on  $M$  via  $g$ . We shall need later the following identities between operators acting on smooth  $k$ -forms, which follow easily from algebraic manipulation of the definitions:

$$d\Delta_k = \Delta_{k+1}d, \quad k = 0, \dots, n, \quad (31)$$

and

$$\delta\Delta_k = \Delta_{k-1}\delta, \quad k = 1, \dots, n, \quad (32)$$

and finally, for any vectorfield  $X$  on  $M$  we have that  $dL_X = L_X d$  and therefore

$$dH_k(g, Q) = H_{k+1}(g, Q)d, \quad k = 0, \dots, n. \quad (33)$$

In (28) we retrieve for scalar fields ( $k = 0$ ) the operator  $H_0(g, Q)$  defined in (21).

**Proposition 1.** Assume that  $g$  is non-degenerate. There is a one-to-one mapping

$$\nabla \rightsquigarrow H_k(g, Q) = 1/2\Delta_k + L_{\hat{Q}}$$

between the space of  $g$ -compatible affine connections  $\nabla$  with Christoffel coefficients of the form

$$\Gamma_{\beta\gamma}^{\alpha} = \left\{ \begin{matrix} \alpha \\ \beta\gamma \end{matrix} \right\} + \frac{2}{(n-1)} \{ \delta_{\beta}^{\alpha} Q_{\gamma} - g_{\beta\gamma} Q^{\alpha} \} \quad (34)$$

and the space of elliptic second order differential operators on  $k$ -forms ( $k = 0, \dots, n$ ) with zero potential term (other than the Weitzenbock term [14]).

## 4 Riemann-Cartan-Weyl Connections and the Laplacians for Differential Forms

In this section we shall construct the diffusion processes for scalar fields.

In the following we shall further assume that  $Q = Q(\tau, x)$  is a time-dependant 1-form, so that we have a time-dependant RCW connection on  $M$ , which we think of as a space manifold. The stochastic flow associated to the diffusion generated by  $H_0(g, Q)$  has for sample paths the continuous curves  $\tau \mapsto x_{\tau} \in M$  satisfying the Ito invariant non-degenerate s.d.e. (stochastic differential equation)

$$dx_{\tau} = X(x_{\tau})dW_{\tau} + \hat{Q}(\tau, x_{\tau})d\tau. \quad (35)$$

In this expression,  $\hat{Q}$  is the  $g$ -conjugate of  $Q$ , the diffusion tensor  $X = (X_{\beta}^{\alpha}(x))$  is a linear surjection  $X(x) : R^m \rightarrow T_x M$  satisfying  $X_{\nu}^{\alpha} X_{\nu}^{\beta} = g^{\alpha\beta}$ , and  $\{W(\tau), \tau \geq 0\}$  is a standard Wiener process on  $R^n$ . Thus  $\langle W_{\tau} \rangle = 0$  and  $\langle W_{\tau}^i W_{\tau}^j \rangle = \delta_{ij} \tau$ , where  $\langle - \rangle$  denotes expectation with respect to the zero-mean standard Gaussian function on  $R^m$  ( $m \geq n$ ). Here  $\tau$  denotes the time-evolution parameter of the diffusion (in a relativistic setting it should not be confused with the time variable), and for simplicity we shall assume always that  $\tau \geq 0$ . Consider the canonical Wiener space  $\Omega$  of continuous maps  $\omega : R \rightarrow R^n, \omega(0) = 0$ , with the canonical realization of the Wiener process  $W(\tau)(\omega) = \omega(\tau)$ . The (stochastic) flow of the s.d.e. (35) is a mapping

$$F_{\tau} : M \times \Omega \rightarrow M, \quad \tau \geq 0, \quad (36)$$

such that for each  $\omega \in \Omega$ , the mapping  $F(\cdot, \omega) : [0, \infty) \times M \rightarrow M$ , is continuous and such that  $\{F_{\tau}(x) : \tau \geq 0\}$  is a solution of equation (35) with  $F_0(x) = x$ , for any  $x \in M$ .

Let us assume in the following that the components  $X_{\beta}^{\alpha}, \hat{Q}^{\alpha}, \alpha, \beta = 1, \dots, n$  of the vectorfields  $X$  and  $\hat{Q}$  on  $M$  in (35) are predictable functions which further belong to  $C_b^{m, \epsilon}$  ( $0 \leq \epsilon \leq 1, m$  a non-negative integer), the space of Hoelder bounded continuous functions of degree  $m \geq 1$  and exponent  $\epsilon$ , and also that  $\hat{Q}^{\alpha}(\tau) \in L^1(R)$ , for any  $\alpha = 1, \dots, n$ . With these regularity conditions, if we further assume that  $\{x(\tau) : \tau \geq 0\}$  is a semimartingale on a probability space

$(\Omega, \mathcal{F}, P)$ , then it follows from Kunita [24] that equation (35) has a modification (which with abuse of notation we denote as)

$$F_\tau(\omega) : M \rightarrow M, \quad F_\tau(\omega)(x) = F_\tau(x, \omega), \quad (37)$$

which is a diffeomorphism of class  $C^m$ , almost surely for  $\tau \geq 0$  and  $\omega \in \Omega$ . We can obtain an identical result if we assume instead Sobolev regularity conditions. Indeed, assume that the components of  $\sigma$  and  $\hat{Q}$ ,  $\sigma_i^\beta \in H^{s+2}(T^*M)$  and  $\hat{Q}^\beta \in H^{s+1}(T^*M)$ ,  $1 \leq i \leq m$ ,  $1 \leq \beta \leq n$ , where the Sobolev space  $H^s(T^*M) = W^{2,s}(T^*M)$  with  $s > \frac{n}{2} + m$  (c.f. [55]). Then, the flow of equation (35) for fixed  $\omega$  defines a diffeomorphism in  $H^s(M, M)$  (see [55]), and hence by the Sobolev embedding theorem, a diffeomorphism in  $C^m(M, M)$  (i.e. a mapping from  $M$  to  $M$  which is  $m$ -times continuously differentiable as well as its inverse.) In any case, for  $1 \leq m$  we can consider the Jacobian (velocity, or "derived") flow of  $\{x_\tau : \tau \geq 0\}$ . It is a random diffusion process on  $TM$ , the tangent bundle of  $M$ .

**Remarks 2.** In the differential geometric approach due to V. Arnold [70] and Ebin-Marsden [9], for integrating NS on a smooth manifold as a perturbation (due to the diffusion term we shall present below) of the geodesic flow in the group of volume preserving diffeomorphisms of  $M$  (as the solution of the Euler equation), it was proved that under the above regularity conditions on the initial velocity, the solution flow of NS defines a diffeomorphism in  $M$  of class  $C^m$ . The difference of the Arnold-Ebin-Marsden classical differential geometry approach with the one presented here, is to integrate NS through a time-dependant **random** diffeomorphism <sup>2</sup> associated with a RCW connection.

Let us describe now the jacobian flow. We can describe it as the stochastic process on the tangent bundle,  $TM$ , given by  $\{v_\tau := T_{x_0}F_\tau(v_0) \in T_{F_\tau(x_0)}M, v_0 \in T_{x_0}M\}$ ; here  $T_zM$  denotes the tangent space to  $M$  at  $z$  and  $T_{x_0}F_\tau$  is the linear derivative of  $F_\tau$  at  $x_0$ . The process  $\{v_\tau, \tau \geq 0\}$  can be described (see [27]) as the solution of the invariant Ito s.d.e. on  $TM$ :

$$dv_\tau = \nabla^g \hat{Q}(\tau, v_\tau) d\tau + \nabla^g X(v_\tau) dW_\tau \quad (38)$$

<sup>2</sup>As we shall see, this result which follows straightforwardly from the most remarkable results due to Baxendale and Elworthy [55], makes apparent a stochastic extension of Einstein's Principle of General Covariance by which all the equations of Physics have to be invariant (covariant in the language of physicists) under transformations by classical diffeomorphisms. So underlying a gauge theory constructed in terms of RCW connections (say the equivalence between the non-linear massive Dirac-Hestenes invariant equation for a Dirac-Hestenes spinor operator field and the sourceless invariant Maxwell equations on a Lorentzian manifold [26,60], for which we stress that analytical continuation in the time variable of Lorentzian manifolds to yield Riemannian metrics is necessary), we have an associated active family of random diffeomorphisms.

<sup>3</sup>As wellknown, Hoelder continuity regularity conditions are basic in the usual functional analytical treatment of NS pioneered by Leray [45] (see also Temam [7]), and they are further related to the multifractal structure of turbulence [41]. Furthermore, this diffeomorphism property of random flows is fundamental for the construction of their ergodic theory [72,76,77].



If we take  $U$  to be an open neighborhood in  $R^n$  so that  $TU = U \times R^n$ , then  $v_\tau = (x_\tau, \tilde{v}_\tau)$  is described by the system given by integrating equation (35) and the invariant Ito s.d.e.

$$d\tilde{v}_\tau(x_\tau) = \nabla^g X(x_\tau)(\tilde{v}_\tau)dW_\tau + \nabla^g \hat{Q}(\tau, x_\tau)(\tilde{v}_\tau)d\tau, \quad (39)$$

with initial condition  $\tilde{v}_0 = v_0 \in T_{x(0)}$ . Thus,  $\{v_\tau = (x_\tau, \tilde{v}_\tau), \tau \geq 0\}$  defines a random flow on  $TM$ .

**Theorem 2 :** For any differential 1-form  $\phi$  of class  $C^{1,2}(R \times M)$  (i.e. in a local coordinate system  $\phi = a_\alpha(\tau, x)dx^\alpha$ , with  $a_\alpha(\tau, \cdot) \in C^2(M)$  and  $a_\alpha(\cdot, x) \in C^1(R)$ ) we have the Ito formula (Corollary 3E1 in [27]):

$$\begin{aligned} \phi(v_\tau) &= \phi(v_0) + \int_0^\tau \phi(\nabla^g X(v_s)dW_s + \int_0^\tau [\frac{\partial}{\partial s} + H_1(g, Q)]\phi(v_s)ds \\ &+ \int_0^\tau \nabla^g \phi(X(x)dW_s)(v_s) \\ &+ \int_0^\tau \text{trace } d\phi(X(x_s)-, \nabla^g X(v_s))(-)ds \end{aligned} \quad (40)$$

In the last term in (40) the trace is taken in the argument  $-$  of the bilinear form and further we have the mappings

$$\nabla^g Y : TM \rightarrow TM; \nabla^g \phi : TM \rightarrow T^*M.$$

**Remarks 3.** From (40) we conclude that the infinitesimal generators (i.g., for short in the following) of the derived stochastic process is not  $\partial_\tau + H_1(g, Q)$ , due to the last term in (40). This term vanishes identically in the case we shall present in the following section, that of gradient diffusions. An alternative method which bypasses the velocity process although is related to it, is the construction of the generalized Hessian flow further below. Both methods will provide for the setting for the implicit integration of NS and the kinematic dynamo.

## 5 Riemann-Cartan-Weyl Gradient Diffusions

Suppose that there is an isometric embedding of an  $n$ -dimensional compact orientable manifold  $M$  into a Euclidean space  $R^m: f : M \rightarrow R^m, f(x) = (f^1(x), \dots, f^m(x))$ . Suppose further that  $X(x) : R^m \rightarrow T_x M$ , is the orthogonal projection of  $R^m$  onto  $T_x M$  the tangent space at  $x$  to  $M$ , considered as a subset of  $R^m$ . Then, if  $e_1, \dots, e_m$  denotes the standard basis of  $R^m$ , we have

$$X = X^i e_i, \text{ with } X^i = \text{grad } f^i, i = 1, \dots, m. \quad (41)$$

The second fundamental form [25] is a bilinear symmetric map

$$\alpha_x : T_x M \times T_x M \rightarrow \nu_x M, x \in M, \quad (42)$$

with  $\nu_x M = (T_x M)^\perp$  the space of normal vectors at  $x$  to  $M$ . We then have the associated mapping

$$A_x : T_x M \times \nu_x M \rightarrow T_x M, \langle A_x(u, \zeta), v \rangle_{R^m} = \langle \alpha_x(u, v), \zeta \rangle_{R^m}, \quad (43)$$

for all  $\zeta \in \nu_x M$ ,  $u, v \in T_x M$ . Let  $Y(x)$  be the orthogonal projection onto  $\nu_x M$

$$Y(x) = e - X(x)(e), x \in M, e \in R^m. \quad (44)$$

Then:

$$\nabla^g X(v)(e) = A_x(v, Y(x)e), v \in T_x M, x \in M. \quad (45)$$

For any  $x \in M$ , if we take  $e_1, \dots, e_m$  to be an orthonormal base for  $R^m$  such that  $e_1, \dots, e_m \in T_x M$ , then for any  $v \in T_x M$ , we have

$$\text{either } \nabla^g X(v)e_i = 0, \text{ or } X(x)e_i = 0. \quad (46)$$

We shall consider next the RCW gradient diffusion processes, i.e. for which in equation (35) we have specialized taking  $X = \text{grad}f$ . Let  $\{v_\tau : \tau \geq 0\}$  be the associated derived velocity process. We shall now give the Ito-Elworthy formula for 1-forms.

**Theorem 3.** Let  $f : M \rightarrow R^m$  be an isometric embedding. For any differential form  $\phi$  of degree 1 in  $C^{1,2}(R \times M)$ , the Ito formula is

$$\begin{aligned} \phi(v_\tau) &= \phi(v_0) + \int_0^\tau \nabla^g \phi(X(x_s) dW_s) v_s + \int_0^\tau \phi(A_x(v_s, Y(x_s) dW_s) \\ &+ \int_0^\tau \left[ \frac{\partial}{\partial s} + H_1(g, Q) \right] \phi(v_s) ds, \end{aligned} \quad (47)$$

i.e.  $\partial_\tau + H_1(g, Q)$ , is the i.g. (with domain the differential 1-forms belonging to  $C^{1,2}(R \times M)$ ) of  $\{v_\tau : \tau \geq 0\}$ .

Proof: It follows immediately from the facts that the last term in the r.h.s. of (40) vanishes due to (46), while the second term in the r.h.s. of (40) coincides with the third term in (47) due to (45).

Consider the value  $\Phi_x$  of a  $k$ -form at  $x \in M$  as a linear map:  $\Phi_x : \Lambda^k T_x M \rightarrow R$ . In general, if  $E$  is a vector space and  $A : E \rightarrow E$  is a linear map, we have the induced maps

$$\Lambda^k A : \Lambda^k E \rightarrow \Lambda^k E, \quad \Lambda^k(v^1 \wedge \dots \wedge v^k) := Av^1 \wedge \dots \wedge Av^k;$$

and

$$(d\Lambda^k)A : \Lambda^k E \rightarrow \Lambda^k E,$$

$$(d\Lambda^k)A(v^1 \wedge \dots \wedge v^k) := \sum_{j=1}^k v^1 \wedge \dots \wedge v^{j-1} \wedge Av^j \wedge v^{j+1} \wedge \dots \wedge v^k.$$

For  $k = 1, (d\Lambda)A = \Lambda A$ . The Ito formula for  $k$ -forms,  $1 \leq k \leq n$ , is due to Elworthy (Prop. 4B [27]).

**Theorem 4.** Let  $M$  be isometrically embedded in  $R^m$ . Let  $V_0 \in \Lambda^k T_{x_0} M$ . Set  $V_\tau = \Lambda^k(TF_\tau)(V_0)$  Then for any differential form  $\phi$  of degree  $k$  in  $C^{1,2}(R \times M)$ ,  $1 \leq k \leq n$ ,

$$\begin{aligned} \phi(V_\tau) &= \phi(V_0) + \int_0^\tau \nabla^g \phi(X(x_s) dW_s)(V_s) \\ &+ \int_0^\tau \phi((d\Lambda)^k A_{x_s}(-, Y(x_s) dW_s)(V_s)) \\ &+ \int_0^\tau \left[ \frac{\partial}{\partial s} + H_k(g, \hat{Q}) \right] \phi(V_s) ds \end{aligned} \quad (48)$$

i.e.,  $\partial_\tau + H_k(g, \hat{Q})$  is the i.g. (with domain of definition the differential forms of degree  $k$  in  $C^{1,2}(R \times M)$ ) of  $\{V_\tau : \tau \geq 0\}$ .

**Remarks 4.** Therefore, starting from the flow  $\{F_\tau : \tau \geq 0\}$  of the s.d.e. (35) with i.g. given by  $\partial_\tau + H_0(g, Q)$ , we obtained that the derived velocity process  $\{v(\tau) : \tau \geq 0\}$  given by (38) (or (35) and (39)) has  $H_1(g, Q)$  as i.g.; finally, if we consider the diffusion of differential forms of degree  $k \geq 1$ , we get that  $\partial_\tau + H_k(g, Q)$  is the i.g. of the process  $\Lambda^k v(\tau)$ , i.e. the exterior product of degree  $k$  ( $k = 1, \dots, n$ ) of the velocity process. In particular,  $\partial_\tau + H_2(g, Q)$  is the i.g. of the stochastic process  $\{v(\tau) \wedge v(\tau) : \tau \geq 0\}$ .

Note that consistently with the notation we have that  $\{\Lambda^0 v_\tau : \tau \geq 0\}$  is the position process  $\{x_\tau : \tau \geq 0\}$  untop of which  $\{\Lambda^k v_\tau : \tau \geq 0\}$ , ( $1 \leq k \leq n$ ) is fibered (recall,  $\Lambda^0(M) = M$ ). We can resume our results in the following theorem.

**Theorem 5.** Assume  $M$  is isometrically embedded in  $R^m$ . There is a one to one correspondance between RCW connections  $\nabla$  determined by a Riemannian metric  $g$  and trace-torsion  $Q$  with the family of gradient diffusion processes  $\{\Lambda^k v_\tau : \tau \geq 0\}$  generated by  $H_k(g, Q)$ ,  $k = 0, \dots, n$

Finally, for isometrically embedded manifolds,  $f : M \rightarrow R^m$ , we are now in a situation for presenting the solution of the Cauchy problem

$$\frac{\partial \phi}{\partial \tau} = H_k(g, Q_\tau)(x) \phi, \tau \in [0, T] \quad (49)$$

with the given initial condition

$$\phi(0, x) = \phi_0(x), \quad (50)$$

for  $\phi$  and  $\phi_0$   $k$ -forms on a smooth compact orientable manifold isometrically embedded in  $R^m$ ,  $\phi$  being time-dependant. From the Ito-Elworthy formula follows that the formal solution of this problem is as follows. Consider the diffusion process on  $M$  generated by  $H_0(g, Q)$ : For each  $\tau \in [0, T]$  consider the s.d.e. (with  $s \in [0, \tau]$ ):

$$dx_s^{\tau, x} = X(x_s^{\tau, x}) dW_s + \hat{Q}(\tau - s, x_s^{\tau, x}) ds, \text{ where } X = \text{grad } f, \quad (51)$$

with initial condition

$$x_0^{\tau,x} = x, \tag{52}$$

and the derived velocity process

$$\{v_s^{\tau,v(x)} = (x_s^{\tau,x}, \tilde{v}_s^{\tau,v(x)}), 0 \leq s \leq \tau\}, \tag{53}$$

satisfying further

$$d\tilde{v}_s^{\tau,v(x)} = \nabla^g X(x_s^{\tau,x})(\tilde{v}_s^{\tau,v(x)})dW_s + \nabla^g \hat{Q}(\tau - s, x_s^{\tau,x})(\tilde{v}_s^{\tau,v(x)})ds, \tag{54}$$

with initial condition

$$\tilde{v}_0^{\tau,v(x)} = v(x). \tag{55}$$

Then, the  $C^{1,2}$  (formal) solution of the Cauchy problem defined in  $[0, T] \times M$  is

$$\phi(\tau, x)(\Lambda^k v(x)) = E_x[\phi_0(x_\tau^{\tau,x})(\Lambda^k \tilde{v}_\tau^{\tau,v(x)})], \tag{56}$$

where  $\Lambda^k v(x)$  is a shorthand notation for the exterior product of  $k$  linearly independent vectors on  $T_x M$  and in the r.h.s. of (56),  $\Lambda^k \tilde{v}_\tau^{\tau,v(x)}$  denotes the exterior product of the  $k$  flows having them as initial conditions.

## 6 The Navier-Stokes Equations and Riemann-Cartan-Weyl Diffusions

In the sequel,  $M$  is a compact orientable ( *without boundary*)  $n$ -manifold with a Riemannian metric  $g$ . We provide  $M$  with a 1-form  $u(\tau, x) = u_\tau(x)$  such that  $\delta u_\tau = 0$  and satisfying the invariant Navier-Stokes equations (NS) [9,53,74],

$$\frac{\partial u}{\partial \tau} + P[\nabla_{\dot{u}_\tau}^g u_\tau] - \nu \Delta_1 u_\tau = 0, \tag{57}$$

where  $P$  is the projection operator to the co-closed term in the de Rham-Kodaira-Hodge decomposition of 1-forms. We have proved in [66], that we can rewrite NS in the form of a non-linear diffusion equation<sup>4</sup>

$$\frac{\partial u}{\partial \tau} = PH_1(2\nu g, \frac{-1}{2\nu} u_\tau)u_\tau, \tag{58}$$

---

<sup>4</sup>For a detailed proof see the accompanying article by the author in the representations for NS in the smooth boundary case. While in the boundaryless case  $P$  commutes with  $\Delta_1$ , in the case of  $M$  with smooth boundary this is no longer true so that we have to take  $P\Delta_1 u_\tau$  instead of the viscosity term in (57) (c.f. page 144, [9]), and we are left with the non-linear diffusion equation (58) in any case.

which means that NS for the velocity of an incompressible fluid is a non-linear diffusion process determined by a RCW connection. This connection has  $2\nu g$  for the metric, and the time-dependant trace-torsion of this connection is  $-u/2\nu$ . Then, the drift of this process does not depend explicitly on  $\nu$ , as it coincides with the vectorfield associated via  $g$  to  $-u_\tau$ , i.e.  $-\hat{u}_\tau$ . Let us introduce the vorticity two-form

$$\Omega_\tau = du_\tau, \tau \geq 0. \quad (59)$$

Now, if we know  $\Omega_\tau$  for any  $\tau \geq 0$ , we can obtain  $u_\tau$  by inverting the definition (59). Namely, applying  $\delta$  to (59) and taking in account (23) and (28), we obtain the Poisson-de Rham equation

$$H_1(g, 0)u_\tau = -\delta\Omega_\tau, \tau \geq 0. \quad (60)$$

Thus, the vorticity  $\Omega_\tau$  is a source for the velocity one-form  $u_\tau$ , for all  $\tau$ ; in the case that  $M$  is a compact euclidean domain, equation (60) is integrated to give the Biot-Savart law of Fluid Mechanics [1,39]. Now, apply  $d$  to (58); we obtain the evolution equation (c.f. [66]):

$$\frac{\partial\Omega_\tau}{\partial\tau} = H_2(2\nu g, \frac{-1}{2\nu}u_\tau)\Omega_\tau. \quad (61)$$

**Theorem 6.** Given a compact orientable Riemannian manifold with metric  $g$ , the Navier-Stokes equation (57) for an incompressible fluid with velocity one-form  $u = u(\tau, x)$  such that  $\delta u_\tau = 0$ , assuming sufficiently regular conditions, are equivalent to a diffusion equation for the vorticity given by (61) with  $u_\tau$  satisfying the Poisson-de Rham equation (60). The RCW connection on  $M$  generating this process is determined by the metric  $2\nu g$  and a trace-torsion 1-form given by  $-u/2\nu$ .

**Observations** This characterization of NS in terms of a gauge structure, will determine all the random representations for NS which we shall present in this article. <sup>5</sup> We would like to recall that in the gauge theory of gravitation [46,57] the torsion is related to the translational degrees of freedom present in the Poincaré group, i.e. to the gauging of momentum. Here we find a similar, yet dynamical situation, in which the trace-torsion is related to the velocity.

## 7 Random Diffeomorphisms and the Navier-Stokes Equations

As an immediate corollary of Theorem 6, we have (on assuming that  $M$  is boundaryless) the following fundamental result

---

<sup>5</sup>As explained in detail in [66], C. Peskin has actually derived NS on  $R^3$  from an ad-hoc s.d.e., which actually does not depend in its noise term, which is taken as defined on the two-sphere, for reasons of isotropicity [68].

**Theorem 7.** The lagrangian random flow associated to NS is given by integrating the Ito s.d.e.

$$dx^{\nu,\tau,x} = [2\nu]^{\frac{1}{2}} X(x^{\nu,\tau,x})dW(\tau) - \hat{u}(\tau, x^{\nu,\tau,x})d\tau, x^{\nu,0,x} = x, \tau \in [0, T], \quad (62)$$

where we have assumed that the diffusion tensor  $X$  and the drift  $-\hat{u}_\tau$  (the  $g$ -conjugate to  $u_\tau$ ) have the regularity conditions stated above, so that the random flow of equation (62) is a diffeomorphism of  $M$  of class  $C^m$ ,  $m \geq 1$ .

**Remarks 5.** This is obvious from our Theorem 6 and previous constructions, since the projection on  $M$  of the flow with i.e. given by  $H_2(2\nu g, -\frac{1}{2\nu}u_\tau$  ( $\tau \geq 0$ ) has for i.g. the operator  $H_0(2\nu g, -\frac{1}{2\nu}u_\tau)$ , and thus coincides with equation (62). Note that the effect of curvature is already incorporated in this flow, which is in fact a diffusion of *scalars*; in our formalism, it is clear that at an operator level, the effect of the (Riemannian) Ricci curvature of  $M$  is dealt by lifting the diffusion of scalars to that of differential forms of degree higher than 1, and *not* by incorporating it at the level of scalar diffusions.

## 8 Cauchy Problem for the Vorticity in the Case of Isometric Immersion of $M$

In the following we assume additional conditions on  $M$ , namely that  $f : M \rightarrow R^m$  is an isometric embedding <sup>6</sup>

Let us solve the Cauchy problem for  $\Omega(\tau, x)$  of class  $C^m$  in  $[0, T] \times M$  satisfying (61) with initial condition  $\Omega_0(x)$ . For each  $\tau \in [0, T]$  consider the s.d.e. (with  $s \in [0, \tau]$ ) (obtained by time-reversing Lagrangian representation (62) above):

$$dx_s^{\nu,\tau,x} = (2\nu)^{\frac{1}{2}} X(x_s^{\nu,\tau,x})dW_s - \hat{u}(\tau - s, x_s^{\nu,\tau,x})ds, \quad (63)$$

where

$$X = \nabla f, \quad (64)$$

is the diffusion tensor, and further, with initial condition

$$x_0^{\nu,\tau,x} = x, \quad (65)$$

and the derived velocity process  $\{v_s^{\nu,\tau,v(x)} = (x_s^{\nu,\tau,x}, \tilde{v}_s^{\nu,\tau,v(x)}), 0 \leq s \leq \tau\}$ :

$$d\tilde{v}_s^{\nu,\tau,v(x)} = (2\nu)^{\frac{1}{2}} \nabla^g X(x_s^{\nu,\tau,x})(\tilde{v}_s^{\nu,\tau,v(x)})dW_s - \nabla^g \hat{u}(\tau - s, x_s^{\nu,\tau,x})(\tilde{v}_s^{\nu,\tau,v(x)})ds, \quad (66)$$

with initial condition

$$\tilde{v}_0^{\nu,\tau,v(x)} = v(x). \quad (67)$$

---

<sup>6</sup>Although this section has been elaborated in [66], we have chosen to present briefly its main results to allow for an immediate discussion of other results to appear below.

Let  $\Omega_\tau(x)$  be a bounded  $C^{1,2}$  solution of the Cauchy problem; then it follows from the Ito formula-Elworthy (48) (with  $k = 2$ ) that it is given by the expression

$$\tilde{\Omega}_\tau(\Lambda^2 v(x)) = E_x[\Omega_0(x_{\tau'}^{\nu, \tau, x})(\Lambda^2 \tilde{v}_{\tau'}^{\nu, \tau, v(x)})] \quad (68)$$

where the expectation value at  $x$  is taken with respect to the measure on the process  $\{x_\tau^{\nu, \tau, x} : \tau \in [0, T]\}$  (whenever it exists):

**Remarks 6.** Thus, to compute the vorticity at time  $\tau$  on a bivector  $\Lambda^2 v(x) \in \Lambda^2 T^*M$  ( $x \in M$ ), we contract the time-zero vorticity with the runned back derived process starting at  $v(x)$  and further take expectation values for all runned backwards paths that at time  $\tau$  start at  $x$ . Note that in these representations, both for dimensions 2 and 3, we have a coupling of the deformation tensor (and furthermore of the Riemannian covariant derivative of the noise term) to the original vorticity along the runned backwards paths of fluid's particles; both these terms contribute to the complicated topology of turbulent flows. Furthermore, these representations account for the Riemannian curvature of  $M$  in spite that the curvature does not appear explicitly in them. When considering flat Euclidean space,  $R^2$ , where there is no longer curvature and the vorticity equation becomes an equation for a (pseudo) scalar field, this deformation due to noise and stress of the time-zero vorticity does no longer appear; it is simply a transport of the time-zero vorticity along the lagrangian random flow (see section 11 below).

## 8.1 Integration of the Poisson-de Rham equation

In (62) we have that  $u_\tau$  verifies (60), for every  $\tau \geq 0$ , Consider the autonomous s.d.e. generated by  $H_0(g, 0) = \frac{1}{2}\Delta_g$ :

$$dx_s^{g,x} = X(x_s^g)dW_s, x_0^{g,x} = x. \quad (69)$$

We shall solve the Dirichlet problem for equation (60) in an open set  $U$  (of a partition of unity) of  $M$  with the boundary condition  $u_\tau \equiv \phi$  on  $\partial U$ , with  $\phi$  a given 1-form. Then one can "glue" the solutions and use the strong Markov property to obtain a global solution (cf. [31]). Consider the derived velocity process  $v^g(s) = (x^g(s), \tilde{v}^g(s))$  on  $TM$ , with  $\tilde{v}^g(s) \in T_{x^g(s)}M$ , whose i.g. is  $H_1(g, 0)$ , i.e. from (35) we have:

$$d\tilde{v}_s^{g,v(x)}(x_s^{g,x}) = \nabla^g X(x_s^{g,x}(s))(\tilde{v}^{g,v(x)}(s))dW(s), \quad (70)$$

with initial velocity  $\tilde{v}^{g,v(x)}(0) = v(x)$ . Notice that equations (69&70) are obtained by taking  $u \equiv 0$  in equation (62) and its derived process, respectively, and further rescaling by  $(2\nu)^{-\frac{1}{2}}$ . Then if  $u_\tau$  is a solution of equation (60) for any fixed  $\tau \in [0, T]$ , applying to it the Ito-Elworthy formula and assuming further that  $\delta\Omega_\tau$  is bounded, we then obtain that the formal  $C^{1,2}$  solution of the Dirichlet problem is given by (see [66]):

$$\tilde{u}_\tau(x)(v(x)) = E_x^B[\phi(x_{\tau_e}^{g,x})(v_{\tau_e}^{g,v(x)}) + \int_0^{\tau_e} \frac{1}{2}\delta\Omega_\tau(x_s^{g,x})(v_s^{g,v(x)})ds]$$

$$= \int [\phi(x_{\tau_e}^{g,x})(v_{\tau_e}^{g,v(x)}) + 1/2 \int_0^{\tau_e} \delta\Omega_\tau(y)(v_s^{g,v(x)}(y))ds]p^g(s,x,y)vol_g(y), \quad (71)$$

where  $\tau_e = \inf\{s : x_s^{g,x} \notin U\}$ , the first-exit time of  $U$  of the process  $\{x_s^{g,x}\}$ , and  $E^B$  denotes the expectation value with respect to  $p^g(s,x,y)$ , the transition density of the s.d.e. (69), i.e.the fundamental solution of the heat equation on  $M$ :

$$\partial_\tau p(y) = H_0(g,0)(y)p(y) \equiv 1/2\Delta_g p(y) \quad (72)$$

with  $p(s,x,-) = \delta_x$  as  $s \downarrow 0$ .

**Theorem 9.** Assume that  $g$  is uniformly elliptic,  $U$  has a  $C^{2,\epsilon}$ -boundary,  $g^{\alpha\beta}$  and  $\delta\Omega_\tau$  are Hoelder-continuous of order  $\epsilon$  on  $U$  and  $u_\tau$  is uniformly Hoelder-continuous of order  $\epsilon$ , for  $\tau \in [0, T]$ . Then the solution of the Dirichlet problem above has a unique solution belonging to  $C^{2,\epsilon}(U)$  for each  $\tau \in [0, T]$ . Assume instead that  $u_\tau \in H^1(T^*U)$  for each  $\tau \in [0, T]$ , i.e. belongs to the Sobolev space of order 1. If  $\delta\Omega_\tau \in H^{k-1}(\Lambda^1(T^*U))$ , then  $u_\tau \in H^{k+1}(\Lambda^1(T^*U))$ , for  $k \geq 1$  and  $\tau \in [0, T]$ .

**Proof.** It follows from an extension of the maximum principle [31,47] to differential forms (cf. Prop. 1.5 and comments in page 307 in [53]).

We remark as we did in Remarks 6, that these representations (68 – 71) have a built-in treatment of the Riemannian curvature. This dependance might be exhibited through the scalar curvature term in the Onsager-Machlup lagrangian (see [35,44]) appearing in the path-integral representation of the fundamental solution of the transition densities of the representations for the vorticity and for the velocity. There is further a dependance of the solution on the global geometry and topology of  $M$  appearing through the Riemannian spectral invariants of  $M$  in the short-time asymptotics of these transition densities [28,29,43,82].

## 9 Kinematic Dynamo Problem of Magnetohydrodynamics

The kinematic dynamo equation for a passive magnetic field transported by an incompressible fluid, is the system of equations (c.f.[56]) for the time-dependant magnetic vectorfield  $B(\tau,x) = B_\tau(x)$  on  $M$  defined by  $i_{B_\tau}\mu(x) = \omega_\tau(x)$  (for  $\tau \geq 0$ ), satisfying

$$\partial_\tau \omega + (L_{\hat{u}_\tau} - \nu^m \Delta_{n-1})\omega_t = 0, \omega(0,x) = \omega(x), 0 \leq t, \quad (73)$$

where  $\nu^m$  is the magnetic diffusivity, and we recall that  $\mu = vol(g) = det(g)^{\frac{1}{2}} dx^1 \wedge \dots \wedge dx^n$  is the Riemannian volume density ( $(x^1, \dots, x^n)$  a local coordinate system on  $M$ ), and  $\omega \in \Lambda^{n-1}(R \times T^*M)$ . In equation (73)  $u$  is assumed given, and it may either be a solution of NS, or of the Euler equation given by setting



$\nu = 0$  in (57). From the definition follows that  $\text{div} B_\tau \equiv 0$ , for any  $\tau \geq 0$ . Now we note that from (28) we can rewrite this problem as

$$\partial_\tau \omega = H_{n-1}(2\nu^m g, -\frac{1}{2\nu^m} u_\tau) \omega_\tau, \omega(0, x) = \omega(x), 0 \leq \tau, \quad (74)$$

as a linear evolution equation for a  $(n - 1)$ -form, similar to the evolution Navier-Stokes equation for the vorticity. Now if we assume that there is an isometric embedding  $f : M \rightarrow R^m$ , so that the diffusion tensor  $X = \nabla f$ , we can take the Lagrangian representation for the scalar diffusion generated by  $H_0(2\nu^m g, -\frac{1}{2\nu^m} u_\tau)$ , i.e. the Ito s.d.e. given by substituting  $\nu^m$  instead of  $\nu$  in the random lagrangian equations (63) and its derived process (65), then the formal  $C^{1,2}$  solution of (73) defined on  $[0, T] \times M$  for some  $T > 0$ , is given by

$$\tilde{\omega}_\tau(\Lambda^{n-1} v(x)) = E_x[\omega_0(x_\tau^{\nu^m, \tau, x})(\Lambda^{n-1} \tilde{v}_\tau^{\nu^m, \tau, v(x)})] \quad (75)$$

**Remarks 6.** We note that similarly to the representation for the vorticity, instead of the initial vorticity now it is the initial magnetic field which is transported backwards along the scalar magnetic diffusion, and along its way it is deformed by the fluid's deformation tensor and the gradient of the diffusion tensor noise term (this accurately represents the actual macroscopical physical phenomena), and finally we take the average for all those paths starting at  $x$ . For both the vorticity and the kinematic dynamo equations as well as the Poisson-de Rham equation, we have a mesoscopic description which clearly evokes the Feynman approach to Quantum Mechanics through a summation of the classical action of the mechanical system along non-differentiable paths. In distinction with the usual Feynman approach, these Brownian integrals are well defined and they additionally have a clear physical interpretation which coincides with actual experience.

## 10 Random Implicit Integration Of The Navier-Stokes Equations For Compact Manifolds

Up to this point, all our constructions have stemmed from the fact that for gradient diffusion processes, the Ito-Elworthy formula shows that the random process on  $\Lambda^2 TM$  given by  $\{\Lambda^2 v_\tau : \tau \geq 0\}$  with  $\{v_\tau : \tau \geq 0\}$  the jacobian process fibered on the diffusion process  $\{\Lambda^0 v_\tau \equiv x_\tau : \tau \geq 0\}$  on  $M$  given by equation (62), is a random Lagrangian flow for the Navier-Stokes equation. Our previous constructions have depended on the form of the isometric embedding of  $M$ . This construction is very general; indeed from a well known theorem due to J. Nash (1951) further elaborated by de Georgi and Moser, such an embedding exists of class  $C^\infty$  for any smooth manifold (cf. [53]). (Furthermore, our assumption of compactness is for the obtention of a random flow which is defined for all times, and gives a global diffeomorphism of  $M$ . The removal of

this condition, requires to consider the random flow up to its explosion time, so that in this case we have a local diffeomorphism of  $M$ .)

There is an alternative construction of diffusions of differential forms which does not depend on the embedding of  $M$  in Euclidean space, being thus the objective of the following section its presentation. A fortiori, we shall apply these constructions to integrate NS and the kinematic dynamo problem.

### 10.1 The Generalized Hessian Flow

In the following  $M$  is a complete compact orientable smooth manifold without boundary. We shall construct another flow in distinction of the derived flow of the previous sections, which depends explicitly of the curvature of the manifold, and also of the drift of the diffusion of scalars. We start by considering an autonomous drift vector field  $\hat{Q}$  (further below we shall lift this condition) and we define a flow  $W_\tau^{k,\hat{Q}}$  on  $\Lambda^k T M$  ( $1 \leq k \leq n$ ) over the flow of equation (35),  $\{F_\tau(x_0) : \tau \geq 0\}$ , by the invariant equation with initial condition  $V_0 \in \Lambda^k T M$ :

$$\frac{D^g W_\tau^{k,\hat{Q}}}{\partial \tau}(V_0) = -1/2 R^k(W_\tau^{k,\hat{Q}}(V_0)) + (d\Lambda^k)(\nabla^g \hat{Q}(\cdot))(W_\tau^{k,\hat{Q}}(V_0)), \quad (76)$$

where  $\frac{D^g}{\partial \tau}$  denotes the Riemannian covariant derivative along the paths defined by equation (35). These processes are the generalized Hessian processes.

**Proposition 1 (Elworthy [27]).** Assume that  $\frac{1}{2}R^k - (d\Lambda^k)(\nabla^g \hat{Q})(\cdot)$  is bounded below. Define  $P_\tau^k : L^\infty \Lambda^k T^* M \rightarrow L^\infty \Lambda^k T^* M$  by

$$P_\tau^k(\phi)(V) = E(\phi(W_\tau^{k,\hat{Q}}(V))) \quad (77)$$

for  $V \in \Lambda^k T_x M$ ,  $\phi \in L^\infty \Lambda^k T^* M$ . Then  $\{P_\tau^k : \tau \geq 0\}$  is a contraction semigroup of bounded continuous forms and is strongly continuous there with i.g. agreeing with  $H_k(g, Q)$  on  $C^2(M)$ .

Under the above conditions we can integrate the heat equation for bounded twice differentiable  $k$ -forms of class  $C^2$  ( $0 \leq k \leq n$ ) and in the general case of a non-autonomous drift vector field  $\hat{Q} = \hat{Q}_\tau(x)$ . Indeed, for every  $\tau \geq 0$  consider the flow  $V_s^\tau = W_{\tau,s}^{k,\hat{Q}}$  over the flow of  $\{x_s^\tau : 0 \leq s \leq \tau\}$ , given by the equation

$$dx_s^{x,\tau} = X(x_s^{x,\tau})dW_s + \hat{Q}_{\tau-s}(x_s^{x,\tau})ds, x_0^{x,\tau} = x,$$

obtained by integration of the equation

$$\frac{D^g V_s^\tau}{\partial s}(v_0) = -1/2 R^k(V_s^\tau(v_0)) + (d\Lambda^k)(\nabla^g \hat{Q}_{\tau-s}(\cdot))(V_s^\tau(v_0)), \quad (78)$$

with  $v_0 = V_0^\tau \equiv v(x) \in \Lambda^k T_x M$ . Then, applying the Ito-Elworthy formula we prove as before that if  $\tilde{\alpha}_\tau$  is a bounded  $C^{1,2}$  solution of the Cauchy problem for the heat equation for  $k$  forms:

$$\frac{\partial}{\partial \tau} \alpha_\tau = H_k(g, Q_\tau) \alpha_\tau \quad (79)$$

with initial condition  $\alpha_0(x) = \alpha(x)$  a given  $k$ -form of class  $C^2$ , then the solution of the heat equation is

$$\alpha_\tau(v(x)) = E_x[\alpha_0(V_\tau^\tau(v(x)))], \quad (80)$$

with  $V_\tau^\tau(x)$  the generalized Hessian flow over the flow  $\{F_\tau(x) : \tau \geq 0\}$  of  $\{x_\tau^\tau : \tau \geq 0\}$  with the initial condition  $v(x) \in \Lambda^k T_x M$ .

To integrate the Poisson-de Rham equation we shall need to consider the so-called Ricci-flow  $W_\tau^\mathcal{R} \equiv W_\tau^{1,0}(\omega) : TM \rightarrow TM$  over the random flow generated by  $H_0(g, 0)$ , obtained by integrating the covariant equation (so we fix the drift to zero and further take  $k = 1$  in (78))

$$\frac{D^g W_\tau^\mathcal{R}}{\partial \tau}(v_0) = -\frac{1}{2} \tilde{Ric}(W_\tau^\mathcal{R}(v_0), -), v_0 \in T_{x_0} M \quad (81)$$

where  $Ric : TM \oplus TM \rightarrow R$  is the Ricci curvature and  $\tilde{Ric}(v, -) \in T_x M$  is the conjugate vector field defined by  $\langle \tilde{Ric}(v, -), w \rangle = Ric(v, w)$ ,  $w \in T_x M$ .

## 10.2 Integration of the Cauchy problem for the Vorticity on Compact Manifolds

**Theorem 10:** The integration of the equation (61) with initial condition  $\Omega(0, \cdot) = \Omega_0$  yields

$$\Omega_\tau(v(x)) = E_x[\Omega_0(V_\tau^\tau(v(x)))] \quad (82)$$

where  $\{V_\tau^\tau : \tau \geq 0\}$  is the solution flow over the flow of  $\{x_\tau^{\nu, \tau, x} : \tau \geq 0\}$  (see equation (63)) of the covariant equation

$$\begin{aligned} \frac{D^g W_{\tau, s}^{2, -\hat{u}_0}}{\partial s}(v(x)) &= -\nu R^2(W_{\tau, s}^{k, -\hat{u}_0}(v(x))) \\ &- (d\Lambda^2)(\nabla^g \hat{u}_0(\cdot))(W_{\tau, s}^{2, -\hat{u}_0}(v(x))), s \in [0, \tau] \end{aligned} \quad (83)$$

with the initial condition  $v(x) \in \Lambda^2 T_x M$  [58]. In this expression,  $\nabla^g \hat{u}_0(\cdot)$  is a linear transformation,  $A$ , between  $T_x^* M$  and  $T_x M$ , and

$$d\Lambda^2(A) : T_x M \wedge T_x M \rightarrow T_x M \wedge T_x M$$

is given by

$$d\Lambda^2(A)(v_1 \wedge v_2) = Av_1 \wedge v_2 + v_1 \wedge Av_2, \quad (84)$$

for any  $v_1, v_2 \in T_x M$ ,  $x \in M$ .

### 10.3 Integration of the Kinematic Dynamo for Compact Manifolds

Substituting the magnetic diffusivity  $\nu^m$  instead of the kinematic viscosity in (63) and we further consider  $\{V_s^\tau : s \in [0, \tau]\}$  given by the solution flow over the flow of  $\{x_s^{\nu^m, \tau, x} : s \in [0, \tau]\}$  of the invariant equation

$$\frac{D^g V_s^\tau}{\partial s}(v(x)) = -\nu^m R^{n-1}(V_s^\tau(v(x))) - (d\Lambda^{n-1})(\nabla^g \hat{u}_{\tau-s}(\cdot))(V_s^\tau(v(x))), \quad (85)$$

with  $v(x) = V_0^\tau \in \Lambda^{n-1}T_x M$ . Then, the formal  $C^{1,2}$  solution of (73) is

$$\omega_\tau(v(x)) = E_x[\omega_0(V_\tau^\tau(v(x)))]. \quad (86)$$

with  $E_x$  denoting the expectation valued with respect to the measure on  $\{x_\tau^{\nu^m, \tau, x}\}$  (whenever it exists).

### 10.4 Integration of the Poisson-de Rham Equation for the Velocity

With the same notations as in the case of isometrically embedded manifolds, we have a martingale problem with a bounded solution given by

$$u_\tau(v(x)) = E_x^B[\phi(W_{\tau_e}^{\mathcal{R}}(v(x))) + 1/2 \int_0^{\tau_e} \delta\Omega_\tau(W_s^{\mathcal{R}}(v(x)))ds], \quad (87)$$

where  $v(x) \in T_x M$  is the initial condition for  $W_\tau^{\mathcal{R}}$ .

## 11 Solutions of NS on euclidean space

In the case that  $M$  is euclidean space, the solution of NS is easily obtained from the solution in the general case [58,66]. In this case the isometric embedding  $f$  of  $M$  is realized by the identity mapping, i.e.  $f(x) = x, \forall x \in M$ . Hence the diffusion tensor  $X = I$ , so that the metric  $g$  is also the identity. For this case we shall assume that the velocity vanishes at infinity, i.e.  $u_t \rightarrow 0$  as  $|x| \rightarrow \infty$ . (This allows us to carry out the application of the general solution, in spite of the non-compactness of space). Furthermore,  $\tau_e = \infty$ . The solution for the vorticity equation results as follows. We have the s.d.e. (see equation (63) where we omit the superscript for the kinematical viscosity, for simplicity)

$$dx_s^{\tau, x} = -u(\tau - s, x_s^{\tau, x})ds + (2\nu)^{\frac{1}{2}}dW_s, x_0^{\tau, x} = x, s \in [0, \tau]. \quad (88)$$

The derived process is given by the solution of the o.d.e. (since in equation (66) we have  $\nabla X \equiv 0$ )

$$d\tilde{v}_s^{\tau, x, v(x)} = -\nabla u(\tau - s, x_s^{\tau, x})(\tilde{v}_s^{\tau, x, v(x)})ds, v_0^{\tau, v(x)} = v(x) \in R^n, s \in [0, \tau], \quad (89)$$

Now for  $n = 3$  we have that the vorticity  $\Omega(\tau, x)$  is a 2-form on  $R^3$ , or still by duality has an adjoint 1-form, or still a  $R^3$ -valued function, which with abuse of notation we still write as  $\tilde{\Omega}(\tau, \cdot) : R^3 \rightarrow R^3$ , which from (68) we can write as

$$\tilde{\Omega}(\tau, x) = E_x[\tilde{v}_\tau^{\tau, x, I} \Omega_0(x_\tau^{\tau, x})], \quad (90)$$

where  $E_x$  denotes the expectation value with respect to the measure (if it exists) on  $\{x_\tau^{\tau, x} : \tau \geq 0\}$ , for all  $x \in R^3$ , and in the r.h.s. of expression (90) we have matrix multiplication. Thus, in this case, we have that the deformation tensor acts on the initial vorticity along the random paths, and there is no action of the gradient noise term; a fortiori, this produces that the random lagrangian flow preserves the Lebesgue measure on  $R^3$ , as it can be easily verified. This action is the one that for 3D might produce the singularity of the solution.

In the case of  $R^2$ , the vorticity can be thought as a pseudoscalar, since  $\Omega_\tau(x) = \tilde{\Omega}_\tau(x) dx^1 \wedge dx^2$ , with  $\tilde{\Omega}_\tau : R^2 \rightarrow R$ , and being the curvature identically equal to zero, the vorticity equation is equivalent to a *scalar* diffusion equation:

$$\frac{\partial \tilde{\Omega}_\tau}{\partial \tau} = H_0(2\nu I, \frac{-1}{2\nu} u_\tau) \tilde{\Omega}_\tau \quad (91)$$

so that for  $\tilde{\Omega}_0 = \tilde{\Omega}$  given, the solution of the initial value problem is

$$\tilde{\Omega}(\tau, x) = E_x[\tilde{\Omega}(x_\tau^{\tau, x})] \quad (92)$$

This solution is qualitatively different from the previous case. Due to a geometrical duality argument, for 2D we have factored out completely the derived process in which the action of the deformation tensor on the initial vorticity is present.

Furthermore, the solution of equation (70) is (recall that  $X = I$ )

$$x_\tau^{g, x} = x + W_\tau, \quad (93)$$

and since  $\nabla X = 0$ , the derived process (see equation (71)) is constant

$$v_\tau^{g, x, v(x)} = v(x), \forall \tau \in [0, T]. \quad (94)$$

so that its influence on the velocity of the fluid can be factored out in the representation (71). Indeed, we have (see equation [66])

$$\tilde{u}_\tau(x) = \delta E_x^B[\int_0^\infty \frac{1}{2} \Omega_\tau(x + W_s) ds]. \quad (95)$$

In this expression we know from equation (72) that the expectation value is taken with respect to the standard Gaussian function,  $p^g(s, x, y) = (4\pi s)^{-\frac{n}{2}} \exp(-\frac{|x-y|^2}{4s})$ . Let us describe in further detail this solution separately for each dimension; for the details see [66]. For  $n = 2$  we have

$$u_\tau(x) = - \int_0^{\tau_e} \frac{1}{2s} E_x^B[\tilde{\Omega}_\tau(x + W_s) W_s^\perp] ds \quad (96)$$

where  $W_s^\perp = (W_s^1, W_s^2)^\perp = (W_s^2, -W_s^1)$ . Instead, for  $n = 3$  we have,

$$u_\tau(x) = - \int_0^{\tau_e} \frac{1}{2s} E_x^B [\tilde{\Omega}_\tau(x + W_s) \times W_s] ds \quad (97)$$

where  $\times$  denotes the vector product and  $W = (W^1, W^2, W^3) \in R^3$ . These representations were obtained as well in a rather involved non-invariant analytical approach by Busnello [54].

### 11.1 Integration of the Kinematic Dynamo Problem in Euclidean space

With the notations in this section, the kinematic dynamo problem in  $3D$  can be solved as follows. As for the vorticity, the magnetic field is for  $n = 3$  is a 2-form on  $R^3$ , or still by duality has an adjoint 1-form (so the argument turns to work out as well for 2D), or still a  $R^3$ -valued function, which with abuse of notation we still write as  $\tilde{\omega}(\tau, \cdot) : R^3 \rightarrow R^3$ , which from equation (92) we can write as

$$\tilde{\omega}(\tau, x) = E_x[\tilde{v}_\tau^{\tau, x, I} \omega_0(x_\tau^{\tau, x})], \quad (98)$$

where  $E_x$  denotes the expectation value with respect to the measure (if it exists) on  $\{x_\tau^{\tau, x} : \tau \geq 0\}$ , for all  $x \in R^3$ , and in the r.h.s. of expression (98) we have matrix multiplication. Thus, in this case, we have that the deformation tensor acts on the initial magnetic field along the random paths of the magnetized fluid particles. This action is the one that for  $3D$  produces the complicated topology of transported magnetic fields. This solution was obtained independently by Molchanov et al [50] and further applied in numerical simulations (see Ghill and Childress [51] and references therein). The important problems of the dynamo effect and of intermittency in magnetohydrodynamics, has been discussed in terms of random lagrangian flows and their Lyapunov stability, by Baxendale and Rozovskii [72].

## 12 The Navier-Stokes Equation is Purely Noise For Any Dimension Other than 1

### 12.1 Motivations

We have given up to now a derivation of diffusion processes starting from gauge theoretical structures, and applied this to give implicit representations for the invariant Navier-Stokes equations. These constructions were possible as they stemmed from the extremely tight relation existing between the metric-compatible Riemann-Cartan-Weyl connections, and the diffusion processes for differential forms, built untop of the diffusions for scalar fields. As we saw already this stemmed from the fact that there is a one-to-one correspondance

between said RCW connections and the scalar diffusion processes  $\{x_\tau : \tau \geq 0\}$  with drift given by  $\hat{Q}$  and diffusion tensor  $X$ . As we can easily check from expression (34), this construction is valid for  $n \neq 1$ . This could lead to conjecture that in a gauge theoretical setting and further applying stochastic analysis, one could do away with the drift, in any dimension other than 1. This is the case, as proved in a more general context of diffusions on a vector sub-bundle of the tangent space, by Elworthy-LeJan-Li [71]<sup>7</sup> Being this the case, then we can apply this construction to the Navier- Stokes equation, which thus in any dimension other than 1 would turn to be representable by random lagrangian paths which do not depend explicitly on the velocity of the fluid, since they would be purely noise processes.

Retaking the chain of structures previously described, we start by presenting an alternative representation for the RCW connections, to further describe the representation of the laplacians on scalars and its extension to differential forms, and the driftless random lagrangian flows.

## 12.2 The push-forward LeJan-Watanabe connection

Consider the surjection map  $K : M \times R^m \rightarrow TM$ , linear in the second variable, which we assume that it has a right inverse  $Y : TM \rightarrow M \times R^m$ . Here,  $Y$  is the adjoint of  $K$  with respect to the Riemannian metric on  $TM$  induced by  $K$ ,  $Y = K^*$ . Write  $K(x) = K(x, \cdot) : R^m \rightarrow TM$ . For  $u \in TM$ , let  $Z^u \in \Gamma(TM)$  (the space of sections of the tangent bundle) defined by

$$Z^u(x) = K(x)Y(\pi(u))u. \quad (99)$$

**Proposition 3.** There is a unique linear connection  $\tilde{\nabla}$  on  $M$  such that for all  $u_0 \in T_x M, x \in M$ , we have that

$$\tilde{\nabla}_{v_0} Z^{u_0} = 0. \quad (100)$$

It is the pushforward connection defined as

$$\tilde{\nabla}_{v_0} Z := K(x_0)d(Y(\cdot)Z(\cdot))(v_0), v_0 \in T_{x_0} M, Z \in \Gamma(TM), \quad (101)$$

---

<sup>7</sup>It is interesting to remark that in the monograph [71], the same chain of ideas developed here were pursued to give a general mathematical elaboration. As the reader might have noticed, the sequence is: linear connections with torsion (albeit skewsymmetric torsion in [71]), laplacians on scalars defined from these linear connections as generators of diffusion processes for scalar fields, the extension of these laplacians to generate diffusions of differential forms, and in Elworthy-LeJan-Li goes further to study the decomposition of noise and, finally the stability profile. (This last slab of this chain was applied, as stated above, to characterize the dynamo effect and intermittency in MHD [72].) While the line of research presented in this article was elaborated independently [10,59], having the Ito-Elworthy formula as the connecting thread just as in [71], the coincidence underlines the naturality of this chain of ideas. We would like to remark that the skew-symmetric torsion considered in [71] and references therein, in a context of studies in gravitation, is related to spin [57, 69].

where  $d$  is the usual derivative of the map  $Y(\cdot)Z(\cdot) : M \rightarrow R^m$ .

**Proof.** The above definition defines a connection. Let  $\hat{\nabla}$  be any linear connection on  $TM$ . We have

$$Z(\cdot) = K(\cdot)Y(\cdot)Z(\cdot). \quad (102)$$

Then, for  $v \in T_{x_0}M$ ,

$$\hat{\nabla}_v Z = K(x_0)d(Y(\cdot)Z(\cdot))(v) + \hat{\nabla}_v[K(\cdot)(Y(x_0)Z(x_0))] = \tilde{\nabla}_v Z + \hat{\nabla}_v Z^{Z(x_0)}. \quad (103)$$

Since  $\hat{\nabla}$  is a connection by assumption, and since the map

$$TM \times TM \rightarrow TM, (v, u) \mapsto \hat{\nabla}_v Z \quad (104)$$

gives a smooth section of the bundle  $Bil(TM \times TM; TM)$ , then  $\hat{\nabla}$  is a smooth connection on  $M$ . Taking  $\hat{\nabla} = \tilde{\nabla}$  we obtain a connection with the desired property.

**Theorem 11.** Let  $Y$  be the adjoint of  $K$  with respect to the induced metric on  $TM$  by  $K$ . Then,  $\tilde{\nabla}$  is metric compatible, where the metric is the one induced by  $X$  on  $TM$ , which we denote by  $\tilde{g}$ . Moreover, since  $M$  is finite-dimensional, any metric-compatible connection for any metric on  $TM$  can be obtained this way from such  $K$  and  $R^m$ .

**Proof:** We have

$$\begin{aligned} 2\tilde{g}(\nabla_v U, U) &= 2\tilde{g}(K(x_0)(d(Y(\cdot)U(\cdot)))(v), U(x_0)) \\ &= 2\tilde{g}(d(Y(\cdot)U(\cdot))(v), Y(x_0)U(x_0)) = d(\tilde{g}(U, U))(v), \end{aligned} \quad (105)$$

so that  $\tilde{\nabla}$  is indeed metric compatible. By the Narasimhan-Ramanan theorem on universal connections [87], any metric compatible connection arises like this. Indeed,  $\tilde{\nabla}$  is the pull-back of the universal connection over the Grassmannian  $G(m, n)$  of  $n$ -planes in  $R^m$  by the map  $x \mapsto [\text{Image}Y(x) : T_x M \rightarrow R^m]$ . In particular, the RCW connections arise from such a construction. c.q.d.

**Remarks 7.** Thus, any metric compatible connection, and in particular any RCW connection (recall that in Section 2 we imposed the condition of metric compatibility from the very beginning, or still, the last term in expression (34) ensures the metric compatibility of the RCW connections) can be introduced as a push-forward (also called LeJan-Watanabe) connection defined in terms of a *defining* map  $K$  for the connection.

Two connections,  $\nabla^a$  and  $\nabla^b$  on  $TM$  give rise to a bilinear map  $D^{ab} : TM \times TM \rightarrow TM$  such that

$$\nabla_V^a U = \nabla_V^b U + D^{ab}(V, U), U, V \in \Gamma(TM). \quad (106)$$

Choose  $\nabla^b = \nabla^g$ , the Levi-Civita connection of a certain Riemannian metric  $g$ . Consider instead of expression (106) for  $\nabla^a = \tilde{\nabla}$  of above:

$$\tilde{\nabla}_v U = \nabla_V^g U + \tilde{D}(V, U), \quad (107)$$



where we decompose  $\tilde{D}$  into

$$\tilde{D}(u, v) = A(u, v) + S(u, v), \quad (108)$$

where

$$A(u, v) = -A(v, u), S(u, v) = S(v, u). \quad (109)$$

Since the torsion tensors  $T^a$  and  $T^b$  of any two connections  $\nabla^a$  and  $\nabla^b$  respectively, are connected through the expression

$$T^a(u, v) + T^b(u, v) = D^{ab}(u, v) - D^{ab}(v, u). \quad (110)$$

which for the case of  $\nabla^b = \nabla^a$  as  $T^b = 0$ , we can write for  $D^{ab} = \tilde{D}$ , the identity

$$\tilde{T}(u, v) = \tilde{D}(u, v) - \tilde{D}(v, u) + 2A(u, v), \tilde{T} \equiv T^a. \quad (111)$$

Thus,

$$A(u, v) = \frac{1}{2}\tilde{T}(u, v), u, v, \in \Gamma(TM), \tilde{T} \equiv T^a. \quad (112)$$

Therefore, the decomposition in (107) is written in the form

$$\tilde{\nabla}_v U = \nabla_v^g U + \frac{1}{2}\tilde{T}(u, v) + S(u, v), u, v \in \Gamma(TM). \quad (113)$$

which for a metric compatible connection is nothing else than the original decomposition of the Cartan connection given in (10&11).

**Lemma 1.** A connection  $\tilde{\nabla}$  is metric-compatible if and only if the map  $\tilde{D}(v, \cdot) : TM \rightarrow TM$  is skew-symmetric for each  $v \in TM$ , i.e.

$$g(\tilde{D}(v, u_1), u_2) + g(\tilde{D}(v, u_2), u_1) = 0, u_1, u_2 \in \Gamma(TM). \quad (114)$$

Equivalently,

$$g(S(u_1, u_2), v) = \frac{1}{2}g(\tilde{T}(v, u_1), u_2) + \frac{1}{2}g(\tilde{T}(v, u_2), u_1). \quad (115)$$

Consequently, for  $U_1, U_2, V$  in  $\Gamma(TM)$ , we have

$$g(\tilde{D}(V, U_1), U_2) = \frac{1}{2}g(\tilde{T}(V, U_1), U_2) + \frac{1}{2}g(\tilde{T}(U_2, V), U_1) + \frac{1}{2}g(\tilde{T}(U_2, U_1), V), \quad (116)$$

which is decomposition (10).

**Proof.** Take  $V, U_1, U_2 \in \Gamma(TM)$ . Then,

$$\begin{aligned} d(g(U_1, U_2))(V) &= g(\nabla_V^g U_1, U_2) + g(U_1, \nabla_V^g U_2) \\ &= g(\nabla_V^g U_1, U_2) + g(U_1, \nabla_V^g U_2) - g(\tilde{D}(V, U_1), U_2) - g(U_1, \tilde{D}(V, U_2)). \end{aligned} \quad (117)$$

So,  $\tilde{\nabla}$  is metric compatible if and only if

$$g(\tilde{D}(V, U_1), U_2) + g(U_1, \tilde{D}(V, U_2)) = 0. \quad (118)$$

Now, writing  $\tilde{D} = A + S$  we get

$$g(A(V, U_1), U_2) + g(A(V, U_2), U_1) = -g(S(V, U_1), U_2) - g(S(V, U_2), U_1). \quad (119)$$

We now observe that for an alternating bilinear map  $L : TM \times TM \rightarrow TM$ ,

$$Cyl[g(L(v, u_1), u_2) + g(L(v, u_2), u_1)] = 0, \quad (120)$$

where  $Cyl$  denotes cyclic sum. Taking the cyclic sum in equation (119) and apply (120) to  $A$ , we thus obtain  $Cyl[g(S(V, U_1), U_2)] = 0$  which on further substituting in (119) we obtain

$$g(A(V, U_1), U_2) + g(A(V, U_2), U_1) = g(S(U_1, U_2), V). \quad (121)$$

### 12.3 The Trace-Torsion Is Dynamically Redundant in Any Dimension Other Than 1

Let us return to our original setting of Section 1. We assume a metric-compatible Cartan connection, which we now write as  $\tilde{\nabla}$  with torsion tensor  $\tilde{T}$ . The following result is a reduction of a more general result in [71], valid for sub-bundles of  $TM$ .

**Theorem 12.** Assume  $M$  has dimension bigger than 1. Consider the laplacian on 0-forms  $H_0(g, Q)$  where  $Q$  is the trace-torsion 1-form of  $\tilde{\nabla}$ ,

$$Q(u) = \text{trace } g(\tilde{T}(-, u), -). \quad (122)$$

Assume further that we can write the laplacian  $H_0(g, Q)$  in the Hormander form:

$$\frac{1}{2} \sum_{i=1}^m L_{V_i} L_{V_i} + L_Z |_{\Lambda^p T^* M} \quad (123)$$

where  $Z$  is a vectorfield on  $M$ ,  $V : M \times R^m \rightarrow TM$  is a smooth surjection, linear in the second variable, and  $V_i$  is defined by

$$V(x, e) = V(x)e = \sum_{i=1}^m V^i(x) \langle e, e_i \rangle, \quad (124)$$

with  $e_1, \dots, e_m$  the standard orthonormal basis for  $R^m$ . (Since  $\nabla^g$  is metric compatible, from Theorem 11 and the transformation rules between Stratonovich and Ito calculi, we can always introduce a defining map  $V$  for  $\nabla^g$  that gives such decomposition (c.f. [27])). Then, there exists a map  $K : M \times R^m \rightarrow TM$  linear on the second variable, such that the solution to the Stratonovich equation

$$dx_\tau = K(x_\tau) \circ dW_\tau, \quad (125)$$

has  $H_0(g, Q)$  for infinitesimal generator, i.e.

$$H_0(g, Q) = \frac{1}{2} \sum_{i=1}^m L_{K_i} L_{K_i} |_{C^\infty(M)}, \quad (126)$$

where  $C^\infty(M)$  denotes the real-valued smooth functions defined on  $M$ . In other words, the Ito s.d.e. given by (35) admits a driftless representation given by equation (125).

**Proof.** Set for the original drift vectorfield  $\hat{Q}$  (the  $g$ -conjugate of  $Q$ ), the decomposition

$$\hat{Q} = \frac{1}{2} \sum_{i=1}^m \nabla_{V^i}^g V^i - Z, \quad (127)$$

A connection  $\tilde{\nabla}$  suitable for this is such that

$$2A(u, v) = \tilde{T}(v, u) = \frac{2}{n-1} (u \wedge v) Q(x). \quad (128)$$

Consider a bundle map  $K : M \times R^m \rightarrow TM$  which gives rise to the metric compatible connection  $\tilde{\nabla}$  (theorem 11). Consider the s.d.e.

$$dx_\tau = K(x_\tau) \circ dW_\tau. \quad (129)$$

Its generator is (c.f. [27])

$$\frac{1}{2} \text{trace}(\nabla^g)^2 + \frac{1}{2} \sum_{i=1}^m \nabla^g K^i(K^i) \quad (130)$$

while by assumption we have

$$H_0(g, Q) = \frac{1}{2} \text{trace}(\nabla^g)^2 + \left( \frac{1}{2} \sum_{i=1}^m \nabla_{V^i}^g V^i - Z \right) = \frac{1}{2} \text{trace}(\nabla^g)^2 + \hat{Q} \quad (131)$$

The required result follows after we show

$$\sum_{i=1}^m \nabla^g K^i(K^i) = - \sum_{i=1}^m \tilde{D}(K^i, K^i) = \text{trace} \tilde{D}(-, -) \quad (132)$$

equals  $2\hat{Q}$ . For this we note that for all  $v \in TM$ ,

$$g\left(\sum_{i=1}^m \tilde{D}(K^i, K^i), v\right) = g\left(\sum_{i=1}^m S(K^i, K^i), v\right) = - \sum_{i=1}^m g(\tilde{T}(v, K^i), K^i) = 2g(\hat{Q}, v) \quad (133)$$

Consequently

$$\text{trace}(\nabla^g)^2 + \frac{1}{2} \sum_{i=1}^m \nabla^g(K^i)(K^i) = \text{trace}(\nabla^g)^2 + \hat{Q} = H_0(g, Q) \quad (134)$$

and the  $K$  so constructed is the required map.c.q.d.

If we further assume that there is an isometric embedding  $f : M \rightarrow R^m$ , then we have the remarkable fact that the driftless representation of the scalar laplacian is *also* valid for forms of arbitrary degree (c.f. section 2.4 in [71].), i.e. our original operators in (28) can be written as

$$H_p(g, Q) = \frac{1}{2} \sum_{i=1}^m L_{K_i} L_{K_i} |_{\Lambda^p T^*M}, \forall p \in \{0, \dots, n\},$$

where  $K$  is a defining map for the RCW connection determined by  $g$  and  $Q$ .

**Remarks 8.** Of course in the above construction, it is unnecessary to start with an arbitrary metric-compatible Cartan connection, only matters the trace-torsion as already proved.

## 12.4 Navier-Stokes Equations Is Purely Geometrical Noise In Any Dimension Other Than 1

We recall that for any dimension other than 1, the Navier-Stokes equation is a diffusion process which arises from a RCW connection of the form (34) with metric given by  $2\nu g$ , where  $g$  is the original metric defined on  $TM$ , and torsion restricted to the trace-torsion given by  $\frac{-1}{2\nu} u_\tau$ , where  $\tau \geq 0$ : we shall call this connection the Navier-Stokes connection with parameter  $\nu$ , which we shall denote as  $\nabla^{NS;\nu}$ . Thus the Christoffel coefficients of this connection are (c.f. expression (34))

$$\Gamma_{\beta\gamma}^\alpha = 2\nu \left\{ \begin{matrix} \alpha \\ \beta\gamma \end{matrix} \right\} + \frac{2}{(n-1)} \left\{ \begin{matrix} -1 \\ 2\nu \delta_\beta^\alpha u(\tau)_\gamma + \frac{1}{2\nu} g_{\beta\gamma} u(\tau)^\alpha \end{matrix} \right\} \quad (135)$$

Let us then consider a defining map  $K(\tau) : M \times R^m \rightarrow TM$ , for  $\tau \geq 0$  for such a connection; from theorem 11 we know it exists. Then, we can write

$$H_0(2\nu g, -\frac{1}{2\nu} u_\tau) = \frac{1}{2} \sum_{i=1}^m L_{K(\tau)_i} L_{K(\tau)_i} |_{C^\infty(M)}. \quad (136)$$

In particular, for isometrically embedding of  $M$ , it follows from our discussion above that we can rewrite the spatial term of the Navier-Stokes operator for the vorticity as

$$H_2(2\nu g, -\frac{1}{2\nu} u_\tau) = \frac{1}{2} \sum_{i=1}^m L_{K(\tau)_i} L_{K(\tau)_i} |_{\Lambda^2 T^*M},$$

and NS (61) takes the form of a purely geometrical- noise equation for the vorticity

$$\frac{\partial \Omega}{\partial \tau} = \frac{1}{2} \sum_{i=1}^m L_{K(\tau)_i} L_{K(\tau)_i} \Omega_\tau, \tau \geq 0.$$

Therefore, from Theorem 12 we conclude that:

**Theorem 13.** For smooth compact orientable  $n$ -manifolds without boundary, if we consider an isometric immersion  $f : M \rightarrow R^m$ , with  $n \neq 1$ , the random lagrangian representation given by (61) admits a representations as a Stratonovich s.d.e. without drift  $-\hat{u}_\tau$  term

$$dx_\tau = K_\tau(x(\tau)) \circ dW_\tau. \quad (137)$$

**Remarks 9.** Thus, we have gauged away in the velocity in the dynamical representation for the fluid particles. Of course, the new diffusion tensor  $K(\tau)$  ( $\tau \geq 0$ ) depends implicitly on the velocity of the fluid, on the kinematical viscosity and the metric  $g$ . Indeed,  $K(\tau)$  ( $\tau \geq 0$ ) can be computed from the knowledge of the Navier-Stokes connection with parameter  $\nu$ , by solving the equation

$$\nabla_v^{NS;\nu} Z = K_\tau(x)d(K_\tau^*(.)Z(.))(v), v \in T_x M, Z \in \Gamma(TM). \quad (138)$$

We can now return to give the random representations for NS for the vorticity, in terms of this driftless representation.

**Theorem 14.** Let  $f : M \rightarrow R^m$  be an isometric embedding of  $M$  (provided with a Riemannian metric  $g$ ) in Euclidean space, so that  $(2\nu)^{\frac{1}{2}}X = (2\nu)^{\frac{1}{2}}\text{grad } f$  is the diffusion tensor of a Riemann-Cartan- Weyl gradient diffusion generated by

$$H_0(2\nu g, -\frac{1}{2\nu}u_\tau) \equiv \frac{1}{2} \sum_{i=1}^m L_{K(\tau)_i} L_{K(\tau)_i}. \quad (139)$$

Consider

$$dx_s^{\nu,\tau,x} = K_{\tau-s}(x_s^{\nu,\tau,x}) \circ dW_s, x_0^{\nu,\tau,x} = x, \quad (140)$$

and the derived process

$$dv_s^{\nu,\tau,x,v(x)} = \nabla^g K_{\tau-s}(x_s^{\nu,\tau,x})(v_s^{\nu,\tau,x,v(x)}) \circ dW_s, v_0^{\nu,\tau,x,v(x)} = v(x) \in T_x M. \quad (141)$$

Then, NS for the vorticity admits the representation

$$\Omega_\tau(x)(\Lambda^2 v(x)) = E_x[\Omega_0(x_\tau^{\nu,\tau,x})(\Lambda^2 v_\tau^{\nu,\tau,x,v(x)})], \quad (142)$$

for given initial vorticity  $\Omega(0, x) = \Omega_0(x), x \in M$ .

**Remark 10.** This representation is none other than expression (68) rewritten in terms of the *driftless* representation for the random Lagrangian fluid flow and its Jacobian process given in (63 – 67), so there is actually no abuse of notation.

**Remarks 11.** While the fusion of stochastic calculus with gauge theoretical structures has set the method to derive in a rather simple way *all* the

representations for NS introduced in this article, Theorems 13&14 are most remarkable for reasons we would like to discuss in the following. It is well known that the existence of infinite-time and smooth solutions of NS is related to the fact that the energy dissipation (represented at the dynamical level by the term  $(2\nu)^{\frac{1}{2}} X(x(\tau))dW(\tau)$  appearing in the lagrangian particle paths (equation (62)), and further, by its covariant derivative coupling to the original vorticity along these paths in the representation for the vorticity) (see the first term in equation (66)) competes with the non-linearity of the equation. The physical effect of the nonlinearity is precisely the creation of energy due to the viscosity, which is described by the drift  $-\hat{u}_\tau$  at the fluid particle paths level, which further in the representations obtained in equation (68), appears as a coupling of the original vorticity with the fluid deformation tensor transported along the fluid particle paths which is further averaged over all the paths (see the second term in equation (66)). The physical description of this is that would the diffusion of energy prevail on the non-linear creation of energy, the infinite-time existence of the solutions would be ensured, and this would still entail the regularity of the solutions. In the other hand we have seen that the solutions in flat euclidean space in 2D differs from the one in 3D (both for which the gradient noise term vanishes and then the random lagrangian representation for NS yields a volume preserving diffeomorphism), in that in the former the coupling of the vorticity to the deformation tensor can be cancelled out while for the latter, this coupling appears clearly in the solution. Thus these representations run parallel to the established knowledge in which the existence of infinite-time and smooth solutions of NS for 2D are known, while for the 3D case remains open [61]. Returning to Theorems 13&14, it was proved that for NS the velocity can be incorporated into the diffusion tensor in this special representation and thus the coupling of the deformation tensor to the original vorticity *disappears*. Thus, for  $n$ -manifolds ( $n \neq 1$ ) only the gradient of the generalized noise term (which incorporates the velocity, naturally in a non-linear way) couples to the original vorticity, and NS turns out to be a *purely noise* process. Thus, theorems 13 and 14 show that in any dimension other than 1, in spite of the complexity that appears in 3D in contrast with 2D, their actual behavior in terms of their infinite-time existence and regularity of their solutions from this geometric-stochastic approach may *not* be regarded as radically different cases <sup>8</sup>.

Theorems 13&14 cannot be regarded as actual proofs of the infinite-time life of the solution flows for dimension 3, they rather point out to an original method that deserves further investigation regarding this elusive and difficult problem

---

<sup>8</sup>Perhaps this result should not be surprising, since after all for  $n$ -manifolds (in contrast with flat euclidean space) there is a coupling of the original vorticity to the deformation tensor, both for  $n = 2$  and 3, which is due to the curvature term built-in in the laplacian, and thus this common coupling originates in the fact that in this case, the Navier-Stokes operator incorporates the Ricci scalar curvature. Of course, curvature is a source for inertia and in fluid-dynamics, inertia is believed to be the source for the non-linearity of NS (c.f. the discussion in page 23, [81]).

(which has only be dealt with through mainly analytical considerations), and in principle is valid,<sup>9</sup> independently of the dimension of the manifold (other than 1).

**Remarks 12.** Similarly to theorems 13&14, and further replacing the magnetic diffusivity instead of the kinematical viscosity, we can represent the lagrangian random paths for the kinematic dynamo problem as a purely diffusive process, and integrate the kinematic dynamo in terms of the jacobian of this process. Similarly to NS for the vorticity, it appears that the coherent complex structures associated to the coupling of the fluid deformation tensor to the original magnetic field, can be accounted by a representation in which this field couples to a generalized diffusion tensor which depends on the fluid's velocity. Of course, these results are valid for arbitrary passive fields transported by the either perfect or viscous fluid.

### 13 Realization of the RCW Diffusions by ODE's

To realize the s.d.e's by o.d.e's it is mandatory to pass to the Stratonovich pre-prescription, which are well known to have the same transformation rules in stochastic analysis that those of classical flows [1,2]. The need for such approximations is obvious whenever the noise tensor is not trivial, and thus the random integration may be extremely difficult; in the trivial noise case it becomes superfluous, as we shall see when dealing with the Euclidean space case further below of this article. Thus, instead of eq. (35) we consider the Stratonovich s.d.e. (here denoted, as usual, by the symbol  $\circ$ ) for it given by :

$$dx(\tau) = X(x(\tau)) \circ dW(\tau) + b^{Q,X}(\tau, x(\tau))d\tau, \\ \text{where } b^{Q,X}(\tau, x(\tau)) = \hat{Q}(\tau, x(\tau)) + S(\nabla^g, X)(x(\tau)), \quad (143)$$

where the drift now contains an additional term, the Stratonovich correction term, given by  $S(\nabla^g, X) = \frac{1}{2}\text{tr}(\nabla_X^g X)$ , where  $\nabla_X^g X$ , the Levi-Civita covariant derivative of  $X$  in the same direction and thus it is an element of  $TM$ , so that in local coordinates we have  $S(\nabla^g, X)^\beta = \frac{1}{2}X_i^\beta \nabla_{\frac{\partial}{\partial x^\alpha}}^g X_i^\alpha$ . Now we also represent the jacobian flow using the Stratonovich prescription

$$d\tilde{v}(\tau) = \nabla^g X(x(\tau))(\tilde{v}(\tau)) \circ dW(\tau) + \nabla^g b^{Q,X}(\tau, x(\tau))(\tilde{v}(\tau))d\tau. \quad (144)$$

Now we shall construct classical flows to approximate the random flow  $\{x(\tau) : \tau \geq 0\}$ . We start by constructing a piecewise linear approximation of the Wiener

---

<sup>9</sup>This driftless representation is akin to the idea of a static Universe - a Form- as in the pre-Socratic philosophers Xhenophanes and Parmenides proposals [62], while the lagrangian representation presented here represents Heraclitus ideas with whom we associate the idea of dynamics. Remarkably, both conceptions appear to be equivalent in regards of a stochastic-geometrical representation of the Universe as long as it is not one-dimensional

process. Thus, we set for each  $k = 1, 2, \dots$ ,

$$W_k(\tau) = k\left[\left(\frac{j+1}{k} - \tau\right)W\left(\frac{j}{k}\right) + \left(\tau - \frac{j}{k}\right)W\left(\frac{j+1}{k}\right)\right],$$

$$\text{if } \frac{j}{k} \leq \tau \leq \frac{j+1}{k}, j = 0, 1, \dots \quad (145)$$

and we further consider the sequence  $\{x_k(\tau)\}_{k \in N}$  satisfying

$$\frac{dx_k(\tau)}{d\tau} = X(x_k(\tau))\frac{dW_k(\tau)}{d\tau} + b^{Q,X}(\tau, x_k(\tau)), \quad (146)$$

$$\frac{d\tilde{v}_k(\tau)}{d\tau} = \nabla^g X(x_k(\tau))(\tilde{v}_k(\tau))\frac{dW_k(\tau)}{d\tau} + \nabla^g b^{Q,X}(\tau, x_k(\tau))(\tilde{v}_k(\tau)), \quad (147)$$

$$\frac{dW_k(\tau)}{d\tau} = k\left[W\left(\frac{j+1}{k}\right) - W\left(\frac{j}{k}\right)\right] \text{ for } \frac{j}{k} < \tau < \frac{j+1}{k}, \quad (148)$$

(otherwise, it is undefined, ) so that  $\frac{dW_k(\tau)}{d\tau}$  exists for almost all values of  $\tau$  (a.e., in short in the following). Since  $\{W_k(\tau)\}_{k \in N}$  is differentiable a.e., thus  $\{x_k(\tau) : x_k(0) = x(0)\}_{k \in N}$  is a sequence of flows obtained by integration of well defined o.d.e's on  $M$  a.e., for all  $W \in \Omega$ . We remark that  $\{x_k(\tau)\}_{k \in n}$  depends on the (here chosen canonical) realization of  $W \in \Omega$  so that in rigour, we should write  $\{x_k(\tau, W, x_0)\}_{k \in N}$  to describe the flow; the same observation is valid for the approximation of the derivative flow below. With the additional assumption that  $X$  and  $Q$  are smooth, then the previous sequence defines for almost all  $\tau$  and for all  $W \in \Omega$ , a flow of smooth diffeomorphisms of  $M$ , and thus, the flow  $\{v_k(\tau) = (x_k(\tau), \tilde{v}_k(\tau)) : v_k(0) = (x(0), v(0))\}$  defines a flow of smooth diffeomorphisms of  $TM$ . In this case, this flow converges uniformly in probability, in the group of smooth diffeomorphisms of  $TM$ , to the the flow of random diffeomorphisms on  $TM$  defined by eqs. (35) and (39) [1,2,11].

Returning to KDE (and NSV), we can approximate eqs. (35) and (39) by taking the jacobian flow  $\{(x_k^{\tau,s,x}, \tilde{v}_k^{\tau,s,v(x)})\}_{k \in N}$  on  $TM$  given by

$$\frac{dx_k^{\tau,s,x}}{ds}(s) = [2\nu^m]^{\frac{1}{2}} X(x_k^{\tau,s,x})\frac{dW_k(s)}{ds} + b^{-u,X}(\tau - s, x_k^{\tau,s,x}), x_k^{\tau,0,x} = x, \quad (149)$$

$$\frac{d\tilde{v}_k^{\tau,s,v(x)}}{ds}(s) = [2\nu^m]^{\frac{1}{2}} \nabla^g X(x_k^{\tau,s,x})(\tilde{v}_k^{\tau,s,v(x)})\frac{dW_k(s)}{ds} + \nabla^g b^{-u,X}(\tau - s, x_k^{\tau,s,x})(\tilde{v}_k^{\tau,s,v(x)})ds,$$

$$\tilde{v}_k^{\tau,0,v(x)} = v(x) \in T_x M \quad (150)$$

$$\frac{dW_k(s)}{ds} = 2^k \left\{ W\left(\frac{[2^k s/\tau] + 1}{2^k}\right) - W\left(\frac{[2^k s/\tau]}{2^k}\right) \right\}, s \in [0, \tau], (\tau > 0), \quad (151)$$

with  $[z]$  the integer part of  $z \in (0, 1]$ , is the Stroock & Varadhan polygonal approximation [11]. Thus, we can write the expression:

$$\tilde{\omega}_\tau(v^1(x) \wedge \dots \wedge v^{n-1}(x)) = \lim_{k \rightarrow \infty} E_x[\omega_0(x_k^{\tau,\tau,x})(\tilde{v}_k^{\tau,\tau,v^1(x)} \wedge \dots \wedge \tilde{v}_k^{\tau,\tau,v^{n-1}(x)})] \quad (152)$$



By replacing  $\nu^m$  by  $\nu$  we have the approximations of the representations of NSV. We can proceed identically for the Poisson-de Rham equation, for which in account of eqs. (69) and (70) we have to substitute  $2\nu^m X$  by  $X$  and  $b^{-u,X} \equiv b^{0,X}$ , the latter being the Stratonovich correction term.

**Remarks 1.** There is not an unique construction for the approximation of these random diffeomorphisms by o.d.e.'s; indeed, the noise term can be alternatively presented in terms of the extension of the Cartan development method, as a sequence of polygonal geodesic paths [89]. Furthermore, in the case of manifolds being immersed in Euclidean space (which will be the case further below) and complete (autoparallels exist for any  $\tau$ ), the latter construction can be extended to a unified setting in which the random diffeomorphisms of a RCW diffusion can be realized (with convergence in probability) by sequences of polygonal autoparallel paths, i.e. smooth a.e. curves of the form  $\frac{\nabla^2 x(\tau)}{\partial \tau^2} = 0$ , where  $\nabla$  is a RCW connection. These approximations are irreversible per se in distinction with the above ones, since autoparallels just like geodesics can focus in a point; they can be constructed through the image of the exponential map of  $\nabla$  as the image of the parallel random transport by  $\nabla$  of a family of linear frames in  $TM$ ; the presentation of these constructions would increase greatly the length of this article, and can be found in a somewhat long and intricate presentation in Chapter 8, of the masterpiece due to Bismut [89]. This is of great importance, as it allows to establish an original understanding of the role of the autoparallels of  $\nabla$  as we shall argue next. Firstly, autoparallels are not the paths followed by spinless particles submitted to an exterior gravitational field described by a linear connection with torsion (the latter a common mistake as in [94]), or more restricted, a RCW connection, which is the geodesic flow as proved independantly of any lagrangian nor Hamiltonian dynamics [57]. This resulted from applying the ideas of E. Cartan's classical developing method and symplectic geometry, to derive the dynamics of relativistic spinning test-particles on exterior gravitational fields turned out to be an outstanding success of this approach, yielding extensions of the well known Papapetrou-Dixon-Souriau equations [57]. So RCW autoparallel polygonal a.e. smooth paths provide approximations of the random continuous of RCW diffusions (or still, of the Feynman path integral representation of their transition density), which as we already remarked, not necessarily should be thought as spinless particles, furthermore, vis a vis the construction of a theory of supersymmetric systems which have these motions as their support for the motions of arbitrary degree differential forms; we shall address the latter problem in the next Section. <sup>10</sup>

---

<sup>10</sup>Most remarkably, in the path integral representation due to Kleinert of the classical action for a scalar path on a time-sliced Euclidean space which through anholonomic coordinate transformation acquires both torsion and curvature, the classical motions appear to be autoparallels and by applying discretization on them, a short-time- $t$  Feynman propagator has been built for *arbitrary*  $Q$  which yields the non-relativistic Schroedinger equation where the Schroedinger operator is the non-relativistic version of our present  $H_0(g, Q)$ . Yet, in this work,

## 14 KDE and Random Symplectic Diffusions

Starting with a general RCW diffusion of 1-forms generated by  $H_1(g, Q)$ , we introduce a family of Hamiltonian functions,  $\mathcal{H}_k (k \in N)$  defined on the cotangent manifold  $T^*M = \{(x, p)/p : T_x M \rightarrow R \text{ linear}\}$  by

$$\mathcal{H}_k = \mathcal{H}_{X,k} + \mathcal{H}_Q, \quad (153)$$

with (in the following  $\langle -, - \rangle$  denotes the natural pairing between vectors and covectors)

$$\mathcal{H}_{X,k}(x, p) = \langle p, X(x) \rangle, \frac{dW_k}{d\tau}, \quad (154)$$

where the derivatives of  $W_k$  are given in eq. (151), and

$$\mathcal{H}_Q(x, p) = \langle p, b^{Q,X}(x) \rangle. \quad (155)$$

Now, we have a sequence of a.a. classical Hamiltonian flow, defined by integrating for each  $k \in N$  the a.a. system of o.d.e.'s

$$\frac{dx_k(\tau)}{d\tau} \equiv \frac{\partial \mathcal{H}_k}{\partial p_k} = X(x_k(\tau)) \frac{dW_k}{d\tau} + b^{Q,X}(x_k(\tau)), \quad (156)$$

$$\begin{aligned} \frac{dp_k(\tau)}{d\tau} &= -\frac{\partial \mathcal{H}_k}{\partial x_k} = -\langle p_k(\tau), \nabla^g X(x_k(\tau)) \rangle, \frac{dW_k(\tau)}{d\tau} \rangle \\ &- \langle p_k(\tau), \nabla^g b^{Q,X}(\tau, x_k(\tau)) \rangle. \end{aligned} \quad (157)$$

---

the rule for discretization is the Hanggi-Klimontovich (post-point) rule and thus it is not Ito's (middle point) nor the Stratonovich (pre-point) rules; see chapters 10 & 11 [94]. Now, the appearance in the present article of  $H_0(g, Q)$  as the differential generator of a diffusion process in terms of which the whole theory is constructed, has to do with the need of a diffeomorphism invariant description of a diffusion process and its generator, which requires the introduction of a linear connection [89], here a RCW connection whose laplacian is  $H_0(g, Q)$ . Such an approach fixes the discretization rule to be Ito's, and thus the Brownian integral of the theory is given by the random integral flow of Ito's eq. (35), and thus the Feynman integral which corresponds by analytical continuation on  $\tau$  of the flow of eq. (35) still corresponds to a medium-point rule. In the remarkable computational work due to Kleinert (which has a number of intriguing postulates for the definition of the Feynman measure such as a so-called principle of democracy between differentials and increments; see page 335 in [94]), no connection is made between diffusion processes, the Schroedinger wave function and the exact term of  $Q$ , as it shall appear in the accompanying article to the present one. Another result of this approach is that it will yield a modification of the (controversial) coefficient affecting the metric scalar curvature term (see [94] and references therein), which in the accompanying chapter of this book due to the author, will be associated with a generalization of Bohm's quantum potential in a relativistic setting. We would like to remark that in a recent formulation of a 1 + 1-dimensional relativistic theory of Brownian motion in phase space, it is claimed that when studying the equilibrium distribution of a free Brownian particle submitted to a heat bath, the post-point rule is the one that leads to the relativistic Maxwell distribution for the velocities; see J. Dunkel and P. Hanggi, arXiv:cond-mat/0411011.

which preserves the canonical 1-form  $p_k dx_k = (p_k)_\alpha d(x_k)^\alpha$  (no summation on  $k$ !), and then preserves its exterior differential, the canonical symplectic form  $S_k = dp_k \wedge dx_k$ . We shall denote this flow as  $\phi^k(\omega, \cdot)$ ; thus  $\phi_\tau^k(\omega, \cdot) : T_{x_k(0)}^* M \rightarrow T_{x_k(\tau)}^* M$ , is a symplectic diffeomorphism, for any  $\tau \in R_+$  and  $\omega \in \Omega$ . Furthermore, if we consider the contact 1-form [95] on  $R \times T^* M$  given by  $\gamma_k := p_k dx_k - \mathcal{H}_{X,k} d\tau - \mathcal{H}_{\hat{Q}} d\tau, \forall k \in N$ , we obtain a classical Poincaré-Cartan integral invariant: Let two smooth *closed* curves  $\sigma_1$  and  $\sigma_2$  in  $T^* M \times \{\tau = \text{constant}\}$  encircle the same tube of trajectories of the Hamiltonian equations for  $\mathcal{H}_k$ , i.e. eqs. (156) and (157); then  $\int_{\sigma_1} \gamma_k = \int_{\sigma_2} \gamma_k$ . Furthermore, if  $\sigma_1 - \sigma_2 = \partial\rho$ , where  $\rho$  is a piece of the vortex tube determined by the trajectories of the classical Hamilton's equations, then it follows from the Stokes theorem [95] that

$$\int_{\sigma_1} \gamma_k - \int_{\sigma_2} \gamma_k = \int_{\sigma_1} p_k dx_k - \int_{\sigma_2} p_k dx_k = \int_{\rho} d\gamma_k = 0. \quad (158)$$

Returning to our construction of the random Hamiltonian system, we know already that for  $X$  and  $\hat{Q}$  smooth, the Hamiltonian sequence of flows described by eqs. (156) and (157) converges uniformly in probability in the group of diffeomorphisms of  $T^* M$ , to the random flow of the system given by eqs. (143) and (144) and

$$dp(\tau) = -\langle p(\tau), \nabla^g X(x(\tau)) \rangle \circ dW(\tau) - \langle p(\tau), \nabla^g b^{Q,X}(\tau, x(\tau)) d\tau \rangle \quad (159)$$

Furthermore this flow of diffeomorphisms is the mapping:  $\phi_\tau(\omega, \cdot, \cdot)(x, p) = (F_\tau(\omega, x), F_\tau^*(\omega, x)p)$ , where  $F_\tau^*(\omega, x)$  is the adjoint mapping of the jacobian transformation. This map preserves the canonical 1-form  $pdx$ , and consequently preserves the canonical symplectic 2-form  $S = d(pdx) = dp \wedge dx$ , and thus  $\phi_\tau(\omega, \cdot) : T_{x(0)}^* M \rightarrow T_{x(\tau)}^* M$  is a flow of symplectic diffeomorphisms on  $T^* M$  for each  $\omega \in \Omega$  [89]. Consequently,  $\Lambda^n S$  is preserved by this flow, and thus we have obtained the Liouville measure invariant by a random symplectic diffeomorphism. We shall write onwards, the formal Hamiltonian function on  $T^* M$  defined by this approximation scheme as

$$\mathcal{H}(x, p) := \langle p, X(x) \rangle, \frac{dW_\tau}{d\tau} + \mathcal{H}_{\hat{Q}}(x, p). \quad (160)$$

We proceed now to introduce the random Poincaré-Cartan integral invariant for this flow. Define the formal 1-form by the expression

$$\gamma := p dx - \mathcal{H}_{\hat{Q}} d\tau - \langle p, X \rangle \circ dW(\tau), \quad (161)$$

and its formal exterior differential (with respect to the  $\mathcal{N} = T^* M$  variables only)

$$d_{\mathcal{N}} \gamma = dp \wedge dx - d_{\mathcal{N}} \mathcal{H}_{\hat{Q}} \wedge d\tau - d_{\mathcal{N}} \langle p, X \rangle \circ dW(\tau). \quad (162)$$

Clearly, we have a random differential form whose definition was given by Bismut [89]. Let a smooth  $r$ -simplex with values in  $R_+ \times T^*M$  be given as

$$\sigma : s \in S_r \rightarrow (\tau_s, x_s, p_s), \text{ where } S_r = \{s = (s_1, \dots, s_r) \in [0, \infty)^r, s_1 + \dots + s_r \leq 1\} \quad (163)$$

with boundary  $\partial\sigma$  the  $(r-1)$ -chain  $\partial\sigma = \sum_{i=1}^{r+1} (-1)^{i-1} \sigma^i$ , where  $\sigma^i$  are the  $(r-1)$  singular simplexes given by the faces of  $\sigma$ .  $\sigma$  can be extended by linearity to any smooth singular  $r$ -chains. We shall now consider the *random continuous*  $r$ -simplex,  $c$ , the image of  $\sigma$  by the flow of symplectic diffeomorphisms  $\phi$ , i.e. the image in  $R \times T^*M$

$$\phi(\tau_s, \omega, x_s, p_s) = (\tau_s, F_\tau(\omega, x_s), F_\tau^*(\omega, x_s)p_s), \text{ for fixed } \omega \in \Omega, \quad (164)$$

where  $F_\tau(\omega, x)$  and  $F_\tau^*(\omega, x)p$  are defined by eqs. (35), (37) and (159), respectively.

Then, given  $\alpha_0$  a time-dependant 1-form on  $\mathcal{N}$ ,  $\beta_0, \dots, \beta_m$  functions defined on  $R \times \mathcal{N}$ , the meaning of a random differential 1-form

$$\gamma = \alpha_0 + \beta_0 d\tau + \beta_i \circ dW^i(\tau), i = 1, \dots, m, \quad (165)$$

is expressed by its integration on a *continuous* 1-simplex

$$c : s \rightarrow (\tau_s, \phi_{\tau_s}(\omega, n_s)), \text{ where } n_s = (x_s, p_s) \in T^*M, \quad (166)$$

the image by  $\phi_\cdot(\omega, \cdot)$ , ( $\omega \in \Omega$ ) the random flow of symplectomorphisms on  $T^*M$ , of the smooth 1-simplex  $\sigma : s \in S_1 \rightarrow (\tau_s, (x_s, p_s))$ . Then,  $\int_c \gamma$  is a measurable real-valued function defined on the probability space  $\Omega$  in [89]. Now we shall review the random differential 2-forms. Let now  $\tilde{\alpha}_0$  be a time-dependant 2-form on  $\mathcal{N}$ , thus  $\tilde{\alpha}_0(\tau, n)$  which we further assume to be smooth. Furthermore, let  $\tilde{\beta}_0(\tau, n), \dots, \tilde{\beta}_m(\tau, n)$  be smooth time-dependant 1 forms on  $\mathcal{N}$  and we wish to give a meaning to the random differential 2-form

$$\gamma = \tilde{\alpha}_0 + d\tau \wedge \tilde{\beta}_0 + dW^1(\tau) \wedge \tilde{\beta}_1 + \dots + dW^m(\tau) \wedge \tilde{\beta}_m. \quad (167)$$

on integrating it on a continuous 2-simplex  $c : s \rightarrow (\tau_s, \phi_{\tau_s}(\omega, n_s))$ , or which we define it as a measurable real valued function on  $\Omega$  in [89]. To obtain the random Poincaré-Cartan invariant we need the following results on the approximations of random differential 1 and 2-forms by classical differential forms. Given as before  $\tilde{\alpha}_0$  a time dependant smooth 2-form on  $\mathcal{N}$  and time-dependant smooth 1-forms  $\tilde{\beta}_1, \dots, \tilde{\beta}_m$  on  $\mathcal{N}$ , there exists a subsequence  $k_i$  and a zero-measure  $\hat{\Omega}$  subset of  $\Omega$  dependant on  $\tilde{\alpha}_0, \tilde{\beta}_1, \dots, \tilde{\beta}_m$  such that for all  $\omega \notin \hat{\Omega}$ ,  $\phi_\cdot^{k_i}(\omega, \cdot)$  converges uniformly on any compact subset of  $R_+ \times R^{2n}$  to  $\phi_\cdot(\omega, \cdot)$  as well as all its derivatives  $\frac{\partial^l \phi_\cdot^{k_i}}{\partial n^l}(\omega, \cdot)$  with  $|l| \leq m$ , converges to  $\frac{\partial^l \phi_\cdot}{\partial n^l}(\omega, \cdot)$ , and for any smooth 2-simplex,  $\sigma : s \rightarrow (\tau_s, n_s)$  valued on  $R_+ \times \mathcal{N}$ , if

$$\gamma_k = \tilde{\alpha}_0 + d\tau \wedge (\tilde{\beta}_0 + \tilde{\beta}_1 \frac{dW_k^1}{d\tau} + \dots \tilde{\beta}_m \frac{dW_k^m}{d\tau}) \quad (168)$$

and if  $c^k$  is the 2-simplex given by the image of a smooth 2-chain by the a.a. smooth diffeomorphism  $\phi^k(\omega, \cdot)$  defined by integration of eqs. (156) and (157):  $c^k : s \rightarrow (\tau_s, \phi_{\tau_s}^k(\omega, n_s))$ , and  $c$  is the continuous 2-chain  $s \rightarrow (\phi_{\tau_s}(\omega, n_s))$ , then  $\int_{c^{k_i}} \gamma^{k_i}$  converges to  $\int_c \gamma$ . If instead we take a time-dependant 1-forms  $\alpha_0$  and time-dependant functions  $\beta_0, \dots, \beta_m$  on  $\mathcal{N}$  and consider the time-dependant 1-form on  $\mathcal{N}$  given by

$$\gamma_k = \alpha_0 + (\beta_0 + \beta_1 \frac{dW_k^1}{d\tau} + \dots + \beta_m \frac{dW_k^m}{d\tau}) d\tau \quad (169)$$

and for any a.e. smooth 1-simplex  $c^k : s \rightarrow (\tau_s, \phi_{\tau_s}^k(\omega, n_s))$  then there exists a subsequence  $k_i$  and a zero-measure set  $\hat{\Omega}$ , dependant of  $\alpha_0, \beta_0, \dots, \beta_m$ , such that for all  $\omega \notin \hat{\Omega}$ ,  $\phi^{k_i}(\omega, \cdot)$  converges uniformly over all compacts of  $R^+ \times R^{2n}$  with all its derivatives of order up to  $m$  to those of  $\phi(\omega, \cdot)$ , and if  $c$  is the continuous 1-simplex  $c : s \rightarrow (\tau_s, \phi_s(\omega, n_s))$ , then  $\int_{c^{k_i}} \gamma^{k_i}$  converges to  $\int_c \gamma$ , with  $\gamma$  defined in eq. (60).

Then, we can state the fundamental theorem of Stokes for this random setting, which is due to Bismut ([89], Theorem 3.4). Let  $c$  be a random continuous 2-simplex image of an arbitrary smooth 2-simplex by the flow  $\phi(\omega, \cdot)$ . There exists a zero-measure set  $\tilde{\Omega} \subset \Omega$  such that for any  $\omega \notin \tilde{\Omega}$ , then  $\int_c d\gamma = \int_{\partial c} \gamma$ , for any differential random 1-form  $\gamma$ .

In the following in the case defined by KDE, for which  $\hat{Q} = -\hat{u}$  with  $u$  a solution of NS or Euler equations, so that we set

$$\alpha_0 = p dx, \beta_0 = -\mathcal{H}_{-\hat{u}} \equiv \mathcal{H}_{\hat{u}}, \beta_i = -(2\nu^m)^{\frac{1}{2}} \langle p, X_i \rangle \equiv p_\alpha X_i^\alpha, i = 1, \dots, m, \quad (170)$$

where  $X : R^m \rightarrow TM$  with  $X(x) = \text{grad} f$  with  $f : M \rightarrow R^d$  is an isometric immersion of  $M$ , then

$$\begin{aligned} \gamma_{\text{KDE}} &= p dx + \mathcal{H}_{\hat{u}} d\tau - (2\nu^m)^{\frac{1}{2}} \langle p, X \rangle_i \circ dW^i(\tau) \\ &= p_\alpha (dx^\alpha + (b^{u,X})^\alpha d\tau - (2\nu^m)^{\frac{1}{2}} X_i^\alpha \circ dW^i(\tau)), \end{aligned} \quad (171)$$

is the random Poincaré-Cartan 1-form defined on  $R^+ \times \mathcal{N}$  for KDE. The Hamiltonian function for KDE is

$$\mathcal{H}(x, p) := [2\nu^m]^{\frac{1}{2}} \langle p, X(x) \rangle, \frac{dW_\tau}{d\tau} + \mathcal{H}_{-\hat{u}}(x, p), \quad (172)$$

with

$$\mathcal{H}_{-\hat{u}}(x, p) = p_\alpha (b^{-u,X})^\alpha = g^{\alpha\beta} p_\alpha (-u_\beta + \nu^m X_i^\alpha \nabla_{\frac{\partial}{\partial x^\beta}}^g X_i^\beta) \quad (173)$$

so that the Hamiltonian system is given by the system

$$dx(\tau) = [2\nu]^{\frac{1}{2}} X(x(\tau)) \circ dW(\tau) + b^{-u,X}(\tau, x(\tau)) d\tau, \quad (174)$$

$$\text{with } b^{-u,X}(\tau, x(\tau)) = \nu \nabla_X^g X(x(\tau)) - \hat{u}(\tau, x(\tau)) \quad (175)$$

$$\begin{aligned} dp(\tau) &= -(2\nu^m)^{\frac{1}{2}} \langle p(\tau), \nabla^g X(x(\tau)) \rangle \circ dW(\tau) \\ &\quad - \langle p(\tau), \nabla^g b^{-u,X}(\tau, x(\tau)) \rangle d\tau. \end{aligned} \quad (176)$$

As in the general case, we then obtain a Liouville invariant measure produced from the  $n$ -th exterior product of the canonical symplectic form. Substituting  $\nu^m$  by  $\nu$  we obtain the random Poincaré-Cartan invariant  $\gamma_{\text{NSV}}$  for NSV [91,92,96,97].

To obtain the invariants of the full Navier-Stokes equations [91,92,96,97], we have to consider in addition, the random Hamiltonian flow corresponding to the invariant Poisson-de Rham equation, i.e. eq.(60) which we rewrite here

$$d\tilde{x}(\tau) = X(\tilde{x}(\tau)) \circ dW(\tau) + S(X(\tilde{x}), g) \circ dW(\tau), \text{ and} \quad (177)$$

$$\begin{aligned} d\tilde{p}(\tau) &= -\langle \tilde{p}(\tau), \nabla^g X(\tilde{x}(\tau)) \rangle \circ dW(\tau) \\ &- \langle \tilde{p}(\tau), \nabla^g S(\nabla^g, X)(\tau, \tilde{x}(\tau)) d\tau \rangle. \end{aligned} \quad (178)$$

Furthermore this flow of diffeomorphisms preserves the canonical 1-form  $\tilde{p}d\tilde{x}$ , and consequently preserves the canonical symplectic 2-form  $S = d(pdx) = dp \wedge dx$ , and thus  $\phi_\tau(\omega, \cdot) : T_{x(0)}^*M \rightarrow T_{x(\tau)}^*M$  is a flow of symplectic diffeomorphisms on  $T^*M$  for each  $\omega \in \Omega$ . Consequently,  $\Lambda^n S$  is preserved by this flow, and thus we have obtained the Liouville measure invariant by a random symplectic diffeomorphism. We shall write onwards, the formal Hamiltonian function on  $T^*M$  defined by the approximation scheme for the formal Hamiltonian function

$$\mathcal{H}(\tilde{x}, \tilde{p}) := \langle \tilde{p}, X(\tilde{x}) \rangle, \frac{dW_\tau}{d\tau} + \langle p, S(\nabla^g, X)(x) \rangle. \quad (179)$$

We now proceed to introduce the random Poincaré-Cartan integral invariant for this flow. It is the 1-form

$$\gamma_{\text{Poisson}} := \tilde{p}d\tilde{x} - S(\nabla^g, X)(\tilde{x})d\tau - \langle \tilde{p}, X \rangle \circ dW(\tau). \quad (180)$$

This completes the construction of the random invariants for NS.

## 15 The Euclidean Case

To illustrate with an example, consider  $M = R^n$ ,  $f(x) = x$ ,  $\forall x \in M$ , and then  $X = \nabla f \equiv I$ , the identity matrix, as well as  $g = XX^\dagger = I$  the Euclidean metric, and  $\nabla^g = \nabla$ , is the gradient operator acting on the components of differential forms. Consequently, the Stratonovich correction term vanishes since  $\nabla_X X = 0$  and thus the drift in the Stratonovich s.d.e's. is the vector field  $b^{-u, X} = -\hat{u} = -u$  (we recall that  $\hat{u}$  is the  $g$ -conjugate of the 1-form  $u$ , but here  $g = I$ ).

We shall write distinctly the cases  $n = 2$  and  $n = 3$ . In the latter case we have that both the vorticity and the magnetic form, say  $\Omega(\tau, x)$  are a 2-form on  $R^3$ , or still by duality has an adjoint 1-form, or still a  $R^3$ -valued function, which with abuse of notation we still write as  $\tilde{\Omega}(\tau, \cdot) : R^3 \rightarrow R^3$ . Consider the

flows which integrates KDE (for NSV we simply substitute  $\nu^m$  by  $\nu$ ) is given by integrating the system of equations ( $s \in [0, \tau]$ )

$$dx^{\tau,s,x} = [2\nu^m]^{\frac{1}{2}} \circ dW(s) - u(\tau - s, x^{\tau,s,x}) ds, x^{\tau,0,x} = x, \quad (181)$$

$$d\tilde{v}^{\tau,s,v(x)} = -\nabla u(\tau - s, x^{\tau,s,x})(\tilde{v}^{\tau,s,v(x)}) ds, \tilde{v}^{\tau,0,v(x)} = v(x) \quad (182)$$

the second being an ordinary differential equation (here, in the canonical basis of  $R^3$  provided with Cartesian coordinates  $(x^1, x^2, x^3)$ ,  $\nabla u$  is the matrix  $(\frac{\partial u^i}{\partial x^j})$  for  $u(\tau, x) = (u^1(\tau, x), u^2(\tau, x), u^3(\tau, x))$ , which in account that since  $\int_0^\tau \circ dW(s) = W(\tau) - W(0) = W(\tau)$ , we integrate

$$x^{\tau,s,x} = x + [2\nu^m]^{\frac{1}{2}} W(s) - \int_0^s u(\tau - r, x^{\tau,r,x}) dr, s \in [0, \tau], \quad (183)$$

and

$$\tilde{v}^{\tau,s,v(x)} = e^{-s\nabla u(\tau-s, x^{\tau,s,x})} v(x) \quad (184)$$

so that the analytical representation for KDE (and alternatively for NSV) in  $R^3$  is

$$\tilde{\Omega}(\tau, x) = E_x[\tilde{v}^{\tau,\tau,I} \Omega_0(x^{\tau,\tau,x})], \quad (185)$$

where  $E_x$  denotes the expectation value with respect to the measure (if it exists) on  $\{x_r^{\tau,x} : \tau \geq 0\}$ , for all  $x \in R^3$ , which is a Gaussian function albeit not centered in the origin of  $R^3$  due to the last term in eq. (183) and in the r.h.s. of eq. (185) we have matrix multiplication. Thus, in this case, we have that the deformation tensor acts on the initial vorticity along the random paths. This action is the one that for 3D might produce the singularity of the solution of NS for 3D.

We finally proceed to present the random symplectic theory for KDE (and alternatively, NSV) on  $R^3$ . In account of eq. (55) with the above choices, the formal random Hamiltonian function is

$$\mathcal{H}(x, p) := [2\nu^m]^{\frac{1}{2}} \langle p, \frac{dW(\tau)}{d\tau} \rangle + \mathcal{H}_{-\hat{u}}(x, p), \quad (186)$$

with

$$\mathcal{H}_{-\hat{u}}(x, p) = -\langle p, u \rangle. \quad (187)$$

The Hamiltonian system is described by specializing eqs. (174 – 176), so that we obtain the Stratonovich s.d.e. for  $x(\tau) \in R^3, \forall \tau \geq 0$ :

$$dx(\tau) = [2\nu^m]^{\frac{1}{2}} \circ dW(\tau) - u(\tau, x(\tau)) d\tau, \quad (188)$$

and the o.d.e

$$dp(\tau) = -\langle p(\tau), \nabla u(\tau, x(\tau)) \rangle d\tau. \quad (189)$$

If we further set  $x(0) = x$  and  $p(0) = p$ , the Hamiltonian flow preserving the canonical symplectic form  $S = dp \wedge dx$  on  $R^6$  is given by

$$\phi_\tau(\cdot, \cdot)(x, p) = (x(\tau), p(\tau)) = (x + [2\nu^m]^{\frac{1}{2}}W(\tau) - \int_0^\tau u(r, x(r))dr, e^{-\tau \nabla u(\tau, x(\tau))}p)(190)$$

Finally, the Poincaré -Cartan 1-form takes the form

$$\gamma_{\text{KDE}} = \langle p, dx - ud\tau - (2\nu^m)^{\frac{1}{2}} \circ dW(\tau) \rangle, \quad (191)$$

and the Liouville invariant is  $S \wedge S \wedge S$ . This, completes the implementation of the general construction on  $3D$ , for KDE (alternatively, for NSV).

To complete our symplectic representations for NS, we still have to give the symplectic structure associated to eq. (60) (Poisson-de Rham) for both  $R^2$  and  $R^3$ . This structure is the same in both cases, the only difference is in the form of the random Liouville invariant. Indeed, the random Hamiltonian system for Poisson-de Rham is given by eqs. (177) and (178), which in the Euclidean case the former yields eq. (93), while the latter is  $d\tilde{p}(\tau) = 0$ , so that if  $\tilde{p}(0) = p$ , then the random symplectic flow for Poisson-de Rham equation is given by

$$\phi_\tau(\cdot, \cdot)(x, p) \equiv (\tilde{x}(\tau), \tilde{p}(\tau)) = (x + W(\tau), p), \quad (192)$$

and the Liouville invariant is  $\tilde{S} \wedge \tilde{S}$  for  $n = 2$ , and  $\tilde{S} \wedge \tilde{S} \wedge \tilde{S}$  for  $n = 3$ , where  $\tilde{S} = d\tilde{p} \wedge d\tilde{x}$  is the canonical symplectic form for both cases, for the Poisson-de Rham equation. In distinction with the random symplectic invariants for NSV, here the momentum is constant, and of course, the position variable does no longer depend manifestly on  $u$ .

**Remarks 13.** Geometrical-topological invariants in magnetohydrodynamics and hydrodynamics have been widely studied [9,56,70]. We have followed the presentation in [91,92,96] which lead to the random symplectic invariants of NS, hitherto unknown. The present approach applies as well to the random quantization of quantum mechanics through stochastic differential equations, as we shall present in the accompanying article, and thus we shall have random phase invariants which have been unnoticed till today.

## 16 Derivation of the Symplectic Structure for Perfect Fluids

We have seen that NS has an associated Hamiltonian function and a Liouville invariant, and thus we have in principle the basic elements to develop a statistical mechanics approach to NS. The purpose of this section, is to obtain the symplectic structure for the Euler equations from our perspective. Indeed, note that if we set  $\nu = 0$  we have a classical limit whose dynamics is described



by the characteristics curves defined by the integral curves of  $-\hat{u}$ , i.e. (minus) the velocity vector-field. Indeed, if we set the kinematical viscosity  $\nu$  to zero in eqs. (174 – 176) we obtain

$$\frac{dx(\tau)}{d\tau} = -\hat{u}(\tau, x(\tau)), \quad (193)$$

$$\frac{dp(\tau)}{d\tau} = -\langle p(\tau), \nabla^g u(\tau, x(\tau)) \rangle. \quad (194)$$

Now, on integrating eq. (193) with some given initial condition  $x(0)$ , we obtain a family (indexed by time) of classical diffeomorphisms of  $M$  which to  $x(0)$  associates the position  $x(\tau)$  of the fluid particles with velocity vector field given by  $-\hat{u}(\tau, x(\tau))$ ; in fact for each  $\tau$  this diffeomorphisms preserves the Riemannian volume since  $\hat{u}$  is divergenceless. Thus, it follows from our particular case for a perfect incompressible fluid obeying the Euler equations (set  $\nu = 0$  in eq. (57)), that the configuration space is given by the volume preserving diffeomorphisms of  $M$ , which we denote by  $\text{SDiff}(M)$  which is nothing else than the starting point the AEM theory; by contrast in the present approach the configuration space for NS are the random diffeomorphisms defined by the lagrangian flow described above, which is *not* volume preserving but in the special case of Euclidean space for which  $X = \text{Id}$ .

Now  $\text{SDiff}(M)$  is an infinite-dimensional Lie group, and we are interested -in following Arnold- in its Lie algebra, which is the set of divergenceless vector fields on  $M$ ,  $\text{SVect}(M)$  provided with the usual commutator. Arnold further considered the orbits of the coadjoint action of this group on the dual of the Lie algebra, as a Hamiltonian system whose Hamiltonian function is (c.f. definition 7.20 and Lemma-definition 7.21 in [56]) (following eq. (22) above)

$$\frac{1}{2}([u_\tau], [u_\tau]) = \frac{1}{2} \int_M g([\hat{u}_\tau], [\hat{u}_\tau]) \text{vol}_g, \quad (195)$$

where  $[u_\tau]$  denotes the equivalence class of all 1-forms on  $M$  of the type  $u_\tau + df$ , with  $\delta u_\tau = 0$  and some function  $f : M \rightarrow R$ , which is nothing else than

$$-\frac{1}{2} \int_M \mathcal{H}(x, [u_\tau]) \text{vol}_g := \frac{1}{2} \int_M \mathcal{H}_{[\hat{u}_\tau]}(x, [u_\tau]) \text{vol}_g, \quad (196)$$

which coincides with Arnold's energy function on  $\text{SVect}(M)^*$ , the dual Lie algebra of  $\text{SVect}(M)$ . From the minimal action principle Arnold obtained finally the geodesic equation in  $\text{SDiff}(M)$ . But we can obtain these equations directly in our setting if we further set  $p \equiv u$  in eq. (194), so that eqs. (193) and (194) turn to be the geodesic equation on  $\text{SDiff}(M)$ :

$$\frac{d^2 x(\tau)}{d\tau^2} + \nabla_{\hat{u}_\tau(x)}^g u_\tau(x(\tau)) = 0, \quad (197)$$

which in account of the identity

$$\nabla_{\dot{u}_\tau(x)}^g u_\tau(x) = L_{\dot{u}_\tau(x)} u_\tau(x) - \frac{1}{2} d(|u_\tau|^2), \quad (198)$$

we get the Euler equation (see pages 37, 38 in [56])

$$\frac{\partial u}{\partial \tau} + L_{\dot{u}_\tau(x)} u_\tau(x) = \frac{1}{2} d(|u_\tau|^2) \quad (199)$$

identically to set  $\nu = 0$  in NS. Note here that the pressure function  $\tilde{p}$  reduces to be (modulo an additive constant)  $-\frac{1}{2}|u_\tau|^2$ , minus the kinetic energy term of  $u_\tau$ , and the non-appearance of itself the  $-d\tilde{p}$  term in the r.h.s. of eq. (199) is produced by the fact that our random flows for NS have been constructed for the vorticity equation, for which there is no pressure term since  $d^2\tilde{p} = 0$ ; otherwise stated, to obtain the Euler equation we have taken  $u_\tau \in [u_\tau]$  such that  $f \equiv 0$ , and thus the total pressure is

$$f - \frac{1}{2}(|u_\tau|^2) = -\frac{1}{2}|u_\tau|^2$$

(see comments in first paragraph after Remark 7.22 in [56]).

**Remarks 13.** Thus, we have proved that the random symplectic approach to NS yields the classical symplectic approach to the Euler equation, in the case of null viscosity, as a particular result of the kinematics of the random viscous flow. We may remark that Arnold's approach stops short of discussing analytical representations for NS, yet his symplectic approach has been extended by the addition of Wiener processes, to give the representations of NS for the flat torus, by Gliklikh [63]. Probably the present work could be seen as a natural addendum to the joint work by Arnold and Khesin [56], in which prior to the introduction of the (random) symplectic geometry, one has to introduce first the stochastic differential geometry from which it stems, both aspects being absent in this beautiful treatise. We have derived through the association between RCW connections and generalized Brownian motions, the most general implicit analytical representations for NS, in the case of manifolds without boundaries. The case with smooth boundaries and Euclidean semi-space has been treated completely in [ ]. Furthermore, in the case without boundary, we have proved that the interaction representation of the solutions of NS, and in general of diffusion processes, in which the trace-torsion plays the major role of describing the average motions, can be gauged away (for any dimension other than 1) and transformed into an equivalent representations in which the trace-torsion enters in the definition of the noise-tensor, as if the random motion would be completely free [5]! Yet, concerning NS the present treatment is still unsatisfactory, since the representations are implicit, since we have not presented a theory in which we would decouple the velocity 1-form (the gauge potential) and the vorticity 2-form (the 'curvature' field strength). We would like to suggest that

if this problem might have a solution, then it should be approached through the application of Clifford algebras and Clifford analysis, in which through the Dirac operator whose square is the NS laplacian, we could integrate the theory in terms of the vorticity alone. This would be similar to the Maxwell equation as a single equation for the electromagnetic field strength (a 2-form, and not in terms of the electromagnetic potential 1-form), as we shall describe in the accompanying article that follows the present one. We have discussed in a previous chapter in this book, that the Schroedinger equation in spatial 2D, can be transformed into the Navier-Stokes equations, and that the Born probability density maps into the enstrophy. In forthcoming articles, we shall present the relations between fluid-dynamics and turbulence, electrodynamics and quantum mechanics.

The method of integration applied in this article is the extension to differential forms of the method of integration (the so-called martingale problems) of elliptic and parabolic partial differential equations for scalar fields [24,31,73]. The remarkable key for this method is, as we have shown for all given representations, the Ito-Elworthy formula of stochastic analysis for differential forms in its various expressions.<sup>11</sup>

In distinction with the Reynolds approach in Fluid Mechanics<sup>12</sup> which has the feature of being non-invariant, in the present approach, the invariance by the group of space-diffeomorphisms has been the key to integrate the equations, in separating covariantly the fluctuations and drift terms and thus setting the integration in terms of covariant martingale problems. The role of the RCW connection is precisely to yield this separation for the diffusion of scalars and differential forms, and thus the role of the differential geometrical structure is essential. Yet, as we have shown, we can introduce a push-forward description of the RCW connection, such that via stochastic analysis we can gauge away the trace-torsion in any dimension other than 1, to obtain equivalent purely noise representations for NS. The noise is purely geometrical, incorporating the parameters which characterize the random lagrangian flow for *scalars* of NS in its definition.

A new approach to NS as a (*random*) dynamical system appears. Given a stationary measure for the *random* diffeomorphic flow of NS given by the stationary flow of NS, one can construct the state space of this flow and further, its *random* Lyapunov spectra [72,76,77]. Consequently, assuming ergodicity of this measure, one can conclude that the moment instability of the flow is related to a cohomological property of  $M$ , namely the existence of non-trivial harmonic one-forms  $\phi$ , which are preserved by the vectorfield  $\hat{u}$  of class  $C^2$ , i.e.  $L_{\hat{u}}\phi = di_{\hat{u}}\phi = 0$ ; see page 61 in [27]. We also have the random flows  $\{v_\tau \wedge v_\tau : \tau \geq 0\}$  and  $W_\tau^{2,-\hat{u}_0}$  on  $TM \wedge TM$  of Theorem 7 and Theorem 10 respectively,

<sup>11</sup>Furthermore, this approach can be extended to the case of smooth manifolds with smooth boundaries, yet due to length limitations, we shall discuss it elsewhere [67].

<sup>12</sup>A generalization of the Reynolds approach to random lagrangian flows, completed with the  $k - \epsilon$  theory, is the basis for the studies on turbulence by Pope [75].

which integrate the heat equation for the vorticity. Concerning these flows, the stability theory of NS (57) requires an invariant measure on a suitable subspace of  $TM \wedge TM$  and further, the knowledge of the spectrum of the one-parameter family of operators depending on  $\nu$ ,  $H_2(2\nu g, -\frac{1}{2\nu}u_\tau)$ ; alternatively, one could use the expression for the Navier-Stokes operator provided by Theorem 13. These operators may play the role of the Schroedinger operators in Ruelle's theory of turbulence, which were introduced by linearising NS for the velocity as the starting point for the discussion of the instability theory; see article in pages 295 – 310 in Ruelle [48].

As well known, the stability theory is usually encountered in the framework of a major approach to turbulence in fluids, that of *classical* dynamical systems presenting chaotic behavior. In this approach, the aim is to construct of a low-dimensional non-random model that describes the asymptotic expression of typical solutions of NS under adequate boundary and regularity conditions. Bounds on the dimension of these attractors for NS have been computed [48,74,83,84], yet the actual construction of the dynamics of these attractors from first principles is an open problem under study for NS [81]. More generally, little is known about these low dimensional (inertial manifolds) which describe this asymptotic dynamics for infinite-dimensional dynamical systems [74]. Of course, ad-hoc reductions of NS such as the one that leads to the Lorenz ordinary differential equations [84] have been useful to give a qualitative description. Remarkably enough, the random approach to NS that we have presented, can also be encountered in low dimensional chaotic classical dynamics. Indeed, it has been proved that the solution of o.d.e's of the form of the Lorenz system, converges (in the sense of weak convergence of processes) to the solution of stochastic differential equations, and thus representable by a RCW connection. This has been proved for the case of inertial manifolds defined on compact manifolds with partial dynamics described by complete vector fields generating an axiom A flow, having further a non-periodic attractor and with initial conditions distributed according to the Sinai-Ruelle-Bowen measure [85]. Thus, also the low dimensional chaotic classical dynamics approach to turbulence has the same type of structure as the full infinite-dimensional random flows presented in this article. <sup>13</sup>

Finally, it has been established numerically that turbulent fluids resemble the random motion of dislocations [4]. In the differential geometric gauge theory of crystal dislocations, the torsion tensor is the dislocation tensor [12,86], and our presentation suggests that this analogy might be established rigorously from the perspective presented here.

We would like to remark that averaged extensions of the equations of Euler and Navier-Stokes are being currently investigated. In these works the averaging is in the sense of an ensemble of initial conditions taken in an appropriate

---

<sup>13</sup>In fact our representations can be realized by rather standard methods in terms of ordinary differential equations on  $M$ , thus guaranteeing effectively low dimensional realizations [88].

analytical space. Remarkably as well, the extension of the Euler equations can be derived as the geodesic flow of an extended metric on the manifold of volume preserving diffeomorphisms of  $M$ ; thus this program is an extension of the Arnold-Ebin-Marsden approach (see [64,65]). As well in the past years, Gliklikh has integrated NS for a viscous fluid in the flat torus, as a stochastic perturbation of the geodesic Euler-flow [63], thus extending the classical approach of Arnold-Ebin-Marsden.

## References

- [1] A. Chorin, *Turbulence and Vorticity*, Springer, New York, (1994);
- [2] K. Gustafson & J. Sethian (eds.), *Vortex Methods and Vortex Motions*, SIAM, Philadelphia, (1991).
- [3] M. Lesieur, *Turbulence in Fluids*, 3rd.ed., Kluwer, Dordrecht, (1997)
- [4] M. Lesieur, *La Turbulence*, Presses Univ. de Grenoble, (1994).
- [5] A. Chorin & J. Marsden, *A Mathematical Introduction to Fluid Mechanics*, Springer, New York/Berlin, (1993).
- [6] C. Marchioro & M. Pulvirenti, *Mathematical Theory of Incompressible Non-viscous Fluids*, Springer, New York/Berlin, (1994).
- [7] R. Temam, *Navier-Stokes Equations*, North-Holland, Amsterdam, (1977).
- [8] U. Frisch, *Turbulence. The legacy of A.N. Kolmogorov*, Cambridge Univ. Press, (1996).
- [9] D. Ebin & J. Marsden, *Ann. Math.* **92**, 102-163 (1971)
- [10] a. D. Rapoport, *Int. J. Theor. Physics* **35** No.10 (1997), 2127-2152; b. **30**, (1)1, 1497 (1991); c. **35**,(2),287 (1996)
- [11] P. Malliavin, *Géométrie Différentielle Stochastique*, Les Presses Univ. Montréal (1978).
- [12] K.D. Elworthy, *Stochastic Differential Equations on Manifolds*, Cambridge Univ. Press, Cambridge, (1982).
- [13] J. Eells & K.D. Elworthy, Stochastic dynamical systems, in *Control Theory and topics in Functional Analysis, v.III*, ICTP- Trieste, International Atomic Energy Agency, Vienna, 1976.
- [14] N. Ikeda & S. Watanabe, *Stochastic Differential Equations on Manifolds*, North-Holland/Kodansha, Amsterdam/Tokyo, (1981).

- [15] K. Ito, The Brownian motion and tensor fields on Riemannian manifolds, in *Proc. the Intern. Congress of Mathematics*, Stockholm, 536-539, 1963.
- [16] O.Reynolds, On the dynamical theory of turbulent incompressible fluids and the determination of the criterion, *Philosophical Transactions of the Royal Society of London A*, **186**, 123-161, (1894)
- [17] A. S. Monin & A. M. Yaglom, *Statistical Fluid Mechanics, vol. II*, J. Lumley (ed.), M.I.T. Press, Cambridge (MA) (1975).
- [18] J. Lumley, *Stochastic Tools in Turbulence*, Academic Press, New York, (1970).
- [19] S.A. Orszag, Statistical Theory of Turbulence, in *Fluid Dynamics, Les Houches 1973*, 237-374, Eds. R. Balian & J.Peube, Gordon and Breach, New York, (1977).
- [20] L.Onsager, Statistical Hydrodynamics, *Nuovo Cimento* **6**(2), 279-287, (Suppl.Serie IX), 1949.
- [21] D. Rapoport, The Geometry of Quantum Fluctuations, the Quantum Lyapounov Exponents and the Perron-Frobenius Stochastic Semigroups, in *Dynamical Systems and Chaos, Proceedings (Tokyo, 1994)*, Y.Aizawa (ed.), World Sc. Pubs., Singapore, 73-77,(1995).
- [22] D. Rapoport, Covariant Non-linear Non-equilibrium Thermodynamics and the Ergodic theory of stochastic and quantum flows, in *Instabilities and Non-Equilibrium Structures, vol. VI*, p.259-270, Proceedings, E. Tirapegui and W. Zeller (eds.), Kluwer, (2000).
- [23] H. Kleinert, *The Gauge Theory of Defects, vols. I and II*, World Scientific Pubs., Singapore,(1989).
- [24] H. Kunita, *Stochastic Flows and Stochastic Differential Equations*, Cambridge Univ. Press, (1994).
- [25] S. Kobayashi & K.Nomizu, *Foundations of Differentiable Geometry I*, Interscience, New York, (1963).
- [26] D. Rapoport, Torsion and non-linear quantum mechanics, in *Group XXI, Physical Applications and Mathematical Aspects of Algebras, Groups and Geometries, Proceedings (Clausthal, 1996)*, H.D. Doebner et al (edts.), World Scientific, Singapore, (1997). ibidem, Riemann-Cartan-Weyl Geometries, Quantum Diffusions and the Equivalence of the free Maxwell and Dirac-Hestenes Equations, *Advances in Applied Clifford Algebras*, vol. **8**, No.1, p. 129-146, (1998).

- [27] K.D. Elworthy, Stochastic Flows on Riemannian Manifolds, in *Diffusion Processes and Related Problems in Analysis*, M.A. Pinsky et al (eds.), vol.II, Birkhauser,(1992).
- [28] Fulling, S.A., *Aspects of Quantum Field Theory in Curved Space-Time*, Cambridge U.P., (1989)
- [29] M. Berger, P. Gauduchon & E. Mazet, *Le spectre d'une variété riemannienne*, Springer LNM **170**, (1971).
- [30] R. Durrett, *Brownian Motion and Martingales in Analysis*, Wadsworth, Belmont,(1984).
- [31] R. Pinsky, *Positive Harmonic Functions and Diffusions*, Cambridge University Press, (1993).
- [32] B. Simon, Schroedinger Semigroups, *Bull. AMS (new series)* **7**, 47-526, 1982.
- [33] M. Nagasawa, *Schroedinger Equations and Diffusion Theory*, Birkhauser, Basel, (1994).
- [34] E. Nelson, *Quantum Fluctuations*, Princeton Univ. Press, Princeton, New Jersey, (1985).
- [35] Y. Takahashi & S. Watanabe, The probability functionals (Onsager-Machlup functions) of diffusion processes, in *Durham Symposium on Stochastic Integrals*, Springer LNM No. **851**, D. Williams (ed.), (1981).
- [36] M.I.Vishik & A. Fursikov, *Mathematical Problems of Statistical Hydrodynamics*, Kluwer Academic Press, 1989.
- [37] L.C. Rogers & D.Williams, *Diffusions, Markov Processes and Martingales, vol. II*, John Wiley, New York, 1989.
- [38] M.T. Landhal & E. Mollo-Christensen, *Turbulence and Random Processes in Fluid Mechanics*, Cambridge Univ. Press, 1994.
- [39] A. Majda, Incompressible Fluid Flow, *Communications in Pure and Applied Mathematics* Vol.**XXXIX**, S-187-220, 1986.
- [40] P. Meyer, Géométrie stochastique sans larmes, in *Séminaire des Probabilités XVI, Supplement*, Lecture Notes in Mathematics 921, Springer-Verlag, Berlin, 165-207, 1982.
- [41] T. Bohr, M. Jensen, G.Paladini & A.Vulpiani, *Dynamical Systems Approach to Turbulence*, Cambridge Non-linear Series No.7, Cambridge Univ. Press, Cambridge,1998.

- [42] A.B. Cruzeiro & S. Albeverio, Global flows with invariant (Gibbs) measures for Euler and Navier-Stokes two dimensional fluids, *Communications in Mathematical Physics* **129** (1990), 431-444; ibidem Solutions et mesures invariantes pour des equations d evolution du type de Navier-Stokes, *Expo. Math.* **7** (1989), p.73-82.
- [43] S.A. Molchanov, Diffusion Processes and Riemannian Geometry, *Russian Mathematical Surveys* **30** (1975), 1-63.
- [44] F. Langouche, D. Roenkarts and E. Tirapegui, *Functional Integration and Semiclassical Expansions*, Reidel Publs. Co., Dordrecht (1981).
- [45] J. Leray, *Selected Works, vol. II*, Societ e Mathematique de France and Springer-Verlag, Berlin, 1998.
- [46] F. Hehl, J. Dermott McCrea, E. Mielke & Y. Ne'eman, Physics Reports vol. **258**, 1-157, 1995.
- [47] A. Friedman, *Stochastic Differential Equations and Applications, vol. I*, Academic Press, New York, (1975).
- [48] D. Ruelle (editor), *Turbulence, Strange Attractors and Chaos*, Series A on Nonlinear Science vol. 16, World Scientific (1995).
- [49] D. Rapoport, On the Geometry of Fluctuations, I,& II, in *New Frontiers of Algebras, Groups and Geometries, Proceedings (Monteroduni, 1995)*, G. Tsagas (ed), Hadronic Press, 1996.
- [50] S.A. Molchanov, A.A. Ruzmaikin and D.D. Sokoloff, "A Dynamo Theorem", *Geophys. Astrophys. Fluid Dynamics***30** (1984), 242.
- [51] M. Ghill and S.Childress, *Stretch, Twist and Fold*, Springer-Verlag, New York, 1995.
- [52] D. Elworthy and X.M. Li, Formulae for the Derivatives of Heat Semigroups, *J. of Functional Analysis* **125** (1994), 252-286.
- [53] M. Taylor, *Partial Differential Equations vol.III* , Springer Verlag, 1995.
- [54] B.Busnello, Ph.D. Thesis, Dipartimento di Matematica, Univ.di Pisa, February 2000, & A Probabilistic approach to the 2-dimensional Navier-Stokes equations, to appear in *Annals of Probability*.
- [55] P.Baxendale and K.D.Elworthy,Flows of Stochastic Dynamical Systems, *Z. Wahrschein.verw.Gebiete* **65**, 245-267 (1983).
- [56] V.I. Arnold and B. Khesin, *Topological Methods in Hydrodynamics*, Springer Verlag, 1999.



- [57] D. Rapoport and S. Sternberg, On the interactions of spin with torsion, *Annals of Physics*, vol. **154**, no. 11, (1984), p.447-475
- [58] D. Rapoport, Random representations for viscous fluids and the magnetic fields transported on them, in *Proceedings, Year 2000 International Conference on Dynamical Systems and Differential Equations, Atlanta, May 2000*, pag. 239-247, special issue of *Journal of Discrete and Continuous Dynamical Systems*, vol. **6**, 2000.
- [59] D. Rapoport, Torsion and Quantum, thermodynamical and hydrodynamical fluctuations, in *The Eighth Marcel Grossmann Meeting in General Relativity, Gravitation and Field Theory, Proceedings*, Jerusalem, June 1997, p. 73-76, vol. A, T.Piran and R.Ruffini (eds.), World Scientific, Singapore, 1999.
- [60] D.Rapoport, Torsion, Brownian Motion, Quantum Mechanics and Fluid-dynamics, in press in *Proceedings of the Ninth Marcel Grossmann Meeting in Relativity, Gravitation and Field Theories, June 2000, Rome*, R. Ruffini et al. (eds.), World Scientific Publs., Singapore, and [www.icra.it/MG/mg9/Proceedings/Proceedings.html](http://www.icra.it/MG/mg9/Proceedings/Proceedings.html).
- [61] M. Ben Artzi, Global solutions to two-dimensional Navier-Stokes and Euler equations, *Archiv for Analysis and Rational Mechanics*, (1984), 329-358.
- [62] R. Mondolfo, *Il pensiero Antico* (1936), Spanish translation *El pensamiento antiguo*, ed. Losada, Buenos Aires, 1958; W. Jaeger, *The theology of the early Greek philosophers*, 1947.
- [63] Yu. Gliklikh, *Global Analysis in Mathematical Physics*, Applied Mathematics Sciences 122, Springer Verlag, Berlin, 1997; *Ordinary and Stochastic Differential Geometry as a Tool for Mathematical- Physics*, Kluwer, Dordrecht, 1996; Viscous Hydrodynamics through stochastic perturbations of flow of perfect fluids on groups of diffeomorphisms, *Proceedings of the Voronezh State University* (Russia), No. 1, p.83-91, 2001.
- [64] S. Shkoller, Geometry and curvature of diffeomorphisms groups with  $H^s$  metric and mean hydrodynamics, *J. of Functional Analysis* **160** (1998), 337-365.
- [65] J.Marsden & S. Shkoller, The anisotropic Lagrangian averaged Euler and Navier-Stokes equations, *Archiv Rational Mechanics and Analysis* (2001), to appear; *ibid.* Global well-posedness for the LANS equations on bounded domains, *Phil. Trans. Royal Soc. London A* (2001), to appear.
- [66] D. Rapoport, Random diffeomorphisms integration of the classical Navier-Stokes equations, *Reports on Mathematical Physics*, vol. **49**, No.1, 1-27 (2002).

- [67] D. Rapoport, Martingale problem approach to the Navier-Stokes equations on smooth manifolds with smooth boundary, *Random Operators and Stochastic Eqts.*, vol. **11**, No.2, (2003), 109-136.
- [68] C. Peskin, A random walk interpretation of the incompressible Navier-Stokes equations, *Communications in Pure and Applied Mathematics* **38**, 845-852 (1985).
- [69] D. Rapoport, W. Rodrigues, Q. de Souza, Q. and J. Vaz, J., "The Einstein-Cartan effective geometry associated to a Dirac-Hestenes spinor field", *Algebras, Groups and Geometries*, vol **14**, 27, (1994).
- [70] V.I.Arnold, Sur la géométrie différentielle des groupes de Lie de dimension infinie et ses applications a l'hydrodynamique des fluides parfaits, *Ann. Inst. Fourier* **16**, 319-361, (1966).
- [71] K.D. Elworthy, LeJan & Xue M. Li, *On the Geometry of Diffusion Operators and Stochastic Flows*, Springer Verlag Lecture Notes in Mathematics **1704**, New York/Berlin, 2000.
- [72] P. Baxendale & B.L. Rozovskii, "Kinematic Dynamo and Intermittency", *Geophys. Astrophys. Fluid Dynamics*, vol. **73**, pp.30-60, 1993.
- [73] D. Stroock and S.R.S. Varadhan, *Multidimensional Diffusion Processes*, Springer-Verlag, 1984.
- [74] R. Temam, *Infinite Dimensional Dynamical Systems in Mechanics and Physics*, Springer Verlag, New York/Berlin, 1989.
- [75] S. Pope, *Turbulence*, Cambridge Univ. Press, 2000.
- [76] L. Arnold, E.Oeljeklaus and E.Pardoux, "Almost sure and moment stability for linear Ito equations", in *Lyapunov Exponents* (eds. L. Arnold, V.Wihstutz), Lecture Notes in Mathematics **1186**, pp.129-159, Springer, Berlin, (1986).
- [77] P. Baxendale, "Stability and equilibrium properties for stochastic flows of diffeomorphisms", in *Diffusion processes and related problems in analysis*, vol. II:Stochastic flows, (eds. M. Pinsky and V.Wihstutz), *Progress in Probability***27**,3-35, Birkhauser, Boston/Basel/Berlin (1992).
- [78] P.Baxendale, "Brownian motion in the diffeomorphism group I", *Comp.Math.***53**, pp. 19-50, 1984.
- [79] P.Baxendale, "Gaussian measures on function spaces", *Amer.J.Math***98**, pp. 892-952, 1976.
- [80] P.Baxendale," Wiener processes on manifolds of maps", *Proc. Roy. Soc. Edinburgh, Sect. A***87**, pp. 127-152, 1980/81.

- [81] P. Holmes, J. Lumley and G. Berkooz, *Turbulence, Coherent Structures, Dynamical Systems and Symmetry*, Cambridge Monograph on Mechanics, Cambridge Univ. Press, Cambridge, 1996.
- [82] R. Sowers, Recent results on the short-time geometry of random heat kernels, *Math. Res.Letts.***1** 663-675 (1994).
- [83] P. Constantin and C. Foias, *Navier-Stokes Equations*, Chicago Lectures in Mathematics, 1988.
- [84] C. Doering and J.D. Gibbon, *Applied Analysis of the Navier-Stokes Equations*, Cambridge Texts in Applied Mathematics, Cambridge Univ. Press, Cambridge (U.K.), 1995
- [85] T. Taylor, On stochastic and chaotic motion, *Stochastics and Stochastic Reports***43**, pp. 179-197, (1993).
- [86] J. Wenzelburger, A kinematic model for continuous distributions of dislocations, *J. of Geometry and Physics* **24**, pp.334-352 (1998).
- [87] M.S. Narasimhan and S. Ramanan, "Existance of Universal Connections", *American Journal of Mathematics* **83**, 1961.
- [88] D. Rapoport, Realizations of the random representations of the Navier-Stokes equations by ordinary differential equations by ordinary differential equations, in *Instabilities and Nonequilibrium Structures VII & VIII*, Non-linear Phen.Complex Systems , Kluwer, 313-331, (2004).
- [89] J.M. Bismut, *Mécanique Analytique*, Lecture Notes in Mathematics **866**, (Springer, Berlin,1982).
- [90] D. Rapoport, On the geometry of the random representations for viscous fluids and a remarkable pure noise representation, *Rep. Math.Phys.***50**, no.2, 211-250 (2002).
- [91] D. Rapoport, Random representations for Navier-Stokes and their realizations by ordinary differential equations, *Random Operators and Stochastic Equations***11**, n.4, (2003), 371-401.
- [92] D. Rapoport, *Foundations of Physics***35**, no.7, 2005.
- [93] D.Rapoport, *Foundations of Physics***35**, no.8, 2005.
- [94] H. Kleinert, *Path integrals in Quantum Mechanics, Statistics and Polymer Physics*,(World Scientific, Singapore, 1991).
- [95] B.Dubrovin, A. Fomenko & S.Novikov, **Modern Geometry-Methods and Applications, vol.I**, (Springer Verlag, Berlin, 1995).

- [96] D. Rapoport, Stochastic Geometry Approach to the kinematic dynamo equation of magnetohydrodynamics, in *Trends in Partial Differential Equations of Mathematical-Physics*, J.F. Rodrigues et al (ed.), Birkhauser, Progress in Nonlinear Differential Equations Appl. 61, Boston, 2005.

# A Note on Holographic Dark Energy

Gao Shan

*Institute of Electronics, Chinese Academy of Sciences  
LongZeYuan 24-3-501, ChangPing District, Beijing 102208, P.R.China  
E-mail: [rg@mail.ie.ac.cn](mailto:rg@mail.ie.ac.cn)*

The unknown constant in the holographic dark energy model is determined in terms of a recent conjecture. We find  $d \approx \sqrt{\pi}/2$ . The result is consistent with the present cosmological observations. The holographic dark energy is re-explained by considering the quantum uncertainty and discreteness of space-time. We also predict that there may exist more dark energy between two adjacent black holes.

PACS: 98.80.Bp, 98.80.Cq

Recently one kind of holographic dark energy model is used to explain the observed dark energy [1-4]. According to the model, the dark energy density is

$$\rho_V = \frac{3d^2 c^4}{8\pi G L_H^2} \quad (1)$$

where  $c$  is the speed of light,  $G$  is the Newton gravitational constant,  $L_H$  is the size of the event horizon of our universe,  $d$  is an undetermined constant. By comparing with the observations, it was found that the holographic model is a viable one in describing dark energy [5-9]. Ref [7] obtained  $d \approx 0.85$  for the flat universe by using the supernova Ia (SN Ia) data and the shift parameter. In addition, the value of  $d$  smaller than one or the phantom-like holographic dark energy is also favored by the analysis results of the angular scale of the acoustic oscillation from the BOOMERANG and WMAP data on the cosmic microwave background (CMB) [9]. In this paper, we will theoretically determine the constant  $d$  in the holographic dark energy model in terms of a recent conjecture [10]. The holographic dark energy will be re-explained from a different point of views. We will also predict a new quantum effect of black holes.

According to a recent conjecture on the origin of dark energy [10], the dark energy may originate from the quantum fluctuations of space-time limited in our universe. By using the uncertainty principle in quantum theory, the quantum fluctuation energy of space-time of one degree of freedom limited in our universe is

$$\mathcal{E} \approx \frac{\hbar/2}{2L_H} c = \frac{\hbar c}{4L_H} \quad (2)$$

where is  $L_H$  the event horizon of our universe. Since the quantum fluctuations of space-time are essentially nonlocal, and one degree of freedom corresponds to two Planck area units in the two ends of the event horizon, the whole number of degrees of freedom of such fluctuations in our universe is

$$N = \frac{1}{2} \frac{A}{4L_p^2} = \frac{\pi L_H^2}{2L_p^2} \quad (3)$$

where  $A$  is the area of event horizon,  $L_p$  is the Planck length. Then the energy density of the quantum fluctuations of space-time in our universe is

$$\rho_\Lambda \approx \frac{N\mathcal{E}}{4\pi L_H^3 / 3} = \frac{3c^4}{32GL_H^2} \quad (4)$$

This formula results from the quantum uncertainty and discreteness of space-time. In comparison with the formula (1), we can get

$$d \approx \sqrt{\pi} / 2 \approx 0.886 \quad (5)$$

This value is in excellent agreement with the analysis result of observational data (see, for example, [7]). By inputting the current fraction value  $\Omega_\Lambda \approx 0.73$ , we can work out the equation of state:

$$w_\Lambda(z) = -\frac{1}{3} \left(1 + \frac{2}{d} \sqrt{\Omega_V}\right) \approx -0.98 + 0.25z + O(z^2) \quad (6)$$

In addition, we can also determine the current event horizon of our universe:

$$L_H \approx \frac{\sqrt{\pi}}{2\sqrt{\Omega_V}} H_0^{-1} c \approx 1.04 H_0^{-1} c \quad (7)$$

This means that the current event horizon approximately satisfies the Schwarzschild relation  $L_H = 2GM / c^2$ , where  $M = \rho_c 4\pi L_H^3 / 3$ .

It is noted that  $d < 1$  will lead to dark energy behaving as phantom, and seems to violate the second law of thermodynamics during the evolution phase when the event horizon shrinks. However, the universe inside the event horizon is not an isolated system in case of the existence of the quantum process such as the Hawking radiation. The event horizon of a black hole can shrink due to the Hawking radiation, the event horizon of our universe can also do. Thus  $d < 1$  does not violate the second law of thermodynamics when considering the whole universe system. The universe inside the event horizon and that outside the event horizon will inevitably exchange energy and information due to the quantum process. This may also explain the non-conservation of dark energy inside the event horizon of our universe.

It is generally believed that the holographic form of dark energy is obtained by setting the UV and IR cutoff to saturate the holographic bound set by formation of a black hole [1-3]. Thus the dark energy can still come from the usual vacuum zero-point energy in quantum field theory. However, a simple calculation shows that this may be not right. The lowest frequency of the vacuum zero-point energy limited in our universe is

$$E_1 = \frac{hc}{8L_H} \quad (8)$$

According to the holographic principle [13-15], the whole number of degrees of freedom in our universe is

$$N_H = \frac{A}{4L_p^2} = \frac{\pi L_H^2}{L_p^2} \quad (9)$$

Then the vacuum zero-point energy density should satisfy the following inequality:

$$\rho_{VZE} \geq N_H E_1 = \frac{3\pi c^4}{16GL_H^2} \quad (10)$$

This requires that  $d \geq \sqrt{2}\pi/2$  in the holographic form of dark energy. Since the total energy in a region of the size  $L$  should not exceed the mass of a black hole of the same size, there should exist a theoretical upper bound  $d \leq 1$ . In addition, the result  $d \geq \sqrt{2}\pi/2$  is also ruled out by the cosmological observations. This can be shown more directly from the equation of state:

$$w = -\frac{1}{3}\left(1 + \frac{2}{d}\sqrt{\Omega_V}\right) \geq -\frac{1}{3}\left(1 + \frac{2\sqrt{2}}{\pi}\sqrt{\Omega_V}\right) \quad (11)$$

By inputting the current fraction value  $\Omega_V \approx 0.73$  we obtain  $w_0 \geq -0.59$ . This has been ruled out by the observational constraint  $w_0 < -0.75$ . Thus the observed dark energy may not come from the vacuum zero-point energy in quantum field theory. The analysis also implies that the usual vacuum zero-point energy may not exist [16-18]. Even a holographic number of modes with the lowest frequency will give more vacuum zero-point energy than the observed dark energy. By comparison, the quantum fluctuations of space-time, which energy density is described by the equation (4) and is consistent with the observations, may be the origin of dark energy. Since the quantum fluctuations of space-time may be also called quantum-gravitational vacuum fluctuations, the vacuum fluctuation energy still exists. It does not come from matter, but from space-time. This may have some deep implications for a complete theory of quantum gravity.

Lastly, we will predict a new quantum effect of black holes in terms of the above analysis of dark energy. If the quantum fluctuations of space-time limited in the event horizon of our universe do exist, then it will also exist between two black holes. This means that there will exist more quantum fluctuation energy or dark energy between two black holes. Consider two black holes with the same radius  $R$ . The distance between them is  $L \gg R$ . The quantum fluctuation energy of space-time of one degree of freedom limited between them is  $\varepsilon \approx \frac{\hbar c}{2L}$ . The whole

number of degrees of freedom of such fluctuations is  $N \approx \frac{\pi R^2}{2L_p^2}$ . Then the whole quantum

fluctuation energy of space-time between the black holes is

$$E_{BHV} = N\varepsilon \approx \frac{\pi\hbar c R^2}{4L_p^2 L} = \frac{\pi R}{2L} E_{BH} \quad (12)$$

where  $E_{BH}$  is the energy of black hole. The energy density is

$$\rho_{BHV} \approx \frac{N\mathcal{E}}{\pi r^2 L} \approx \frac{\hbar c}{4L_p^2 L^2} \quad (13)$$

It is evident that the density of the quantum fluctuation energy between the black holes is much larger than that of the observed dark energy. Such energy can be detected in the local part of the universe such as the center of Milky Way. For example, the repulsive acceleration of an object

near one black hole is  $a \approx \frac{2\pi c^2}{3L^2} r$ , where  $r$  is the distance between the object and the black

hole. The repulsive force equalizes the gravitational force of the black hole when  $r \approx (RL^2)^{1/3}$ .

In conclusion, the unknown constant in the holographic dark energy model is determined in theory. We find  $d = \sqrt{\pi}/2 \approx 0.886$ . This value is perfectly consistent with the observational data. The holographic dark energy is re-explained by considering the quantum fluctuations of space-time. We also predict a new quantum effect of black holes. There may exist more quantum fluctuation energy or dark energy between two black holes.

## References

- [1] A. Cohen, D. Kaplan and A. Nelson, *Phys. Rev. Lett.* 82 (1999) 4971.
- [2] P. Horava and D. Minic, *Phys.Rev.Lett.* 85 (2000) 1610.
- [3] S. Thomas, *Phys. Rev. Lett.* 89 (2002) 081301.
- [4] M. Li, *Phys. Lett. B* 603 (2004)1
- [5] Q. G. Huang and Y. Gong, *JCAP* 0408 (2004) 006.
- [6] K. Enqvist and M. S. Sloth, *Phys. Lett.* 93, (2004) 221302; K. Enqvist, S. Hannestad and M. S. Sloth, astro-ph/0409275.
- [7] Y. G. Gong, B. Wang and Y. Z. Zhang, *hep-th/0412218*
- [8] J. Y. Shen, B. Wang, E. Abdalla and R. K. Su, *hep-th/0412227*
- [9] H. C. Kao, W. L. Lee and F. L. Lin, astro-ph/0501487
- [10] S. Gao, *Chin. Phys. Lett.* 22 (2005) 783
- [11] L. J. Garay, *Int. J. Mod. Phys A10* (1995) 145-166.
- [12] R. J. Adler and D. I. Santiago, *Mod. Phys. Lett. A* 14 (1999) 1371
- [13] J. D. Bekenstein, *Phys. Rev. D* 23 (1981) 287
- [14] G. 't Hooft, Salamfest 1993:0284-296, gr-qc/9310026
- [15] L. Susskind, *J. Math. Phys.* 36 (1995) 6377.
- [16] S. Gao, Quantum Motion and Superluminal Communication (Chinese Broadcasting & Television Publishing House, Beijing, 2000)
- [17] S. Gao, Quantum Motion: Unveiling the Mysterious Quantum World (abramis academic, London, 2006).
- [18] S. E. Rugh and H. Zinkernagel, *Studies in History and Philosophy of Modern Physics* 33 (2002) 663



# Hypergeometric universe, Quaternion Relativity and Pioneer anomaly

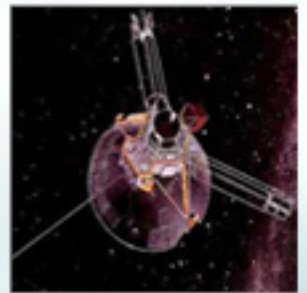
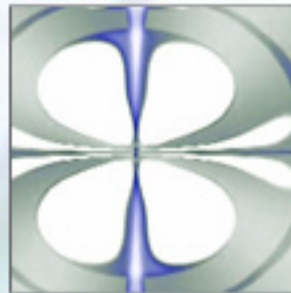
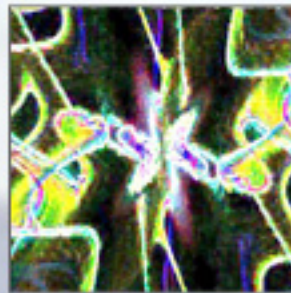
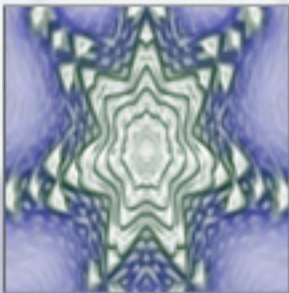
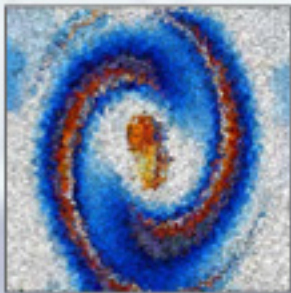

# Hypergeometrical Universe

\*Marco A. Pereira, ny2292000@yahoo.com  
Citigroup, 390 Greenwich Street, New York, NY 10013, USA

*This paper presents a simple and purely geometrical Grand Unification Theory. Quantum Gravity, Electrostatic and Magnetic interactions are shown in a unified framework. Biot-Savart Law is derived from first principles. Unification symmetry is defined for all the existing forces. A 4D Shock-Wave Hyperspherical topology is proposed for the Universe together with a Quantum Lagrangian Principle resulting in a quantized stepwise expansion for the whole Universe along a radial direction in a 4D spatial manifold. The hypergeometrical standard model for matter is presented.*

## 1 Introduction

Grand Unification Theories are the subject of intense research. Among current theories, Superstring, M-Theory, Kaluza-Klein based 5D Gauge Theories have shown diverse degrees of success. All theories try to keep the current conceptual framework of science. Kaluza-Klein melded both Electromagnetism and Einstein Gravitational equations in a 5D metric.

Here is presented a theory that departs radically from other theories and tries to bridge the conceptual gap as opposed to explore the formalism gap. Most research is concerned on how to express some view of Nature in a mathematically elegant formalism while keeping what we already know. It has been said that for a theory to be correct, it has to be beautiful.

This work concentrates on what to say, the conceptual framework of Nature instead. All the constructs of science, matter, charge, and energy are dropped in favor of just dilator positions and dilaton fields, which are metric modulators and traveling modulations, respectively. There is no concept of charges or mass. Mass is modeled a quantity proportional to the 4D displacement volume at **precise phases de Broglie cycles**. Charge sign is modeled by dilaton phase (sign) on those specific phases. This mapping is not necessary for calibration; there are no calibration parameters in this theory. The mapping is needed to show that the geometrical framework replicates current scientific knowledge.

We propose that dilators are the basic model of matter. They are coherences between two states in a rotating four-dimensional double well potential. A single coherence between two 4D-space deformation states or fundamental dilator is considered to account of all the constituents of non-exotic matter (elements, neutrons, electrons and protons and their antimatter counterparties). This coherence is between two deformation states with 4D volumes corresponding to the electron and proton, or electron-proton coherence. **Here the proton and the electron are considered to be the same particle or the fundamental dilator, just two faces of the same coin.**

The equation that describes these states is not the subject of this work. In section 2.9, a detailed description of the fundamental dilator is given, as well as the origin of the spin quantization.

Dilaton are the 5D spacetime waves, traveling metric modulations, created by the alternating (back and forth) motion of the fundamental dilator from one state of the double potential well to the other. Since these two states have different displacement volumes, spacetime waves are created. Displacement volumes are the missing (extra) volume due to spacetime contraction (dilation). Let's say that one has two points separated by a distance  $L$  in a 4D space with a dilator in the middle. The distance between those two points will change depending upon the phase of dilaton. If one considers this maximum distance change along the four dimensions for each of the two states, would be able to determine the dilator volume on each state and thus fully characterize it.

In addition to tunneling back and forth, the proton-electron dilator is considered to be tumbling (spinning) as it propagates radially (along the radial expansion direction) and that poses a constraint on the spinning frequency. Spin half particles are modeled as having a spinning frequency equal to half the electron-proton dilator tunneling frequency. Similarly higher spin particle coherences, e.g. spin  $N$ , are modeled as having a spinning frequency equal to  $N$  times the electron-proton dilator tunneling frequency.

Whenever the word dilator is mentioned within this paper, it will refer to the fundamental dilator or fundamental coherence, although there are other coherences in nature and similarly associated particle pairs.

A 3D projection of this volume corresponds to the perceived 3D mass, a familiar concept.

A logical framework is proposed on the Hypergeometrical Universe<sup>1</sup> section. This model conceptualize the 3D universe manifold as being a 3D shock wave universe traveling at the speed of light in a direction perpendicular to itself, along the radial direction.

Absolute time, absolute 4D Cartesian space manifold are proposed without loss of time and space relativism. Thus there are both preferential direction in space and preferential time, but they are both non-observables.

On the cosmological coherence section, the consequences of the topology of the hypergeometrical universe and the homogeneity proposed in the Hypergeometrical Standard Model is shown to result in a cosmological coherence, that is, the whole 3D universe expands radially at light speed and in de Broglie (Compton) steps.

When cosmological coherence is mentioned it is within the framework of absolute time and absolute 4D space.

A new Quantum Lagrangian Principle (QLP) is created to describe the interaction of dilators and dilatons. Quantum gravity, electrostatics and magnetism laws are derived subsequently as the result of simple constructive interference of five-dimensional spacetime waves<sup>2</sup> overlaid on an expanding hyperspherical universe described in section 3. In the electrostatics and magnetism derivation, a one atomic mass unit (a.m.u) electron or fat electron is used. This means that the dilatons being 5D spacetime waves driven by coherent metric modulations are sensitive to both sides of the dilator coherence.

Since 3D mass – the mass of an electron or proton from the 3D universe manifold perspective - is sensitive only to one side of the dilator coherence, the side of the dilator in phase with the 3D shock wave universe, a pseudo time-quantization is proposed in section 2.9.

Appendix A contains a brief description of the Hypergeometrical Standard Model. It shows that hyperons and the elements are modeled as longer coherences of tumbling 4D deformations. Nuclear energy is proposed to be stored on sub-coherence local twisting of the fabric of space. A more detailed description of the model will be presented elsewhere.

A grand unification theory is a far-reaching theory and touches many areas of knowledge. Arguments supporting this kind of theory have by definition to be equally scattered. Many arguments will be presented with little discussion when they are immediate conclusions of the topology or simple logic.

## 2 Hyperspherical Universe

### 2.1 Quantum Lagrangian Principle

A new Quantum Lagrangian Principle (QLP) is defined in terms of dilator and dilaton fields. It proposes that the dilator is always in phase with the surrounding dilatons at multiples of  $2\pi$  wavelength. This simply means that a dilator, trying to change the metric in a specific region of 4D space, will always do that in phase with all the other dilatons. The fundamental dilaton wavelength will be called de Broglie wavelength and will be shown in the section 2.9 to correspond to the Compton wavelength, since motion along the radial direction is at lightspeed, of a one atomic mass unit particle.

### 2.2 Topology

The picture shown in Figure 1 represents a cross section of the hyperspherical light speed expanding universe. The universe is considered to be created by an explosion, but not by a three-dimensional explosion. Instead, it is considered the result of a four-dimensional explosion. The evolution of a three-dimensional explosion is an expanding two-dimensional surface. **The evolution of a four-dimensional explosion is an expanding three-dimensional hypersurface on quantized de Broglie steps. The steps have length equal to the Compton wavelength associated with the fundamental dilator (one atomic mass unit).** All times are made dimensional by the multiplication by the speed of light.

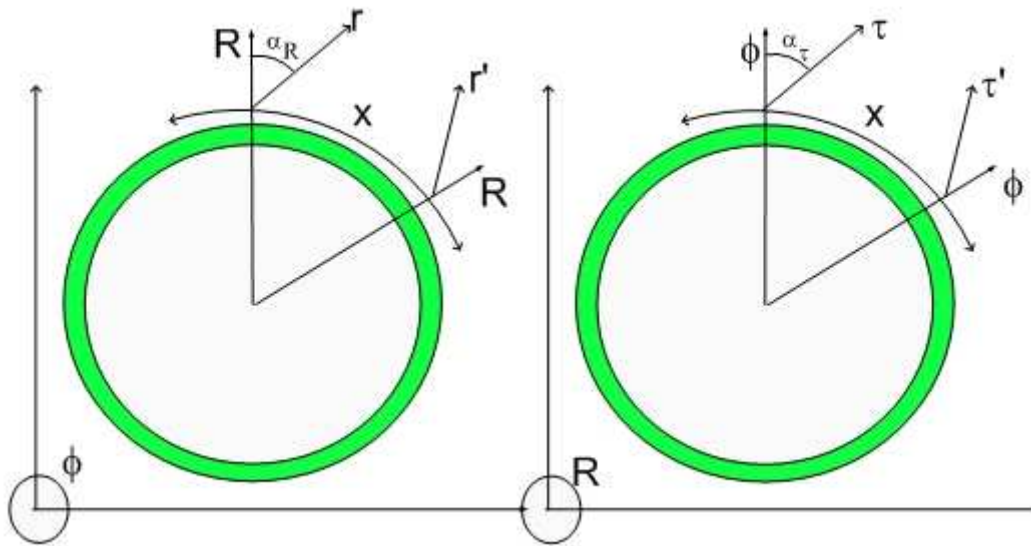

Figure 1. Shows the cross-section  $X\tau$  and  $XR$  for the expanding universe. The universe length along  $X$  is represented by the band.  $X$  (or  $Y$  or  $Z$ ) is displayed along the perimeter of the circle. Also shown in the diagram is  $\Phi$  (cosmological time) and radial time projection  $R$ .

Definitions:

- Cosmological time  $\Phi$  represents an absolute time frame, as envisioned by Newton and Mach - it is a fifth dimension in the hypergeometrical universe model.

- The radial direction is a preferential direction in 4D space. It is the radial expansion direction. This direction doubles as a direction on 4D Space and a projection of the cosmological time. Since they are related by the expansion speed (light speed), one can think about the radial direction as the radial time – an absolute time projection.
- Similarly,  $\tau$  is any other propagation direction and also a projection of proper time, here called dimensional time. For small velocities with respect to the fabric of space (see description below), the dimensional time approximately matches the 4D direction of propagation ( $\arctan(v/c) \sim \operatorname{arctanh}(v/c) \sim v/c$ ). This maps our local frame proper time to a 4D direction of propagation and it is the source of the relativism in the theory of relativity. Different angles of propagation reflect different relative velocities. Notice that although this argument made use of a preferential 4D direction, it could be done using any possible referential frame. Within the 3D space, one can only observe the relative angle and relative velocity.
- This mapping done because of the consideration that a Lorentz transformation can be thought as a rotation around the directions perpendicular to proper time and velocity by an imaginary angle of  $\operatorname{arctanh}(v/c)$ . On a 4D spacetime, when one considers a proper frame of reference, one only travels in time. The addition of a fourth spatial dimension means also that when one is in one's proper 3D frame of reference one is also propagating along either the directions  $R/\Phi$  or  $r/\tau$ .
- $R$  keeps a simple relationship with the dimensionalized cosmological time  $\Phi$  (identical module relationship).
- The fabric of space (FS) is just the region of 4D space – a traveling boundary- where the 3D hypersurface (shock wave universe) stands at any given time. It is different from the rest of the 4D space because it contains imprinted in local deformations, all particles in the universe.
- Fabric of space is used in two manners: a) as the locally non-twisted 4D space – pointing to this traveling boundary-, where local proper time projection  $\tau$  and direction of 4D propagation points in the radial direction  $\Phi/R$  and b) the subject of deformation.
- Under these conditions one can define a referential frame that is standing still with respect to the FS while traveling at the speed of light outwards radially. This is a preferred referential frame. Two preferred referential frames far apart in 3D space will recede from each other at the Hubble's speed (see section 2.5).
- After the shock wave universe passes through, the 4D space returns to its relaxed condition.
- There are two kinds of deformations in 4D space: compression and torsion. The compression is what happens in dilators or particles. They represent coherence between two compression deformation states.
- Torsional states are related to absolute state of motion of neutral matter and are defined by the local tilt of the perpendicular to the FS region inhabited by it. The FS can be under torsional forces in the region near dilators. The region where a dilator exists will persist under stress (tilted) as the dilator moves towards a region where that stress can be relaxed.
- Far from matter, there should be only residual torsional deformation due to the evanescent dilators. On the other hand, the region of space where a “zero spin particle” or neutral matter exists, the local environment is permanently deformed through

interactions with other bodies' dilatons. Deformation will last until the all the interacting bodies reach regions where their relative velocity matches the Hubble velocity of that part of the Fabric of Space.

- The angle between R ( $\Phi$ ) and r ( $\tau$ ) defines the local FS deformation.
- The angle between  $\tau'$  ( $r'$ ) and  $\tau$  ( $r$ ) defines the relative degree of local FS deformation.
- “Volumetric” and “superficial” dilatons are 5D and 4D spacetime waves define in analogy to volumetric and superficial sound waves. Instead of having pressure or density modulations as in sound waves, one has metric (or 4D space) modulations.
- Since the hypersurface is our three-dimensional universe, a “superficial” dilaton is a spacetime disturbance that propagates along the FS. Associated zero spin dilatons will propagate always in perpendicular to the FS, although they might move sidewise between de Broglie expansion steps.
- A “volumetric” spacetime dilaton is free to redirect its k-vector on any direction. Associated non-zero spin dilatons will be able to freely change their propagation direction in addition to the sidewise motions at each de Broglie expansion step.
- Dilatons and dilators are used interchangeably in certain situations since the QLP requires the dilatons to always be in phase (surf) the surrounding dilaton field.

Figure 1 displays one time dimension ( $\Phi$ ) and three time projections (R,  $\tau$  and  $\tau'$ ). Each reference frame has its own proper time projection. This figure also shows that the four-dimensional spacetime is curved, being the radius of curvature given by the dimensional age of the universe. This simple figure eliminates the need for cosmological constant questions, considerations about gravitational collapse or anti-gravitational acceleration of the expansion of the three-dimensional universe, since the universe is proposed to be four-dimensional plus a cosmological time  $\Phi$ . In this model, the shock wave hyperspherical universe is clearly finite, circular (radius of curvature equal to the dimensional age of the universe, that is, the speed of light times the age of the universe). It is also impossible to traverse, since it is expanding at the speed of light. **The Cosmic Microwave Background is assigned to a Doppler shifted view of the initial Gamma Radiation Burst<sup>3</sup>.**

### 2.3 Origins of the Hyperspherical Expansion

The clues for the creation of this models lies on relativity and quantum mechanics. Relativity states that the energy of a particle with rest mass  $m_0$  and momentum p is given by:

$$E = mc^2 = c\sqrt{p^2 + m_0^2 c^2} \quad (2.1)$$

where m is the mass in motion. This equation has implicit assumptions which can be brought into light by considering it a momentum conservation equation instead:

$$P^2 = (mc)^2 = p^2 + m_0^2 c^2 \quad (2.2)$$

Where P is the four-momentum of the particle in motion (at the speed of light) traveling such that its  $\tau_{\text{particle}}$  makes angle  $\alpha$  with the static reference frame  $\tau_{\text{observer}}$ . Implicit in equation (2.2) is that the particle is actually traveling along a four-dimensional space (timed by a fifth time dimension) and has two linear momentum components:

- a) Three-dimensional momentum p

b) Perpendicular momentum  $m_0c$  in the direction of radial time.

In addition, the particle travels at the speed of light in along a hypotenuse with an inertial mass  $m$ . Now it starts to become clear that the motion of the particle is actually in a five dimensional space (four physical dimensions and a time) and at the speed of light, being the three dimension motion just a drift. The trigonometric functions associated with a relativistic Lorentz transformation are given in terms of velocity by:

$$\cosh(\alpha) = \frac{1}{\sqrt{1 - \frac{v^2}{c^2}}} \quad (2.3)$$

$$\sinh(\alpha) = \frac{\frac{v}{c}}{\sqrt{1 - \frac{v^2}{c^2}}} \quad (2.4)$$

$$\tanh(\alpha) = \beta = \frac{v}{c} \quad (2.5)$$

Manipulating equation (2.2) and using  $m = m_0 \cosh(\alpha)$  one obtains:

$$(mc)^2 = (mv)^2 + m_0^2 c^2 \quad (2.6)$$

$$(m_0 \cosh(\alpha) c)^2 = (m_0 v \cosh(\alpha))^2 + m_0^2 c^2 \quad (2.7)$$

$$(m_0 \cosh(\alpha) c)^2 = (m_0 \sinh(\alpha) c)^2 + m_0^2 c^2 \quad (2.8)$$

$$\left(\frac{1}{\lambda_\tau}\right)^2 = \left(\frac{1}{\lambda_{xPrime}}\right)^2 - \left(\frac{1}{\lambda_{\tauPrime}}\right)^2 \quad (2.9)$$

With

$\frac{1}{\lambda_\tau} = \frac{m_0 c}{h}$  de Broglie wavelength for the particle on its own reference frame, traveling at the speed of light in the proper time projection  $\tau$  direction.

Projection on the  $\tau$ prime direction.

$$\frac{1}{\lambda_{\tauPrime}} = \frac{1}{\lambda_\tau} \cosh(\alpha)$$

Projection on the  $x$ prime direction.

$$\frac{1}{\lambda_{xPrime}} = \frac{1}{\lambda_\tau} \sinh(\alpha)$$

Equation (2.9) is the basic equation for the quantization of relativity. It describes the motion of a particle as the interaction of two waves along proper time projection and three-dimensional space. The  $\lambda_{\tauPrime}$ , that is, the projection on the  $\tau'$  axis of the wave propagating along the  $\tau$  axis (resting reference frame) is given by:

$$\frac{\lambda_\tau}{\lambda_{\tauPrime}} = \cosh(\alpha) \quad (2.10)$$

$$\frac{\lambda_\tau}{\lambda_{xPrime}} = \sinh(\alpha) \tag{2.11}$$

This means that the projected de Broglie time-traveling wavelength is zero when the relative velocity reaches the speed of light. Zero wavelengths means infinite energy is required to twist spacetime further. The rate of spacetime twisting with respect to proper time relates to the power needed to accelerate the particle to a given speed. From equation (2.5), acceleration in the moving reference frame can be calculated to be:

$$Acceleration_{Prime} = c^2 \frac{d \tanh(\alpha)}{d\tau_{Prime}} \tag{2.12}$$

In the particle reference frame the acceleration has to be given by Newton's second law

$$Force = M_0 Acceleration_{Prime} = M_0 c^2 \frac{d \tanh(\alpha)}{d\tau_{Prime}} \tag{2.13}$$

This means that any force locally twists spacetime, and not only gravitation as it is considered in general relativity. It also shows that as the relative speed between the two reference frames increases towards the speed of light, the required force to accelerate the particle approaches infinite. The same reasoning can be done for the concomitant rotation perpendicular to RX, resulting in the replacing the minus sign by a plus sign on equation (2.9) and the recasting equations (2.10) and (2.11) in terms of trigonometric functions as opposed to hyperbolic functions. Rotations around  $\tau X$  or  $RX$  result in a real angle  $\alpha = \arctan(v/c)$ .

Figure 2 below displays the particle as a de Broglie wave oscillating as a function of cosmological time  $\Phi$ , propagating along R. This is a proper reference frame plot, that is, the particle is at rest at the origin with respect to the fabric of space and only travels along the radial time direction R.

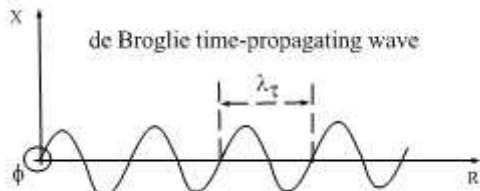

Figure 2. This model shows a de Broglie oscillation as a function of Cosmological Time  $\Phi$  using the proxy of time R.

The diagram below represents the same observation from a moving frame of reference (relative velocity  $c$  times  $\tan(\alpha)$ ):



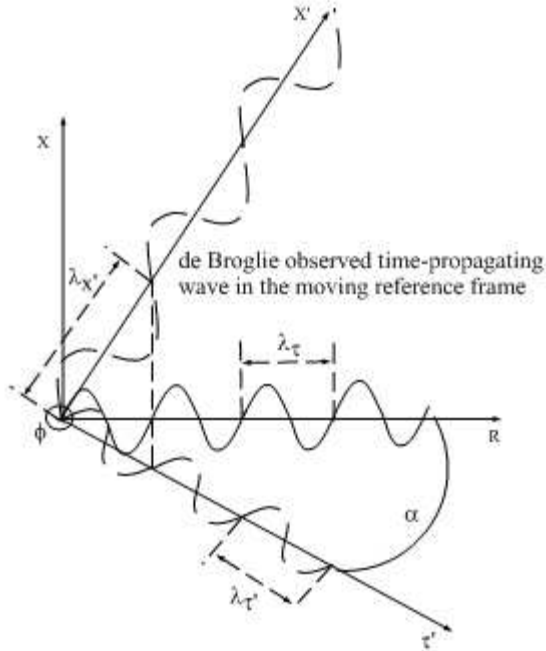

Figure 3. Projection of de Broglie Wave in the moving frame of reference.

### Energy Conservation of de Broglie Waves:

The total kinetic energy, calculated in terms of de Broglie momenta, is equal to the Relativistic Total Energy value of a free particle. The total energy is  $M_0c^2$  in the proper reference frame and equal to:

$$E = \frac{1}{M_0} \left[ \left( \frac{h}{\lambda_{xPrime}} \right)^2 - \left( \frac{h}{\lambda_{tPrime}} \right)^2 \right] = \frac{h^2}{M_0} \left[ \left( \frac{\cosh(\alpha)}{\lambda_t} \right)^2 - \left( \frac{\sinh(\alpha)}{\lambda_t} \right)^2 \right] = \frac{h^2}{M_0 \lambda^2 \tau} = M_0 c^2 \quad (2.14)$$

in the moving referential frame.

### Phase Matched de Broglie Wave Interpretation of a Particle

Let consider a particle as a de Broglie wave. In its own referential, it just propagates in the direction of radial time R, as in figure 2. On a moving reference frame, shown in figure 3, the de Broglie wave is decomposed in two:

- One with wavelength  $\frac{1}{\lambda_{xPrime}} = \frac{\cosh(\alpha)}{\lambda_t}$  propagating along x
- A second with wavelength  $\frac{1}{\lambda_{tPrime}} = \frac{\sinh(\alpha)}{\lambda_t}$  propagating along  $\tau$ .

Their nonlinear interaction results in:

$$\psi_1(x, \tau) = \cos\left(\frac{2\pi}{\lambda_e} x \cosh(\alpha)\right) \cosh\left(\frac{2\pi}{\lambda_e} \tau \sinh(\alpha)\right) \quad (2.15)$$

$$\psi_1(x, \tau) = \frac{1}{2} \cosh\left(\frac{2\pi}{\lambda_e}(x \cosh(\alpha) - \tau \sinh(\alpha))\right) + \frac{1}{2} \cos\left(\frac{2\pi}{\lambda_e}(x \cosh(\alpha) + \tau \sinh(\alpha))\right) \quad (2.16)$$

or two waves propagating in the direction of  $\alpha$  and  $-\alpha$  with wavelength equal to  $\frac{\lambda_e}{\cosh(\alpha)}$ . Thus

a particle can be described as a phase matched wave propagating along its dimensional time direction as the hyperspherical universe expands as a function of cosmological time.

## 2.4 The Meaning of Inertia

From equation (2.12) it is clear that inertia is a measure of the spring constant of spacetime, that is, how difficult it is to twist spacetime. Any change in the state of motion also changes the direction as referred to the absolute referential frame  $R\Phi$ , which means that inertia is also a measure of how difficult it is to locally twist the fabric of space.

Notice that Newton's first equation (equation 2.13) can be recast as an equation stating that the strain on the fabric of space is the same on both projections shown in figure 1.

$$\frac{d \tanh(\alpha_\tau)}{d\tau} = \frac{d \tan(\alpha_R)}{dr} \quad \text{since} \quad \tanh(\alpha_\tau) = \tan(\alpha_R) = \frac{v}{c} \quad \text{and} \quad r \quad \text{and} \quad \tau \quad \text{are} \quad \text{numerically} \quad \text{identical.}$$

To obtain the force (stress) needed to create such a strain, one needs to multiply the strain by the area subject to it. In the 4D hyperspherical paradigm, this means that the mass is proportional to the 3D projection of the 4D displacement volume associated with the objects (particles).

This identity is used thoroughly during the grand unification calculations on section 3.

## 2.5 Why do things move?

The relaxation of a fabric of space deformation is considered within this theory to be the cause of inertial motion. Two objects would act upon each other and then distance themselves until their interaction is vanishingly small. Under those conditions their distance would grow until they reach their Hubble equilibrium position, that is:

$$v = C_{Hubble} * L_{HubbleEquilibrium} \quad (2.17)$$

$$L_{HubbleEquilibrium} = \frac{v * 4DRadiusOfTheUniverse}{c} \quad (2.18)$$

Where it is clear that the Hubble constant is given by:

$$C_{Hubble} = \frac{c}{4DRadiusOfTheUniverse} \quad (2.19)$$

The 4D radius of the universe is shown in Figure 1, and it is equal to the age of the universe times  $c$ . At that point, 4D space would be relaxed and their distance would grow governed by the universe expansion. Even though matter would be standing still with respect to the FS, their relative motion would continue at the Hubble speed forever. The fraction of the universe that is relaxed at any given time and direction can be measured from the distribution of Hubble constants. The narrower the distribution of Hubble constants from a given region of the Universe, the more relaxed that region is. **Needless to say, this is the underlying reason for Newton's first law.** The proposed topology implies that the Big Bang occurred on all points of the shock wave universe (or the currently known 3D Universe) at the same time. Since matter is considered to have rushed away from each and every point of the 3D universe in a spherically

symmetric manner, the Hubble constant has to be a constant for the average. Other cosmological implications will be discussed in a companion paper.

Equation (2.16) might seem obvious but it is not. There are questions about why the Hubble constant is not constant. In this theory it is clear that the Hubble constant relates to the average velocity in a given region of space and thus it should not be a constant applicable to each and every observation.

## 2.6 Why is the Speed of Light the Limiting Speed

In this model, in a de Broglie universe expansion step, the furthest a dilator can move is one de Broglie wavelength sidewise, that is, along the spatial direction (see Figure 1). That would result in a 45 degrees angle with respect with  $R$ .

The proposition of this theory is that this is the real reason for Lorentz transformations asymptotic behavior and that inertia is really a measure of the difficulty to bend local 4D space. In section 2.3 it became clear that they are the same rotation, driven by the change in velocity.

From Hubble considerations and from examining Figure 1, it is clear that the maximum absolute speed is  $\pi*c$ , but cannot be measured because one can never see or reach anything beyond one radian in the shock wave universe.

## 2.7 Hypergeometrical Standard Model

A new model for matter is proposed. In this initial model, the elements, protons, electrons and neutrons and their antimatter counterparties are recast as being derived from a single particle. This particle is expressed in geometrical terms as being a coherence between two 4D deformation stationary states from a rotating 4D double potential well. This coherence is called a dilator. As the dilator oscillates between sides of the potential well, it creates a traveling modulation of the metric or 5D spacetime waves or dilatons. Spin is modeled not as an intrinsic degree of freedom, but as an extrinsic tumbling or rotation of the dilator. **Since the dilaton frequency is defined just by the gap between the fundamental dilator states, its frequency does not depend upon the mass of the dilator.** Dilatons travel through the 4D space. 3D projections are known as de Broglie matter waves. This is an important concept since a corollary is that a monochromatic (same velocity) flow of electrons will produce a coherence dilaton field, superimposed on the dilaton random black body background. This will be used to explain the double slit experiment in the Conclusions section. Planck's constant is the connection between the 3D dilaton projection wavelength and the particle 3D linear momentum. **Planck's constant ensures that for the 3D observed mass and velocity, the de Broglie wavelength will match its fundamental dilaton 3D projection.** Mass is considered to be proportional to dilator maximum 4D volume. Calibration is made to replicate Gauss' electrostatics law, Newton's gravitational law and Biot-Savart law of magnetism. Since mass is proportional to a 4D volume and volume depends upon lengths, which are Lorentz invariant, the 4D-mass volume representation is also Lorentz invariant. 4D-mass is defined as being the total mass or 4D volume displaced in an oscillation cycle. Since the dilator oscillates between states corresponding to an electron and a proton, its 4D mass will be one atomic mass unit. 3D-mass is the mass or 4D displacement volume perceived in the 3D Space at given phases of the de Broglie expansion.

Dilators with spin zero are modeled to couple with superficial wave, and thus their position changes from one de Broglie cycle to the next just by the displacement governed by a new quantum Lagrangian principle. Its propagation direction continues to be perpendicular to the 3D universe hypersurface. Dilators with non-zero spin are modeled to couple with volumetric wave, and their position changes from one de Broglie cycle to the next just by the displacement governed by the Lagrangian principle. In addition, its propagation direction is redirected by the

angle covered by this transition. Since the change in angle is defined with respect to the last step k-vector, charged particles are to sense a much higher acceleration than zero spin particles (matter). **This is the proposed reason behind the strength difference between gravitation and electromagnetic Forces.**

## 2.8 Cosmological Coherence

The coordinated actions of dilators implicit in the proposed Lagrangian principle mean that even though the dilator is a 5D spacetime wave generator it behaves as a wave, thus implicitly replicating wave behavior. Its position is determined at each de Broglie step according to the local dilaton environment.

The concept of 4D spacetime deformation coherences generating waves is created in analogy with electromagnetic waves being created by electronic coherences. In the case of spacetime coherences, the coherences for the fundamental dilator (proton-electron dilator) are never dephased. Dephasing would result in proton or electron decay or disappearance. The states corresponding to the proton and to the electron are considered to be the ground states for each one of the two wells, thus they cannot decay further, only dephase.

All matter in gravitational and electromagnetism studies here modeled are composed of protons, electrons and neutrons, thus are composed of this fundamental dilator. Although current understanding of charged particles associates with them a gravitational mass, their gravitational field could never be measured. If it were to exist, their electric field would be  $10^{36}$  times larger than their gravitational field.

In this model, charged particles have no gravitational field, since in this model there is only one kind of interaction and two kinds of responses.

The Quantum Lagrangian Principle means that all matter, charged or not, is synchronized with the surrounding dilatons, thus generating a cosmological coherence.

This idea of a cosmological or macroscopic coherence might seem unexpected but it is built-in in the concept of field. Fields are constructs derived from electromagnetism and gravitation equations. In a purely geometrical theory, which has been the goal of many scientists and philosophers for thousands of years, there should be only a few constructs: space, space wave (metric modulations), and local and global symmetry rules (angular and linear momentum conservation) adapted to the appropriate constructs. There shouldn't be mass or charge in a purely geometrical theory, only displacement volume and phase. Returning to the concept of fields, when one consider gravitation/electrostatics to be an extensive properties of mass/charge, one is implicitly adding the corresponding wave amplitudes within an implicit geometrical theory without regard to their phases, that is, fields imply coherences. This is a fine point that has been missed since nobody planned to eliminate the concept of mass and charge to build a geometrical theory. Einstein's gravitation theory used mass to deform spacetime. Kaluza-Klein also used mass to deform spacetime and created a compact dimension to store the electromagnetic fields. In this theory, coherent dilatons controls dilators motions in a mutually consistent cosmic symphony.

Figure 3 displays two inertial systems with the same origin. System with distinct origins would have an additional phase-shift due to the retarded potential interaction. This is the reason why all the waves in a multi-particle body can have their amplitudes added together, as opposed to having their amplitudes averaged out to zero due to a random phase relationship. It shows that a particle state of motion does not modify its phase relationship with the expanding hypersurface (3D Universe). The particle is always phase matched to the rest of the universe. This is the meaning of physical existence. Our concept of existence is based on interaction. If a particle had a de

Broglie wavelength different from the one of the fundamental dilator, its interaction would average out to nothing. No interaction means no material existence. A neutrino is an almost perfect example of this pattern – it still interacts a little. The phase matching condition implies that the entire universe is in phase (lived the same number of de Broglie cycles) as it propagates along the radial direction R. This also means that the universe is thin along the radial direction of propagation (much less than one de Broglie wavelength thin).

**The number of de Broglie cycles a particle passes through is independent upon the angle  $\alpha$  (relative velocity). This means that any dilator of a given type is always in phase with another of the same type, irrespectively of its trajectory through the universe. It also means that protons, electrons, neutrons created in the dawn of the universe kept the same phase relationship with all the other protons, electrons and neutron of the universe throughout the ages. The same is true for any particle created at any time. De Broglie wavelength, phase and intensity are properties shared by particle classes.**

This coherence is essential in creating a quantum gravity theory and it is essential to the hypergeometrical theory. In fact, cosmological coherence is a hypothesis and a corollary of the hypergeometrical theory, because one could not construct a geometrical theory without a cosmological coherence due to the extensive property of gravitational, electrostatic and magnetic fields.

## 2.9 Quantization of Time and the Fat Electron

The theory makes use of a fat electron, that is, a one atomic mass unit electron in the derivations on sections 3.1 and 3.2.

The derivations are done in the 5D spacetime and yield the acceleration for a single particle subject to one kilogram mass or to one kilogram of charge. Notice that acceleration is not force. To obtain a force, which is a 3D concept, one has to multiply by a 3D mass. To understand why one would use a one atomic mass unit electron, and what are the 3D and 4D masses, one has to see the process in 4D. First one needs to understand neutron decay to have some representation of the electron and proton 4-D deformational states.

The hypergeometrical standard model for the neutron decay process is shown next:



Where the 4D deformation states are given:

$$(2/3, -1/3, -1/3) \rightarrow (2/3, 2/3, -1/3) + (0, -2/3, -1/3) + (0, -1/3, 1/3) \quad (2.20)$$

respectively.

Conversely:

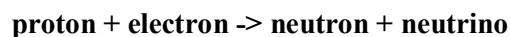

$$(2/3, 2/3, -1/3) + (0, -2/3, -1/3) \rightarrow (2/3, -1/3, -1/3) + (0, 1/3, -1/3) \quad (2.21)$$

The representation of the neutron decay is presented here just to showcase how one thinks about nuclear chemistry in the hypergeometrical universe framework. The “quark” numbers are not meant to be considered the quark composition of the particles. It is an equation of 4D volume conservation and the numbers represent the three axis lengths of a 4D ellipsoid of revolution. Negative numbers just means that they have opposing phases. The total 4D volume of all particles in the universe should add up to zero. Any particle can be described through these types of equations and that will be discussed elsewhere. Notice that no number was given to the fourth dimension. There is no mentioning of the residual length of the fourth coordinate for simplicity,

but it is certainly smaller than the others, thus the resulting skinny profile when the dilator is rotated by 90 degrees. This assignment was done considering the lowest 4D volumes or lowest numbers, the number **ONE** can be decomposed for representing the nuclear reaction (neutron decay).

This is clearly unorthodox, since the electron is not supposed to have a quark composition.

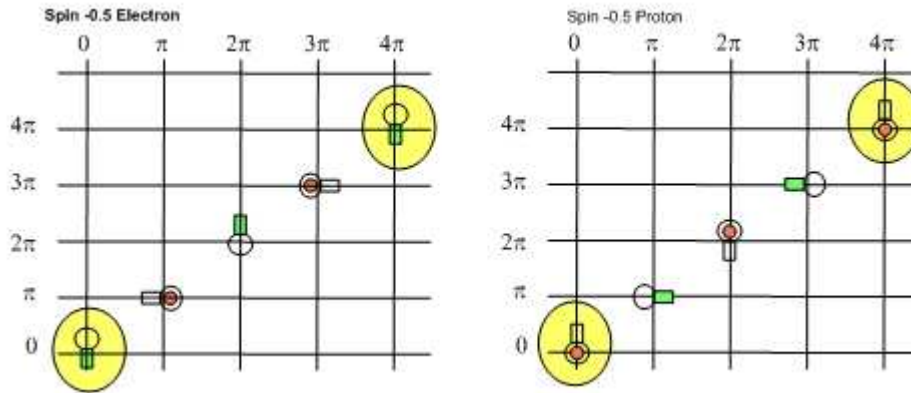

Figure 4. The figure above show an electron-proton dilator as it tumbles during two de Broglie wavelength universe expansion, with the two possible initial phases. The left (right) scheme corresponds to an electron (proton).

The red dot indicates that the coherence is on the proton side ( $2/3, 2/3, -1/3$ ), while the green rectangle indicates that the coherence is on the electron side ( $0, -2/3, -1/3$ ). Spin has been modeled as an extrinsic rotation perpendicular to RX. Spin half (N) means that the dilator performs half (N) rotational cycle for each de Broglie expansion step. Notice that the representation of spin as a 4D rotation is distinct from orbital momentum L and total Momentum J. This is a four-dimensional space theory and one has to have angular momentum conservation in four dimensions, thus the rules for total angular momentum conservation are valid.

Orbital momentum L and total angular momentum J are 3D concepts and will result from the projection of the equations of motion solution on the 3D hypersurface. Quantum mechanics replication is outside the scope of this paper. The behavior required by the quantum Lagrangian principle has the similar traits to the Bohr model. If one considers that in the prescribed QLP 4D trajectories, the electron riding the 4D dilaton wave will also ride its 3D projection -the corresponding de Broglie matter wave- then it becomes clear that QLP will immediately reproduce the Bohr hydrogen model and more.

### 2.9.1 3D and 4D Masses

Now one can define the 3D and 4D masses. From Figure 4, it is clear that what distinguishes an electron from a proton is a rotational (spin) phase. This means that our 3D interactions (material existence) support a pseudo time-quantization or intermittent interaction on quantized time steps. Thus 3D masses are the masses one observes at de Broglie expansion phases  $0, 2\pi, 4\pi, \dots$ . It is worthwhile to notice that on the de Broglie expansion phases  $\pi, 3\pi, 5\pi, \dots$  (when the dilator character changed totally and the 4D volume reaches a maximum) the 3D projection is minimal. In the case of an electron, the de Broglie expansion phase  $\pi$  corresponds to a skinny or laying down proton (nothing to grab). In this work, we are not presenting the equations of motion of the 4D tunneling rotor, since they are not necessary for the understanding of the physical model. They are not needed either for the proposed grand unification theory. One only needs to know that 4D volumes are associated with electrons and protons and that electrons and protons are the two sides of the tunneling system. One also has to keep in mind that the 3D projection of this 4D volume is proportional to the corresponding 3D mass or simply particle mass. The derivation of

3D volumes from 4D volumes is done through simple local Cartesian projections, thus are trivial. The detailed shape of these states also doesn't matter for this discussion. One only needs to know that the thickness (radial dimension thickness) of these states is much smaller than the de Broglie (Compton) wavelength of the dilator (one a.m.u. particle) to understand that when the tunneling rotor (dilator) is rotated by 90 degrees, it should show a much smaller volume from the perspective of the 3D universe.

### What would be the meaning of a 4D Mass?

Remember that in a geometrical theory, mass has to be related to a 4D displacement volume. From the point of view of four-dimensional waves being generated by coherently located dilators, it doesn't matter if the proton or electron are standing up or laying down, the 4D volume is the same. This means that the 4D mass of an electron is equal to the 4D mass of a proton - approximately one atomic mass unit. One atomic mass unit corresponds to a standing-up proton and a standing-up electron which is the exactly the mass of a hydrogen atom. This is an approximation because of the relativistic shrinking of volume as a function of relative motion. The correction factor should be, in terms of 4D volumes, equal to (standing-up electron + laying-down proton)/(standing-up electron + standing-up proton). In other words, a standing-up electron (proton) has a different perceived 4D volume than a laying-down electron (proton). This correction factor should be related to the electron gyromagnetic ratio. From there, one should be able to derive an instantaneous tangential speed. For sake of completeness, I will present briefly the other relevant particles:

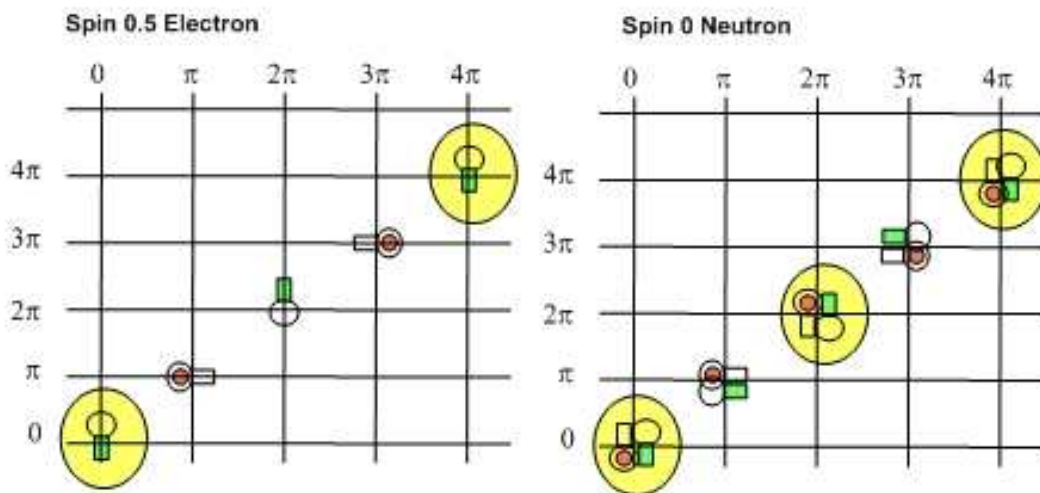

Figure 5. The left (right) scheme corresponds to a spin-plus half electron (spin-zero neutron).

A zero spin neutron is just a combination of the two dilator rotational states such that the total angular momentum and charge is zero. Its physical meaning is a transition state in the nuclear chemistry reaction described in equation (2.21). It is also, the closest representation to the archetypical gravitational particle. In this theory, electrons and protons join to form neutral matter. Neutral, zero spin matter is the matter that shows only gravitation. Figure 5 shows how the rotating dilator would interact to create this state. It is shown to showcase reasoning behind Hund's law. Hund's law states that particles should form pairs of zero spin, that is, one electron of spin +0.5 joins another with spin -0.5 in and electronic orbital. This is supposed to have a lower energy than if you put each electron by itself in each orbital. Figure 6 shows a spin -0.5

neutron, the only one observed in nature. It seems that the neutron as a whole is rotating, but this corresponds to a combination of a spin  $+0.5$  proton with a spin  $+0.5$  electron. Since this combination is the only one observed in nature, it should mean that it has higher energy or higher 4D volume. Remember that one is considering the reaction in reverse, that is, one is considering adding one electron to a proton to yield a neutron and a neutrino- an endothermic reaction.

The difference in energy or conversely 4D volume is the emitted neutrino described in equation (2.21). The neutrino also carries the extra angular momentum.

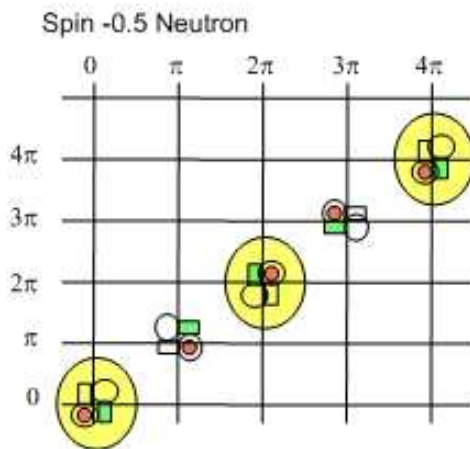

Figure 6. The figure above shows an electron-proton dilator dimmer (neutron) as it tumbles during a two-de-Broglie-wavelength universe expansion. The scheme corresponds to spin-minus half neutron.

If one adds a Spin  $-0.5$  proton to a Spin  $+0.5$  electron you get a Spin  $0$  neutron, which subsequently decays and emits a neutrino. The neutrino corresponds to the transition from spin-zero to a spin-half neutron. Since one would expect that the change in volume between the two states to be minimal, the neutrino is expected to have a lower tunneling frequency and thus being non-interacting, in fact, very little interaction, massless, chargeless and thus immaterial.

Normally, one only speaks of spin projections along the 3D space directions. Since one has a physical model of a tumbling 4D dilator in a 4D space one has to define a direction of motion. Negative and positive spins are assigned to clockwise and counterclockwise rotations to keep angular momentum conservation in the 4D space. Antiparticles differ from their counterparts just by a 180 degrees dilation phase shift. Other nuclear chemistry reactions should have similar representation being the only difference the dilator coherence.

## 2.10 The Meaning of a Charge

From section 2.9 it becomes obvious what is the meaning of a charge. It is only the in-phase sign of the dilation. A proton is positive because it is dilated as a proton – it has proton 3D mass or proton 4D Volume, when observed by the shock wave universe. An anti-proton would have the same 3D mass but the 4D displacement volume would be negative, that is, the modulation in metric had the opposite effect on 4D Space. The difference in 4D Volume on specific phases is why a proton and an electron do not annihilate each other, as do a proton and an anti-proton.

## 3 Force Unification

### 3.1 Quantum Gravity and Electrostatic Interaction

Let's consider a body and a particle interacting through their four-dimensional waves. The body will always have a kilogram (of mass or charge) and the particle will always be a one a.m.u. (atomic mass unit) particle (~neutron). For the gravitational interaction, this particle will have zero spin, while it will have spin half for the electrostatic interaction. Although the four-dimensional wave interaction is taking place on the hypersurface of a four-dimensional expanding hypersphere, one will make use of cross-sections to calculate interference patterns. Interference is considered on each de Broglie expansion of the hyperspherical universe. Notice that spacetime waves and their sources will be described in detail in a paper of this series. One can briefly describe the source of waving as a four-dimensional particle (four-dimensional ellipsoid of



revolution or particle X for simplicity). The X particles are characterized by four axes lengths. Three axes lengths correlate with the quarks composition of matter. The fourth-axis always points in the radial time direction. Needless to say, different quarks (axis lengths) and different rotational states around the four axis will be sufficient to map all known particles (photons, mesons, neutrinos, etc). Volume (mass) tunnels in an out of the three-dimensional space for spinning particles (particles with non-zero spin) and out and in towards the radial time dimension. Spin is considered to be a special rotation, since the rotation axis is perpendicular to radial time and one of the spatial coordinates. That gives spinning a different effect; it brings the particles in and out of the fabric of space, thus allowing for a realignment of the k-vector of associated spacetime waves. Let's consider the interaction through a two-dimensional cross-section ( $X \times T$ ). Particle one (one a.m.u "zero spin neutron" or fat electron) sits on  $x=0$ , while particle two (the body of 1 Kg) sits on  $x=R_0$ . The four-dimensional dilatons are embedded in a fifth dimension (cosmological time). A position in this space is defined by the following vector:

$$\bar{r} = \begin{pmatrix} r.\alpha \\ r.\beta \\ r.\gamma \\ \tau \\ \Phi \end{pmatrix} \text{ using director cosines } \alpha, \beta \text{ and } \gamma. \quad (3.1)$$

At time zero, the positions for particles 1 and 2 are given by:

$$\bar{r}_0 = \begin{pmatrix} 0 \\ 0 \\ 0 \\ 0 \\ 0 \end{pmatrix} \quad \text{and} \quad \bar{R} = \begin{pmatrix} R \\ 0 \\ 0 \\ 0 \\ 0 \end{pmatrix} \quad (3.2)$$

After a de Broglie cycle, one has these three vectors:

$$\bar{r}_0(\lambda_1) = \begin{pmatrix} 0 \\ 0 \\ 0 \\ \lambda_1 \\ \lambda_1 \end{pmatrix} \quad \text{and} \quad \bar{r} = \begin{pmatrix} r \\ 0 \\ 0 \\ \lambda_1 \\ \lambda_1 \end{pmatrix} \quad \text{and} \quad \bar{R} = \begin{pmatrix} R \\ 0 \\ 0 \\ \lambda_1 \\ \lambda_1 \end{pmatrix} \quad (3.3)$$

$\bar{r}_0(\lambda_1)$  is the unperturbed crest of the four-dimensional wave of particle 1 after a de Broglie cycle.

$\bar{r}$  is the position of the same crest under the influence of particle 2.

The k-vector is given by:

$$\bar{k} = g_{ij} \cdot k^j = \frac{2\pi}{\lambda} \begin{pmatrix} 1 & 0 & 0 & 0 & 0 \\ 0 & 1 & 0 & 0 & 0 \\ 0 & 0 & 1 & 0 & 0 \\ 0 & 0 & 0 & -1 & 0 \\ 0 & 0 & 0 & 0 & 1 \end{pmatrix} \begin{pmatrix} 1 \\ 0 \\ 0 \\ \frac{1}{2} \\ \frac{1}{2} \end{pmatrix} = \frac{2\pi}{\lambda} \begin{pmatrix} 1 \\ 0 \\ 0 \\ -1 \\ \frac{1}{2} \end{pmatrix} \quad (3.4)$$

Where  $g_{ij}$  is the local metric of the five-dimensional space. Again, cosmological distances would require a further refinement and the usage of a non-local metric. This is not required in the calculation of near-proximity forces. In the derivation of the Biot-Savart law,  $g_{ij}$  will be rewritten with regard the corresponding non-zero relative speeds. Notice the  $\frac{1}{2}$  phase dependence on k-vector, corresponding to the fifth dimension for a half-spin fat electron.

And

$$\bar{k} = \frac{2\pi}{\lambda} \begin{pmatrix} 1 & 0 & 0 & 0 & 0 \\ 0 & 1 & 0 & 0 & 0 \\ 0 & 0 & 1 & 0 & 0 \\ 0 & 0 & 0 & -1 & 0 \\ 0 & 0 & 0 & 0 & 1 \end{pmatrix} \begin{pmatrix} 1 \\ 0 \\ 0 \\ -1 \\ 0 \end{pmatrix} = \frac{2\pi}{\lambda} \begin{pmatrix} 1 \\ 0 \\ 0 \\ -1 \\ 0 \end{pmatrix} \quad (3.5)$$

for a “static zero spin neutron ” forward time traveling wave. Notice that the dilaton and the dilator are treated as one due to the QLP. Where

- $N=1\text{Kg}$  of Matter  $\cong 1000$  Avogrado's Number  $= 6.0221367360\text{E}+26$  particles of type 1.
- $\lambda_1 \cong h*1000*\text{Avogrado}/(1\text{ Kg} \times c) = 1.3310\text{E}-15$  meters ( in the MKS system).
- $\lambda_2 = \lambda_{1\text{Kg}} \cong h/(1\text{Kg} \times c) = 2.2102\text{E}-42$  meters ( in the MKS system).
- $G_{\text{Gravitational}}$  is the gravitational constant  $= 6.6720\text{E}-11 \text{ m}^3.\text{Kg}^{-1}.\text{s}^{-2}$
- Single electric charge  $(1.6022\text{E} - 19 \text{ Coulomb})$ .
- $q_e$  is the effective value of the single electric charge = charge divided by a corrective factor of  $1.004145342 = 1.59556231\text{E}-19 \text{ Coulomb}$
- $\epsilon_0$  = permittivity of the vacuum  $= 8.8542\text{E}-12 \text{ C}^2.\text{N}^{-1}.\text{m}^{-2}$  (MKS)

Starting with the standard MKS equation for electrostatic force between two one Kg bodies of electrons (one a.m.u. “electrons” or “protons”) = x Coulombs, one obtains:

$$F_{\text{Electrostatic}} = \frac{1}{4\pi\epsilon_0} \frac{(x\text{Coulomb})^2}{1\text{meter}^2} = \frac{1}{4\pi\epsilon_0} \left( \frac{N}{1\text{Kg}} 1\text{Kg} \right)^2 \frac{(q_e * \text{Coulombs} * \text{per} * \text{particle})^2}{1\text{meter}^2}$$

$$F_{\text{Electrostatic}} = \frac{1}{4\pi\epsilon_0} \left( \frac{N}{1\text{Kg}} (q_e * \text{Coulombs} * \text{per} * \text{particle}) \right)^2 \frac{(1\text{Kg})^2}{1\text{meter}^2}$$

$$G_{\text{Electrostatic}} = \frac{1}{4\pi\epsilon_0} (N.q_e)^2 = 8.29795214\text{E} + 25 \quad (3.5)$$

$$\frac{G_{\text{Electrostatic}}}{G_{\text{Gravitational}}} = \frac{8.29795214\text{E} + 25}{6.672\text{E} - 11} = 1.24369786\text{E} + 36 \quad (3.6)$$

The dilaton for a single particle can be represented by:

$$\psi_1(x, y, z, \tau, \Phi) = \frac{\cos(\bar{k}_1 \cdot \bar{r})}{1 + P.f(\bar{k}_1, \bar{r} - \bar{r}_0)} \quad (3.7)$$

where

- $||$  means absolute value
- $f(\vec{k}_1, \vec{r}) = \theta(|\vec{k}_1 \cdot \vec{r}| - 2\pi) |\vec{k}_1 \cdot \vec{r}|$
- Where  $\theta$  is the Heaviside function.
- P (absolute value of the phase volume) is 3.5 for a particle with spin half and 3 for neutral matter. The meaning of P is that for one de Broglie wavelength traversed path by the hyperspherical universe, a propagating spacetime wave spread along by a factor of  $P2\pi$  ( $7\pi$  for charged particles and  $6\pi$  for neutral-zero spin matter).

Similarly, for a 1 Kg body located at position  $\vec{R}$  :

$$\psi_2(x, y, z, \tau, \Phi) = \frac{M \cdot N \cdot \cos(\vec{k}_2 \cdot (\vec{R} - \vec{r}))}{1 + P \cdot f(\vec{k}_2, \vec{R} - \vec{r})} \quad (3.8)$$

where the effect of the 1 kg mass is implicit in the  $k_2$ -vector and expressed by the factor N. The wave intensity scales up with the number of particles (N). One kilogram of mass has 1000 moles of 1 a.m.u. “zero-spin neutrons”, or  $|k_2| = 1000 \cdot \text{Avogadro}$ .  $|k_1| = N \cdot |k_1|$ , where

- $M=1$  for neutral matter-matter or antimatter-antimatter interactions or opposite charge interactions
- $M=-1$  for neutral matter-antimatter interactions or same charge interactions

To calculate the effect of gravitational/electrostatic attraction, one needs to calculate the displacement on the crest of each particle or body wave due to interaction with the dilatons generated by the other body.

This is done for the lighter particle, by calculating the derivative of the waveform and considering the extremely fast varying gravitational wave from the macroscopic body always equal to one, since the maxima of these oscillations are too close to each other and can be considered a continuum.

The total waveform is given by:

$$\psi_{total}(x, y, z, \tau, \Phi) = \frac{\cos(\vec{k}_1 \cdot \vec{r})}{1 + P \cdot f(\vec{k}_1, \vec{r} - \vec{r}_0)} + \frac{M \cdot N}{1 + P \cdot f(\vec{k}_2, \vec{R} - \vec{r})} \quad (3.9)$$

The term  $f(\vec{k}_2, \vec{R} - \vec{r})$  contains the treatment for retarded potentials, but for simplicity we will neglect differences in dimensional time between  $\vec{R}$  and  $\vec{r}$ . Equation (3.9) is the one and only unification equation, that is, it is the four-dimensional wave equation that yields all the forces, when one consider four-dimensional wave constructive interference. It shows that anti-matter will have gravitational repulsion or anti-gravity with respect to normal matter. The derivative for  $\Psi_1$  is given by:

$$\left. \frac{\partial \psi_1(x, y, z, \tau, \Phi)}{\partial x} \right|_{\tau=\lambda_1} \cong -k_1^2 r \quad (3.10)$$

$$\nabla(P \cdot f(\vec{k}_1, \vec{r} - \vec{r}_0)) = 0 \text{ due to } |\vec{k}_1 \cdot (\vec{r} - \vec{r}_0)| \ll 2\pi.$$

Similarly

$$\left. \frac{\partial \psi_2(x, y, z, \tau, \phi)}{\partial x} \right|_{\tau=\lambda_1} \cong \frac{N^*M}{Pk_2 \cdot R^2} \quad (3.11)$$

Solving for x:

$$x = \frac{N}{Pk_1^2 k_2 \cdot R^2} = \frac{\lambda_1^2 \lambda_2 N^* M}{P(2\pi)^3 R^2} \quad (3.12)$$

There are two regimen of spacetime travel and they are depicted in Figure 7 below:

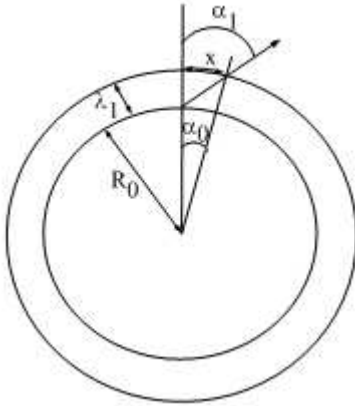

Figure 7. This figure shows the geometry of a surface bound particle. This is a X versus  $\tau$  cross-section of the hyperspherical expanding universe. Notice that the two circles represent a one de Broglie expansion of the hyperspherical universe.

At each de Broglie step both types of particles (zero and non-zero) change position by the same amount  $x$  and that defines a change in  $k$ -vector direction. The difference is with which referential that change in angle occurs. In the case of volumetric waves (non-zero spin particles), the  $k$ -vector is allowed to change by the angle  $\alpha_1$ , while in the case of superficial waves (zero spin particles), the  $k$ -vector changes just by the amount given by  $\alpha_0$  since its  $k$ -vector has to remain perpendicular to the fabric of space.  $\tan(\alpha)$  is given by  $\tan(\alpha_1)$

$=x/\lambda_1$  or by  $\tan(\alpha_0) = x/\lambda_1 * (\lambda_1/R_0)$  depending upon if the interaction is such that the particle  $k$ -vector shifts as in  $\alpha_1$  or it just acquires the radial pointing direction as in  $\alpha_0$ . A further refinement introduced by equation (3.13) below introduces a level of local deformation of the de Broglie hypersurface or fabric of space. A change in angle  $\alpha_0$  corresponds to a much smaller angle change between the radial directions (by a factor  $\lambda_1/R_0 = 9.385E-42$ , with  $R_0$  (circa 15 billion light-years) as the dimensional age of the Universe). The experimental spacetime torsion due to gravitational interaction lies someplace in between 1 and  $10^{-41}$ , thus showcasing a level of local deformation of the fabric of space. From figure 7, one calculates  $\tan(\alpha)$  as:

$$\tan(\alpha) = \frac{x}{\lambda_1} \delta = \frac{\lambda_1 \lambda_2 N}{P(2\pi)^3 R^2} \delta \quad (3.13)$$

Where  $9.385 \cdot 10^{-42} = \frac{\lambda_1}{R_0} \leq \delta \leq 1$  and  $M=1$ . It will be shown that the upper limit is valid for

charged particle interaction, while the lower limit modified by a slight deformation of the fabric of space will be associated with gravitational interaction. For the case of light, one has the following equation:

$$\tan(\alpha_0) = 1 \quad (3.14)$$

That is, light propagates with proper time projection/propagation direction  $\tau$  at  $45^\circ$  with respect to the radial time/direction. To calculate the derivative of  $\tan(\alpha)$  with respect to  $\tau$ , one can use the following relationship:

$$\frac{\partial}{\partial \tau} \tan(\alpha_0) = \frac{\tan(\alpha_0)}{\lambda_1} = \frac{\lambda_2 N}{P(2\pi)^3 R^2} \delta \quad (3.15)$$

Acceleration is given by:

$$a = c^2 \frac{\partial}{\partial \tau} \tan(\alpha_0) = \frac{c^2 \lambda_2 N}{P(2\pi)^3 R^2} \delta \quad (3.16)$$

To calculate the force between two 1 Kg masses (1000 moles of 1 a.m.u. particles) separated by one meter distance one needs to multiply equation (3.15) by 1Kg (N particles/Kg\* 1Kg):

$$F = G_{\text{Calculated}} (\delta) \frac{(1\text{Kg})^2}{(1\text{meter})^2} = - \frac{c^2 \lambda_2 * \left(\frac{N}{1\text{Kg}}\right)^2}{P(2\pi)^3} \delta \frac{(1\text{Kg})^2}{(1\text{meter})^2} \quad (3.17)$$

For  $\delta=1$  and  $P=3.5$  one obtains the  $G_{\text{Electrostatic}}$  (3.5).

$$G_{\text{Calculated}} (\delta = 1) = \frac{c^2 \left(\frac{N}{1\text{Kg}}\right) \lambda_1}{P(2\pi)^3} = 8.29795214\text{E} + 25 = G_{\text{Electrostatic}} \quad (3.18)$$

Where one made use of  $\lambda_1=N\lambda_2$  and considered the absolute value. It is important to notice that the derivation of the  $G_{\text{Calculated}}$  never made use of any electrostatic property of vacuum, charge etc. It only mattered the mass (spacetime volumetric deformation) and spin. Of course, one used the Planck constant and the speed of light and Avogadro's number. **By setting  $\delta=1$  one recovers the electrostatic value of G!**

To analyze gravitational interaction, let's consider that Hubble coefficient measurements estimate the universe as being around 15 Billion Years old or 1.418E26 meters radius. To obtain the elasticity coefficient of spacetime, let's rewrite  $\delta=(\lambda_1/R_0)\xi$  on equation (3.17) and equate the  $G_{\text{Calculated}}$  to  $G_{\text{Gravitational}}$  for two bodies of 1 Kg separated by 1 meter.

$$F = G_{\text{Gravitational}} = -6.6720 \text{ E} - 11 \frac{(1\text{Kg})^2}{(1\text{meter})^2} = - \frac{c^2 \left(\frac{N}{1\text{Kg}}\right) \lambda_1}{P(2\pi)^3} \frac{\lambda_1}{R_0} \xi \frac{(1\text{Kg})^2}{(1\text{meter})^2} \quad (3.19)$$

Where  $P=3$  since we are considering a spin-zero interaction. Solving for  $\xi$ :

$$\xi = \frac{P(2\pi)^3 R_0 G_{\text{Gravitational}}}{c^2 \left(\frac{N}{1\text{Kg}}\right) \lambda_1^2} = 8.567 \times 10^{-4} \quad (3.20)$$

If we consider that the force is given by mass times acceleration:

$$F = m_{\text{Mass}} a_x = m_{\text{Mass}} c^2 \frac{\partial \tan(\theta)}{\partial \lambda} = \frac{m_{\text{Mass}} c^2}{\lambda_1^2} \frac{\lambda_1}{R_0} \xi \cdot x \quad (3.21)$$

$$F = \frac{m_{\text{Mass}} c^2}{\lambda_1 R_0} \xi \cdot x = m_{\text{Mass}} \left(2\pi \cdot \Omega^G \text{ Universe}\right)^2 \cdot x \quad (3.22)$$

The natural frequency of spacetime oscillations is:

$$\Omega^G_{Universe} = \frac{1}{2\pi} \sqrt{\frac{c^2 \xi}{\lambda_1 R_0}} = 32.14 \text{ KHz} \quad (3.23)$$

Notice that this is not dependent upon any masses. That should be the best frequency to look for or to create gravitational waves. Of course, Hubble red shift considerations should be used to determine the precise frequency from a specific region of the universe. At last one can calculate the value of the vacuum permittivity from equations (3.5) and (3.18) as:

$$\epsilon_0 = \frac{7 \pi^2 N q_e^2}{c^2 \lambda_1} = 8.85418782 \text{ E - 12} \quad (3.24)$$

Not surprisingly, there is a perfect match between theoretical and experimental (8.85418782E-12 C<sup>2</sup>.N<sup>-1</sup>.m<sup>-2</sup>) values. The correction factor used to calculate the effective charge per particle is due to the effect of non-zero spin on matter, thus related to the particle gyromagnetic ratio. It is important to notice that this derivation don't use any parameterization. The "gyromagnetic ratio" and the "FS elasticity" are predictions of the theory, which uses only electron charge, speed of light, Avogadro's number and Planck's constant to relate it to non-hypergeometrical physics.

The complete gravitation equation is given by:

$$F_{Gravitational} = \left[ \frac{c^2 \left( \frac{N}{1Kg} \right) \lambda_1}{P(2\pi)^3} \frac{\lambda_1}{R_0} \xi \right] \frac{m_1 m_2}{R^2} \quad (3.25)$$

**Quantum aspects can be recovered by not using fast oscillation approximations.** It is also important to notice that equations (3.8) and (3.9) can be used to calculate the interaction between any particles (matter or anti-matter) or to perform quantum mechanical calculations in a manner similar to molecular dynamic simulations. The quantum character is implicit in the de Broglie wavelength stepwise quantization. It is also relativistic in essence, as it will become clear when one analyzes magnetism next.

## 3.2 Magnetic Interaction

### The Derivation of the Biot-Savart Law

Let's consider two wires with currents  $i_1$  and  $i_2$  separated by a distance  $R$ . Let's consider  $i_2$  on the element of length  $dl_2$  as the result of a moving charge of mass of 1Kg of fat electrons (one a.m.u. electrons). This is done to obtain the correct scaling factor.

Without loss of generality, let's consider that the distance between the two elements of current is given by:

$$\bar{R} = \frac{R}{\sqrt{3}} \begin{pmatrix} 1 \\ 1 \\ 1 \\ 0 \\ 0 \end{pmatrix} = R \hat{I} \quad \text{and} \quad \bar{r}_0 = \begin{pmatrix} 0 \\ 0 \\ 0 \\ 0 \\ 0 \end{pmatrix} \quad (3.26)$$

The velocities are:

$$\vec{V}_1 = v_1 \begin{pmatrix} \alpha_1 \\ \beta_1 \\ \gamma_1 \\ 0 \\ 0 \end{pmatrix} \quad \text{and} \quad \vec{V}_2 = v_2 \begin{pmatrix} \alpha_2 \\ \beta_2 \\ \gamma_2 \\ 0 \\ 0 \end{pmatrix} \quad (3.27)$$

Due to the spin half, one has after a two de Broglie cycles:

$$\vec{r} = \begin{pmatrix} \frac{r}{\sqrt{3}} \cdot (1 + \frac{v_2}{c} \alpha_2 \sqrt{3}) \\ \frac{r}{\sqrt{3}} \cdot (1 + \frac{v_2}{c} \beta_2 \sqrt{3}) \\ \frac{r}{\sqrt{3}} \cdot (1 + \frac{v_2}{c} \gamma_2 \sqrt{3}) \\ 2\lambda_1 \\ 2\lambda_1 \end{pmatrix} \quad \text{and} \quad \vec{R} = \begin{pmatrix} \frac{R}{\sqrt{3}} \\ \frac{R}{\sqrt{3}} \\ \frac{R}{\sqrt{3}} \\ 2\lambda_1 \\ 2\lambda_1 \end{pmatrix} \quad \text{and} \quad \vec{r}_0 = \begin{pmatrix} 0 \\ 0 \\ 0 \\ 2\lambda_1 \\ 2\lambda_1 \end{pmatrix} \quad (3.28)$$

Since one expects that the motion of particle 2 will produce a drag on the particle 1 along particle 2 direction of motion.

The figure below showcase the geometry associated with these two currents.

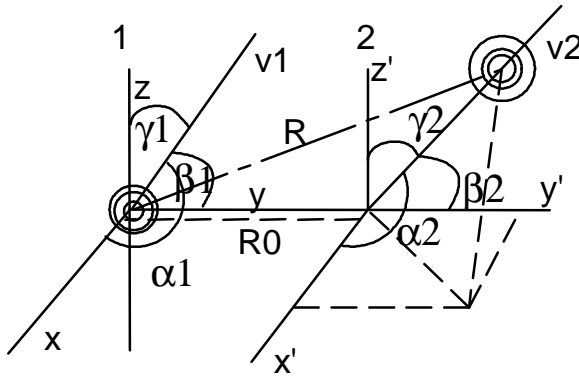

Figure 8. Derivation of Biot-Savart law using spacetime waves.

Notice also that the effect of the  $\frac{1}{2}$  spin is to slow down the rate of phase variation along the dimensional time  $\tau$  in half.

In the case of currents, the velocities are not relativistic and one can make the following approximations to the five-dimensional rotation matrix or metric:  $\cosh(\alpha) \cong 1$  and  $\sinh(\alpha_i) \cong v_i/c$  where  $v_i$  is the velocity along the axis  $i$ .

The k-vectors for the two electrons on the static reference frame are given by:

$$\bar{k}_1 \cong \frac{2\pi}{\lambda_1} \begin{bmatrix} 1 & 0 & 0 & -\alpha_1 \frac{v_1}{c} & 0 \\ 0 & 1 & 0 & -\beta_1 \frac{v_1}{c} & 0 \\ 0 & 0 & 1 & -\gamma_1 \frac{v_1}{c} & 0 \\ -\alpha_1 \frac{v_1}{c} & -\beta_1 \frac{v_1}{c} & -\gamma_1 \frac{v_1}{c} & -1 & 0 \\ 0 & 0 & 0 & 0 & 1 \end{bmatrix} \begin{bmatrix} \frac{1}{\sqrt{3}} \\ \frac{1}{\sqrt{3}} \\ \frac{1}{\sqrt{3}} \\ \frac{1}{\sqrt{3}} \\ \frac{1}{2} \end{bmatrix} \cong \frac{2\pi}{\lambda_1} \begin{bmatrix} \frac{1}{\sqrt{3}} + \alpha_1 \frac{v_1}{c} \\ \frac{1}{\sqrt{3}} + \beta_1 \frac{v_1}{c} \\ \frac{1}{\sqrt{3}} + \gamma_1 \frac{v_1}{c} \\ -\left(\alpha_1 \frac{v_1}{c} + \beta_1 \frac{v_1}{c} + \gamma_1 \frac{v_1}{c}\right) - 1 \\ \frac{1}{2} \end{bmatrix} \quad (3.29)$$

Similarly:

$$\bar{k}_2 \cong \frac{2\pi}{\lambda_2} \begin{bmatrix} \frac{1}{\sqrt{3}} + \alpha_2 \frac{v_2}{c} \\ \frac{1}{\sqrt{3}} + \beta_2 \frac{v_2}{c} \\ \frac{1}{\sqrt{3}} + \gamma_2 \frac{v_2}{c} \\ -\alpha_2 \frac{v_2}{c} - \beta_2 \frac{v_2}{c} - \gamma_2 \frac{v_2}{c} - 1 \\ \frac{1}{2} \end{bmatrix} \quad (3.30)$$

The wave intensities at  $\bar{r}$  are:

$$\psi_1(x, y, z, \tau, \Phi) = \frac{\cos(\bar{k}_1 \cdot \bar{r})}{1 + P \cdot f(\bar{k}_1, \bar{r} - \bar{r}_0)} \quad (3.31)$$

$$\psi_2(x, y, z, \tau, \Phi) = \frac{M \cdot \cos(\bar{k}_2 \cdot (\bar{R} - \bar{r}))}{1 + P \cdot f(\bar{k}_2, \bar{R} - \bar{r})} \quad (3.32)$$

Where  $N = 1000$  Avogadro,  $\lambda_1 =$  de Broglie wavelength of a one a.m.u (atomic mass unit) particle,  $\lambda_2 =$  de Broglie wavelength of a 1Kg particle  $= \lambda_1/N$ .

Now one can calculate:

$$\bar{k}_1 \cdot (\bar{r} - \bar{r}_0) \cong \frac{2\pi}{\lambda_1} \begin{bmatrix} \frac{1}{\sqrt{3}} + \alpha_1 \frac{v_1}{c} \\ \frac{1}{\sqrt{3}} + \beta_1 \frac{v_1}{c} \\ \frac{1}{\sqrt{3}} + \gamma_1 \frac{v_1}{c} \\ \left(-\alpha_1 \frac{v_1}{c} - \beta_1 \frac{v_1}{c} - \gamma_1 \frac{v_1}{c}\right) - 1 \\ \frac{1}{2} \end{bmatrix} \begin{bmatrix} \frac{r}{\sqrt{3}} \cdot \left(1 + \frac{v_2}{c} \alpha_2 \sqrt{3}\right) \\ \frac{r}{\sqrt{3}} \cdot \left(1 + \frac{v_2}{c} \beta_2 \sqrt{3}\right) \\ \frac{r}{\sqrt{3}} \cdot \left(1 + \frac{v_2}{c} \gamma_2 \sqrt{3}\right) \\ \frac{r}{\sqrt{3}} \cdot \frac{v_2}{c} \\ 0 \\ 0 \end{bmatrix} = \frac{2\pi}{\lambda_1} \left( 1 + \frac{\bar{V}_1 \cdot \hat{R}}{c} + \frac{\bar{V}_2 \cdot \hat{R}}{c} + \frac{\bar{V}_1 \cdot \bar{V}_2}{c^2} \right) \quad (3.33)$$

$$\bar{k}_1 \cdot \bar{r} \cong \frac{2\pi}{\lambda_1} \left( 1 + \frac{\bar{V}_1 \cdot \hat{R}}{c} + \frac{\bar{V}_2 \cdot \hat{R}}{c} + \frac{\bar{V}_1 \cdot \bar{V}_2}{c^2} \right) + 2\pi \quad (3.34)$$

$$\nabla(\bar{k}_1 \cdot (\bar{r} - \bar{r}_0)) = \nabla(\bar{k}_1 \cdot \bar{r}) \cong \frac{2\pi}{\lambda_1} \left( 1 + \frac{\bar{V}_1 \cdot \hat{R}}{c} + \frac{\bar{V}_2 \cdot \hat{R}}{c} + \frac{\bar{V}_1 \cdot \bar{V}_2}{c^2} \right) \hat{R} \quad (3.35)$$



$$\nabla(P.f(\bar{k}_1, \bar{r}-\bar{r}_0)) \cong 0 \text{ due to } \left| \bar{k}_1 \cdot (\bar{r}-\bar{r}_0) \right| \ll 2\pi.$$

Similarly:

$$\bar{k}_2 \cdot (\bar{R}-\bar{r}) \cong \frac{2\pi}{\lambda_2} \begin{bmatrix} \frac{1}{\sqrt{3}} + \alpha_2 \frac{v_2}{c} \\ \frac{1}{\sqrt{3}} + \beta \frac{v_2}{2c} \\ \frac{1}{\sqrt{3}} + \gamma_2 \frac{v_2}{c} \\ \left(-\alpha_2 \frac{v_2}{c} - \beta_2 \frac{v_2}{c} - \gamma_2 \frac{v_2}{c}\right) - 1 \\ \frac{1}{2} \end{bmatrix} \begin{pmatrix} \frac{R}{\sqrt{3}} - \frac{r}{\sqrt{3}} \cdot \left(1 + \frac{v_2}{c} \alpha_2 \sqrt{3}\right) \\ \frac{R}{\sqrt{3}} - \frac{r}{\sqrt{3}} \cdot \left(1 + \frac{v_2}{c} \beta_2 \sqrt{3}\right) \\ \frac{R}{\sqrt{3}} - \frac{r}{\sqrt{3}} \cdot \left(1 + \frac{v_2}{c} \gamma_2 \sqrt{3}\right) \\ 0 \\ 0 \end{pmatrix} \cong \frac{2\pi R}{\lambda_2} \left(1 + \frac{\bar{V}_2 \cdot \hat{R}}{c}\right) \quad (3.36)$$

$$\nabla(f(\bar{k}_2, \bar{R}-\bar{r})) \cong \frac{2\pi}{\lambda_2} \begin{bmatrix} \frac{1}{\sqrt{3}} + \alpha_2 \frac{v_2}{c} \\ \frac{1}{\sqrt{3}} + \beta \frac{v_2}{2c} \\ \frac{1}{\sqrt{3}} + \gamma_2 \frac{v_2}{c} \\ \left(-\alpha_2 \frac{v_2}{c} - \beta_2 \frac{v_2}{c} - \gamma_2 \frac{v_2}{c}\right) - 1 \\ \frac{1}{2} \end{bmatrix} \begin{pmatrix} -\frac{1}{\sqrt{3}} \cdot \left(1 + \frac{v_2}{c} \alpha_2 \sqrt{3}\right) \\ -\frac{1}{\sqrt{3}} \cdot \left(1 + \frac{v_2}{c} \beta_2 \sqrt{3}\right) \\ -\frac{1}{\sqrt{3}} \cdot \left(1 + \frac{v_2}{c} \gamma_2 \sqrt{3}\right) \\ 0 \\ 0 \end{pmatrix} = -\frac{2\pi}{\lambda_2} \left(1 + \frac{\bar{V}_2 \cdot \hat{R}}{c}\right) \hat{R} \quad (3.37)$$

Hence:

$$\nabla \psi_1(x, y, z, \tau, \Phi) \cong -\frac{\nabla(\bar{k}_1 \cdot \bar{r})}{1 + P.f(\bar{k}_1, \bar{r}-\bar{r}_0)} \sin(\bar{k}_1 \cdot \bar{r}) \quad (3.38)$$

$$\nabla \psi_1(x, y, z, \tau, \Phi) \cong -\left(\frac{2\pi}{\lambda_1}\right)^2 \left(1 + \frac{\bar{V}_1 \cdot \hat{R}}{c} + \frac{\bar{V}_2 \cdot \hat{R}}{c} + \frac{\bar{V}_1 \cdot \bar{V}_2}{c^2}\right)^2 r \hat{R} \quad (3.39)$$

And

$$\nabla \psi_2(\bar{r}, \tau, \Phi) \cong -\frac{P \nabla(f(\bar{k}_2, \bar{R}-\bar{r}))}{(1 + P.f(\bar{k}_2, \bar{R}-\bar{r}))^2} = -\frac{1}{P \frac{2\pi}{\lambda_2} \left(1 + \frac{\bar{V}_2 \cdot \hat{R}}{c}\right)} \frac{\hat{R}}{R^2} \cong -\left(\frac{\lambda_2}{2\pi P}\right) \left(1 - \frac{\bar{V}_2 \cdot \hat{R}}{c}\right) \frac{\hat{R}}{R^2} \quad (3.40)$$

Thus,

$$r_{ee} \cong -\frac{\left(\frac{\lambda_2}{2\pi P}\right) \left(1 - \frac{\bar{V}_2 \cdot \hat{R}}{c}\right) \frac{\hat{R}}{R^2}}{\left(\frac{2\pi}{\lambda_1}\right)^2 \left(1 + \frac{\bar{V}_1 \cdot \hat{R}}{c} + \frac{\bar{V}_2 \cdot \hat{R}}{c} + \frac{\bar{V}_1 \cdot \bar{V}_2}{c^2}\right)^2} \cong -\left(\lambda_1^2 \lambda_2\right) \frac{\left(1 - \frac{\bar{V}_2 \cdot \hat{R}}{c}\right) \left(\hat{R} \cdot \hat{R} - 2 \frac{\bar{V}_1 \cdot \hat{R}}{c} - 2 \frac{\bar{V}_2 \cdot \hat{R}}{c} - 2 \frac{\bar{V}_1 \cdot \bar{V}_2}{c^2}\right) \frac{\hat{R}}{R^2}}{(2\pi)^3 P} \quad (3.41)$$

$$r_{ee} \cong -\left(\lambda_1^2 \lambda_2\right) \frac{\left(\hat{R} \cdot \hat{R} - 2 \frac{\bar{V}_1 \cdot \hat{R}}{c} - 2 \frac{\bar{V}_2 \cdot \hat{R}}{c} - 2 \frac{\bar{V}_1 \cdot \bar{V}_2}{c^2} - 2 \frac{\bar{V}_2 \cdot \hat{R}}{c} + 2 \left(\frac{\bar{V}_1 \cdot \hat{R}}{c}\right) \left(\frac{\bar{V}_2 \cdot \hat{R}}{c}\right) + 2 \left(\frac{\bar{V}_2 \cdot \hat{R}}{c}\right) \left(\frac{\bar{V}_2 \cdot \hat{R}}{c}\right) + 2 \left(\frac{\bar{V}_1 \cdot \bar{V}_2}{c^2}\right) \left(\frac{\bar{V}_2 \cdot \hat{R}}{c}\right)\right) \frac{\hat{R}}{R^2}}{(2\pi)^3 P} \quad (3.42a)$$

$$r_{ep} \cong +(\lambda_1^2 \lambda_2) \left( \frac{\hat{R} \cdot \hat{R} - 2 \frac{\vec{V}_1 \cdot \hat{R}}{c}}{(2\pi)^3 P} \right) \frac{\hat{R}}{R^2} \quad \text{since } v_2=0 \quad (3.42b)$$

$$r_{pe} \cong (\lambda_1^2 \lambda_2) \left( \frac{\hat{R} \cdot \hat{R} - 2 \frac{\vec{V}_2 \cdot \hat{R}}{c} - 2 \frac{\vec{V}_2 \cdot \hat{R}}{c} + 2 \left( \frac{\vec{V}_2 \cdot \hat{R}}{c} \right) \left( \frac{\vec{V}_2 \cdot \hat{R}}{c} \right)}{(2\pi)^3 P} \right) \frac{\hat{R}}{R^2} \quad \text{since } v_1=0 \quad (3.42c)$$

$$r_{pp} \cong (\lambda_1^2 \lambda_2) \left( \frac{\hat{R} \cdot \hat{R}}{(2\pi)^3 P} \right) \frac{\hat{R}}{R^2} \quad \text{since } v_1=v_2=0 \quad (3.42d)$$

$$r_{total} \cong r_{ee} + r_{ep} + r_{pe} + r_{pp} = -(\lambda_1^2 \lambda_2) \left( \frac{2 \left( \frac{\vec{V}_1 \cdot \hat{R}}{c} \right) \left( \frac{\vec{V}_2 \cdot \hat{R}}{c} \right) - 2 \left( \frac{\vec{V}_1 \cdot \vec{V}_2}{c^2} \right) \left( 1 - \left( \frac{\vec{V}_2 \cdot \hat{R}}{c} \right) \right)}{(2\pi)^3 P} \right) \frac{\hat{R}}{R^2} \quad (3.42f)$$

Where p stands for proton and e for electron.

$$r \cong -(\lambda_1^2 \lambda_2) \left( \frac{-2 \frac{\vec{V}_1 \cdot \vec{V}_2}{c^2} + 2 \left( \frac{\vec{V}_1 \cdot \hat{R}}{c} \right) \left( \frac{\vec{V}_2 \cdot \hat{R}}{c} \right)}{(2\pi)^3 P} \right) \frac{\hat{R}}{R^2} \quad (3.43)$$

$$r \cong 2(\lambda_1^2 \lambda_2) \left( \frac{[V_1 \otimes (V_2 \otimes \hat{R})] \cdot \hat{R}}{(2\pi)^3 P c^2} \right) \frac{\hat{R}}{R^2} \quad (3.44)$$

Where non-velocity dependent and single velocity dependent contributions were neglected due to the counterbalancing wave contributions from static positively charged centers.

The force is given by:

$$\vec{F} = c^2 \frac{\partial \tan(\alpha)}{\partial \tau} = c^2 \frac{r}{2\lambda_1^2} = \frac{\lambda_2}{(2\pi)^3 P} ([V_1 \otimes (V_2 \otimes \hat{R})] \cdot \hat{R}) \frac{\vec{R}}{R^3} = \frac{\lambda_2 v_1 \cdot v_2}{(2\pi)^3 P} ([d\hat{i}_1 \otimes (d\hat{i}_2 \otimes \hat{R})] \cdot \hat{R}) \frac{\vec{R}}{R^3} \quad (3.45)$$

Where one took into consideration that a particle with spin half has a cycle of  $2\lambda_1$  instead of  $\lambda_1$ .

The Biot-Savart law can be written as:

$$d\vec{F} = \frac{\mu_0 I_1 I_2 (d\vec{l}_1 \cdot d\vec{l}_2) \vec{x}_{12}}{4\pi |\vec{x}_{12}|^3} \quad (3.46)$$

Comparing the two equations one obtains:

$$\frac{\mu_0}{4\pi} = \frac{\lambda_2}{(2\pi)^3 q_e^2 P} \quad (3.47)$$

Thus

$$\mu_0 = \frac{\lambda_2}{2\pi^2 q_e^2 P} \quad (3.48)$$

From equation (3.24)

$$\epsilon_0 = \frac{2 P \pi^2 N q_e^2}{c^2 \lambda_1}$$

Thus

$$\mu_0 \cdot \epsilon_0 = \frac{\lambda_2}{2 P \pi^2 q_e^2} \frac{2 P \pi^2 N q_e^2}{c^2 \lambda_1} = \frac{1}{c^2} \quad (3.49)$$

Thus one recovers the relationship between  $\mu_0$  and  $\epsilon_0$ .

### 3.3 Grand Unification Supersymmetry

As the dimensional age of the universe becomes smaller, the relative strength of gravitation interaction increases. Conversely, one expects that as the universe expands gravity will become weaker and weaker. This and the four-dimensional light speed expanding hyperspherical universe topology explain the acceleration of expansion without the need of anti-gravitational dark matter.

For gravitation the spring coefficient is given by:

$$F = m_{neutron} * a_x = m_{neutron} c^2 \frac{\partial \tan(\theta)}{\partial \lambda} = \frac{m_{neutron} c^2}{\lambda_1^2} \frac{8.56610^4 \lambda_1}{R_0} x = \kappa_g x \quad (3.50)$$

Similarly for electrostatic interaction, one has:

$$F = m_{neutron} * a_x = m_{neutron} c^2 \frac{\partial \tan(\theta)}{\partial \lambda} = \frac{m_{neutron} c^2}{\lambda_1^2} x = \kappa_e x \quad (3.51)$$

$$\text{Thus } \frac{\kappa_g}{\kappa_e} = \frac{8.56610^4 \lambda_1}{R_0} \quad (3.52)$$

Thus when  $R_0$  was smaller than  $8.56610^4$  times  $\lambda_1$  (3.8E-19s), gravitational and electromagnetic interactions had equal strength. They were certainly indistinguishable when the radius of the universe was one de Broglie wavelength long. This section is called Grand unification supersymmetry, because condition (3.52) plays the role of the envisioned group theoretical supersymmetry of the grand unification force in future theories. Of course, it has a geometrical interpretation. At that exact radius, an elastic spring constant of the fabric of space allows for a change in the local normal such that it is parallel to the redirection of k-vector of a freely moving dilator. This is not what most scientists in this field expected but science is not about expectations.

## 4 Conclusions:

The hypergeometrical theory, a model that considers the interference of four-dimensional wave on the hypersurface of a hyperspherical expanding universe was introduced.

The complexity of the present description of the universe in our sciences<sup>4-6</sup> is assigned to the fact that one is dealing with four-dimensional projections of a five dimensional process. Our inability to realize that made the description unnecessarily complex.

These are the ingredients for a new and simple formulation of Physics:

- A new quantum Lagrangian principle (QLP) was proposed.

- Quantum gravity, electrostatics and electromagnetism were derived using the same equations (QLP), same framework. The theory is inherently quantum mechanical.
- The quantum version of this theory is readily achieved just by eliminating the high mass or short wavelength approximation on equation (3.9). It is outside the scope of this paper to implement hypergeometrical universe quantum algorithms. In a fully geometric theory, there are no energy or mass quanta. Motion is quantized by the QLP. All the other quantizations can be recovered from that.
- Two fundamental parameters of the universe were calculated from the first principles (permittivity and magnetic susceptibility of vacuum).
- Biot-Savart law was derived from the first principles.
- Grand unification supersymmetry conditions for the time when all forces were equal were derived from simple geometrical considerations.
- The fabric of space can be considered to be the regions of the hypersphere where the normal to its local space is pointing in the radial direction. Any region where that happens has a distinct and yet undistinguishable character. It is distinct because it is pointing in the direction of the universe expansion, but it is indistinguishable within the four-dimensional (relativistic) perspective. All reference frames are equivalent within a four-dimensional perspective. They become distinct but not distinguishable under a five-dimensional analysis.
- The natural frequency of spacetime oscillations is derived to be 32.14 KHz.
- Mach's non-local gravitational interaction explanation for inertia is replaced by a hypergeometrical local fabric of space distortion argument.
- Mach's and Newton's absolute times are assignable to the cosmological time. That time is absolute but can only be measured by observing the expansion of the four-dimensional hyperspherical universe.
- 3D and 4D masses were defined in terms of 3D projections of a 4D volume at specific phases of the hypergeometrical universe expansion 4D masses were the corresponding mass within a de Broglie expansion cycle
- Pseudo time-quantization was proposed.
- A fundamental dilator corresponding to both the proton and the electron was proposed. Particles were modeled as coherences between two 4D deformation states of a rotating 4D double potential well.
- Dilatons from the fundamental dilator were proposed to be light speed traveling metric modulations generated as the dilator tunnels from one state to the other, thus changing character from electron to proton and vice-versa. Anti-matter was proposed to be the same dilator just with a negative phase.
- Since all non-exotic matter (elements, electrons, neutrons, protons, anti-elements, anti-electrons, anti-neutrons and anti-protons) were proposed to be composed of the same dilator, a cosmological coherence is derived.
- Exotic matter (hyperons) is proposed to be the more complex coherences shown in Appendix A. Nuclear energy is proposed to be stored in deformations of the fabric of space resulting from mismatch of tunneling and tumbling processes within a complex coherence period. The mismatching would result in a tilted state at the de Broglie phases

of the Cosmological Coherence. It is proposed that interaction of these particles with the Universe through the QLP, requires that the beginning and final states to be flat on the 3D hypersurface and that any distortion to be distributed among sub-coherences. The amount of tilting on the individual sub-coherences is recovered at the moment of decay.

- Higher degrees of internal tilting can be achieved by non-fundamental sub-coherences. The higher the degree of internal tilting the lower the element or isotope lifetime.
- The only “force” is due to dilaton-dilator interactions subject to the quantum Lagrangian principle. There is no need for intermediating virtual particles to convey different forces.
- Particle decay, as opposed to collisional reactions, can be explained by nonlinear optics methods or standard barrier tunneling methods – quantum chemistry methodology. Of course, to create quantum chemistry methodology one has to have the Schrodinger equation for the 4D deformation rotating double well potential. This is outside the scope of this paper.
- There is a dilaton bath from which one can envision virtual dilators popping into existence, but it is not clear they are needed at all. Current science does not have the dilaton field, thus under those condition, virtual particles are need to explain nuclear chemistry. Notice that a dilator field is a matter field, that is, it is a function of the proximity of matter and not a property of empty space. It decays as one goes away from matter and thus it doesn’t blow up as vacuum zero point fluctuations would. This is at the heart of the solution to the action-at-distance paradox. The photon decay is due to dephasing of the electronic coherence due to interaction with the dilaton black body field from the **detectors themselves**. Since the radiation arriving from the detector on the emitting molecule is polarized (by the polarizers), the outgoing photon will know its polarization at the moment of emission and not at the moment of interaction with the polarizers. **This eliminates the need of infinite velocity and thus eliminates the action-at-distance paradox.**
- The black body radiation due to dilators thermal fluctuations is not polarized and normally average to nothing. Thermal fluctuations are uncorrelated and isotropic. Any coherent motion will have a corresponding dilaton coherence along their 4D trajectory and a de Broglie projection in the 3D universe. This 3D de Broglie projection is real, that is, it is independent upon a single electron and at the same time it is dependent upon each and every electron in the coherent flow. The double slit experiment is done with a monochromatic flow of electrons passing through two slits. Due to the QLP, electrons will travel or surf the 4D dilaton field. That will have a 3D projection, which means that the electron will also surf the 3D projection of this dilaton field. We propose that the electron does not pass the two slits at the same time. It surfs a de Broglie dilaton projection that will create an interferometric pattern after the slits. Since the electron follows the dilaton field before and after the slits, it will follow the interferometric pattern and deposit accordingly. **Thus the electron in the double slit experiment does not need to pass through both slits at the same time.**
- Dilatons and standard collisional excitation should suffice in this theory. In the same way that electronic transitions can be created by collisions, dilator collisions can create 4D deformation transitions. These transitions, if accompanied with the creation of new coherences will interact with the existing universe otherwise they would just disappear. The appropriate description of the 4D deformational rotating double potential well and the dilator rotational dynamics will be described elsewhere.

- A refinement on the fundamental dilator model is to consider it a four-dimensional ellipsoid of revolution with a 3D projection of the 4D volume proportional to the particle mass and three axes' length quantum numbers equal to the corresponding quark composition. This is a zero 4D Volume sum rule for all the particles in the universe. Matter is energy and energy cannot be destroyed. 4D displacement volumes can! They have signs and any cosmogenesis theory basic on them will be able to **reduce the whole universe to a fluctuation of zero**. A simple hypergeometrical universe cosmogenesis theory will be presented in a companion paper
- Since quarks are modeled as quantum numbers (axis lengths) of a volume, they cannot be separated in the same way one cannot separate the X dimension from a three-dimensional object. Structured scattering, which has been used as an indication of the existence of quarks, can be easily understood as an indication of the existence of a form or shape, that is, particles are not spheres. Other dimensions of the standard model are modeled as rotations. Spin is modeled as a rotation perpendicular to radial direction and one spatial coordinate (x, y or z). Three/two additional dimensions are captured as rotational degrees of freedom for rotation along the three/two spatial axes.
- Matter and anti-matter should present anti-gravitational interaction, that is, they should repel each other with the corresponding gravitation strength.
- Planck's constant has a new meaning within this theory. It is the proportionality constant that ensures that the de Broglie wavelength, relating the observed 3D mass and 3D velocities, matches the 3D projection of the 4D dilaton. Notice that the 4D dilaton wavelength (frequency) depends only upon the gap between the two states of the fundamental dilator. This mapping is done through the linear momentum equation  $h=m.v.\lambda$ .

## Cosmological Conclusions:

The hyperspherical expanding universe has profound cosmological implications:

- The expanding hypersphere clearly shows in geometrical terms that any position (cosmological angle) in the hypersurface (3-D universe) has a Hubble receding velocity.
- The HubbleVel, the Hubble cosmological expansion velocity at a cosmological angle  $\theta$  (see Figure 1) is given by
  - $HubbleVel = c\theta$
  - This means that the three-dimensional space is expanding at the Hubble cosmological expansion velocity (speed of light per radian) as the hypersphere moves outwards along the radial time direction.
  - The corresponding elicited motions to all interactions in the universe are just side-drifts from a light-speed travel along the radial time direction. This explains why the speed of light is the limiting speed in our Universe. **It is the only velocity anything can move.**

## Conclusions about Time

- This model contains one absolute time, the Cosmological Time and time projections for each inertial frame of reference.
- Although absolute, one cannot measure time using the Cosmological Time, unless one observes directly the Hyperspherical Expansion of The Universe.

- Our universe corresponds to the  $X\tau$  cross-section shown in figure 1. There one can only measure the relative angle between  $\tau$  and  $\tau'$ , and thus only the relative passage of time.

Hence time can be both **Absolute** and **Relative** and both Einstein and Newton were right.

### Astronomical Conclusions:

- The entire Universe is contained in a very thin three-dimensional hypersurface of a four-dimensional hypersphere of radius  $c \cdot [\text{Age of The Universe}]$ .
- The thickness of this hypersurface varies depending upon which dilator state is in phase with the 3D Universe. Electrons thickness is about 2000 times higher than the one for the proton.
- The average radius of curvature of this hypersurface is exactly the speed of light times the age of the Universe, or  $R=15$  billion light-years or so.
- The visible Universe volume is given by:  $VisibleUniverseVolume = \frac{4\pi R^3}{3}$ .
- The whole (Visible plus Invisible) Universe should have a volume of  $UniverseVolume = \frac{4\pi(\pi R)^3}{3}$ . The actual radius of the Universe is  $\pi R$  or around 47 billion light-years.
- Beyond the visible Universe lies the Never-to-be-Seen-Universe, whose linear dimension is actually  $(2\pi-2)$  times the dimensional time radius of the hypersphere.  $3\pi/2R$  of the Universe linear dimension can never be reached
- Of course, the four-dimensional light speed expanding hypersurface topology also explains why the Big Bang radiation comes from all directions and why one cannot ever locate a simple point where the Big Bang occurred. The Big Bang will always seem to have occurred in any direction if one looks far enough (the dimensional age of the Universe) and that is the result of four-dimensional explosion dynamics.
- The other topology derived conclusion is that if one could “see and measure velocity using Cosmological Time” farther than the dimensional time radius of the Universe, galaxies would be traveling at speeds faster than the speed of light with respect to us. This wouldn't be the case if we measure any velocity using cross-reference time  $\tau$ . Under those circumstances the maximum velocity is always  $c$ .
- The fact that it is impossible to “see” any farther than the dimensional radius of the Universe means that the postulate of Relativity remains semi-solid. If one travels far enough but not as far as the age of dimensional radius of the Universe, one still could travel at absolute speeds faster than the speed of light.
- The highest absolute receding speed of this Universe is  $\pi c$ , which is the real speed bump in the whole Universe. Absolute receding speeds are measure with respect to the Cosmological Time  $\Phi$ .
- Since the receding speed of the Big Bang is equal to the speed of light, all its electromagnetic energy is Doppler shifted by the time they arrive at us, thus one cannot ever observe the Big Bang with a telescope. On the other hand, one can probe the initial dynamics by looking as far as one can with a large telescope.

- The Cosmic Microwave Background is likely to be Doppler Shifted Gamma Radiation and not Blackbody Equilibrium Radiation.
- Another corollary of this theory is the Hubble conclusion about an expanding hyperspherical Universe. The speed of light divided by the average numerical value for the Hubble constant is the inverse of the Age of the Universe (e.g. 16.4 Billion years, 55 Km/s per megaparsec with one megaparsec = 3 million light years). The averaging is necessary since if one looks at any direction, there will be debris from the Big Bang (Galaxies) of different sizes traveling towards and from your direction.
- The topology offers the revolutionary perception that while we see ourselves at rest we are actually traveling at the speed of light in a direction perpendicular to all the three dimensions we can perceive in our daily life. General Relativity and present Cosmology has no qualms associating a Black Hole with a disturbance of spacetime continuum. Since we could easily fall into a Black Hole, it is not surprising that we should be modeled as a disturbance of the spacetime continuum in a similar manner. Like any disturbance, there is a natural propagation velocity, in our case that velocity is  $c$  (the speed of light).
- One can easily see that the Big Bang occurred when the Universe was an infinitesimally small circle across each one of the three dimensions, thus it spanned the whole Universe. It occurred on all places at the same time. This is the basis for the non-locality of the Big Bang in a three-dimensional Universe projection. This means that in our Universe, the Big Bang occurred exactly where we are no matter where we are. The heat, horrendous explosion and debris has long since left this region and now one only can see the beginning of the Universe if one looks very far away to see the debris that traveled the age of the Universe and are only now reaching us. This is a quite surprising and elegant conclusion.
- Due to the topology of a four-dimensional Big Bang, the center of the Universe is a location in the radial direction and not in 3D space.
- Unlike motions along other directions of the four dimensional space, travel along the radial time occurs only at the speed of light.
- The visible Universe corresponds to a hyper-cap in this hypersphere. The hyper-cap radius is also the age of the Universe, which is also the average radius of curvature of the hypersphere. Thus the Universe is not only finite but also curved: a perfect circle.
- Despite of that one cannot travel around it (due to its expansion at the speed of light) and due to the limit imposed on the highest traveling speed in this Universe. Finite, circular but impossible to traverse.
- In addition, the hypersphere model makes any point in the Universe equivalent to another; in the same way that no point on the surface of an expanding balloon is closer to the origin of times (its center or the point in space defined by the balloon when it was very small).
- The fact that we cannot see the past or travel there is because it does not exist any longer, due to the extremely thin character of the hyperspherical Universe. It is only a de Broglie wavelength thick. Needless to say, one cannot either travel to the future because it doesn't exist yet. We can only reach the future when it is the present, since we are traveling there even as we speak.
- Beyond the Big Bang lies more of the same (Universe), albeit invisible Universe. The furthest visible part of the Universe is the Big Bang, that doesn't mean that one could traveling faster than the speed of light go there and see it first hand. It only means that if we travel at the speed of light in any direction, the cosmic microwave background will Doppler



shift into gamma rays (a possible tremendous inconvenience for light speed travelers) and one will be able to actually see the beginning. From Figure 1, it is clear that the hypersphere is uniform and that traveling in any direction wouldn't bring us into the past. The hypersphere travels inexorably into the future.

- It becomes clear that the Hubble expansion theory has to be modified to accommodate a four-dimensional Big Bang. The change is that in a four-dimensional explosion the Big Bang occurred in each and every point of the initial circumference, that is, the Big Bang occurred in each and every point of the Universe at the same time. From each and every point, energy and matter were ejected by tremendous forces. This means, that at any given point of the Universe there is a three dimensional isotropic expansion and thus the average Hubble constant is equal to the inverse of the dimensional age of the Universe times the speed of light. In a three-dimensional Big Bang, matter would expand radially from a single point, thus the Universe would be highly anisotropic and the Hubble constant would be a constant.
- Finally, the relativistic effects and inertia are due to local distortions of the curvature of this hyperspherical surface. The highest distortion one can create is to travel at the speed of light. That corresponds to having one's proper dimensional time vector  $\tau$  at 45 degrees with the three-dimensional space. Different regions of the hypersurface have different tangents with respect to an originating point, thus flow of observed time will depend upon how fast and how far you travel. One does have receding velocities that are larger than the speed of light, indicating the Relativity is a local approximation of Universe dynamics.
- Appendix B showcase modifications to Relativity that allows for the higher than the speed of light receding speeds expected in a hyperspherical expanding Universe. It also shows the correct way to add receding speeds over Cosmological distances.

## Grand Unification Conclusions

- The meaning of physical existence is being phase-matched along the radial direction.
- Appendix B shows that one can see all the way up to the Big Bang (or thereabouts), but one can only reach a Cosmological angle of  $\pi/4$  due to the Universe expansion.
- Quarks are modeled as positive and negative axes' length of the ellipsoid of revolution. A negative axis length means that the four-dimensional wave generated along that axis direction has a negative phase (180 degrees phase shift). The directionality of waves will only play a role when one discusses polarized matter (see DeltaPlus and SigmaPlus hyperons in Appendix A). From this description it becomes evident that antimatter should produce anti-gravity. This is supported by the grand unification equations presented in section 3.
- Appendix A indicates that the conversion of matter to antimatter is done through half-neutrinos interaction with matter. Cross-section for neutrino splitting might be low, thus explaining why there is an asymmetry in the proportions of matter and antimatter in the Universe.
- The light speed, fast expanding hypersphere model of the Universe allows for the existence of an infinite number of other hyperspherical expanding Universes, separated by dimensional time intervals. The source of "matter and energy" will be explained in the Cosmogenesis paper of this series. Although there is an allowance, it will be described that the Big Bang occurred simultaneously with Dimensional Transitions. This seems to preclude the coexistence of Hyperspherical Universes.

- The fate of the Universe is continuous expansion. It will become clear how the Universe recycles itself and what is the meaning of recycling in the Cosmogenesis paper.

### Fundamental Conclusion:

A last conclusion worth mentioning is a modification of Newton’s first law:

**In the absence of interactions, a body (locally deformed FS region) will drift within the hypersurface (3-D universe) until  $\tau$  and R are parallel again or conversely until it reaches a point where its drift velocity equals the Hubble velocity of that region of space.**

Notice that the apparent motion will still exist since the fabric of space is expanding and any place in the 3D universe has a Hubble expansion velocity. Although moving relatively to its original position, the body remains static with respect to the fabric of space ( $\tau$  parallel to R). At that point, the local deformation ceases to exist and the body drifts with the expansion at the Hubble velocity. In other words, motion is a way for 4D space to relax; in the same way a tsunami is the means for the sea to regain a common level.

### Appendix A- Hypergeometrical Standard Model

Here is a brief description of the Hypergeometrical Standard Model. A full description will be published elsewhere.

The Fundamental Dilator is modeled as a coherence between two 4D deformational stationary states of a double potential.

The quantum numbers, associated with the 4D deformational states, are modeled as axes’ lengths of a 4D ellipsoid of revolution. Negative values correspond to 180 degrees in phase with respect to a dilator with a positive axis. This means that when the positive dilator is expanding the 4D space, the negative dilator is shrinking 4D space.

Below is a diagram showing the states involved with the fundamental dilator.

#### Electron Model

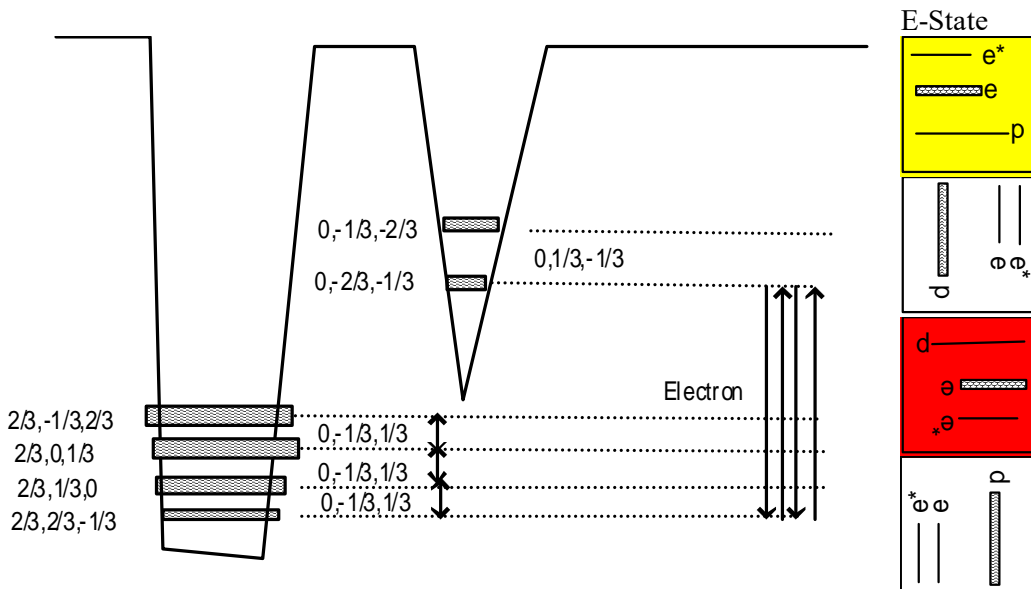

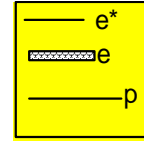

Where  $p=(2/3,2/3,-1/3)$ ,  $e=(0,-2/3,-1/3)$ ,  $e^*=(0,-1/3,-2/3)$  are a subset of states involved in the three most common “particles”= proton, electron and neutron. Below is another representation of the electron and positron. Notice that the first and last elements of the coherence chain are the same and that the coherence repeats itself for its lifetime. In the case of a proton/electron, that lifetime is infinite, since that coherence is between two ground states.

This is an effort to represent a tumbling 4D object which changes shape as it tumbles. Notice that the sidewise states have no 3D projection. Since in the theory, there is an absolute time, one can define an absolute phase and that is what distinguishes an electron from a positron. Later it will be clear that more complex coherences involving the  $e^*$  state (neutrino) will result in a phase shift of the tunneling process with respect to the tumbling process, thus modifying which state is in phase with the shock-wave universe.

The colors are shown only for states that have both a 3D projection and the same frequency as the fundamental dilator.

Another important element of the model is the bolden of the first axis length (e.g.  $p=(2/3,2/3,-1/3)$ ). This means that the spin is a tumbling process around and rotational axis perpendicular to both the radial direction (perpendicular to all three spatial coordinates and the x coordinate). This defines a 4D angular momentum which has to be conserved. More complex coherences like the ones associated with Delta and Sigma particles differs just by the final spin and thus by how the sub-coherences tumbles to make up the final amount of spinning.

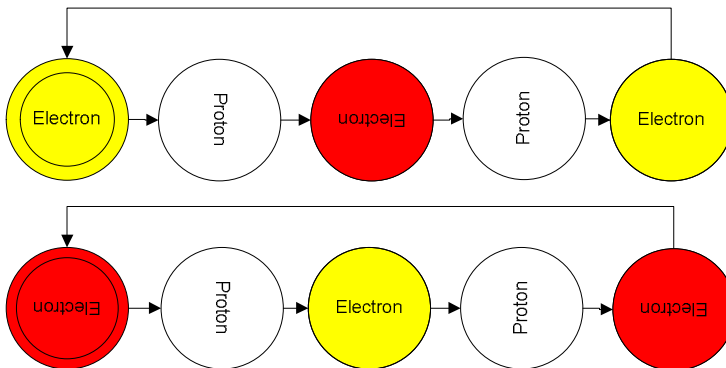

# Proton Model

Similarly for a proton:

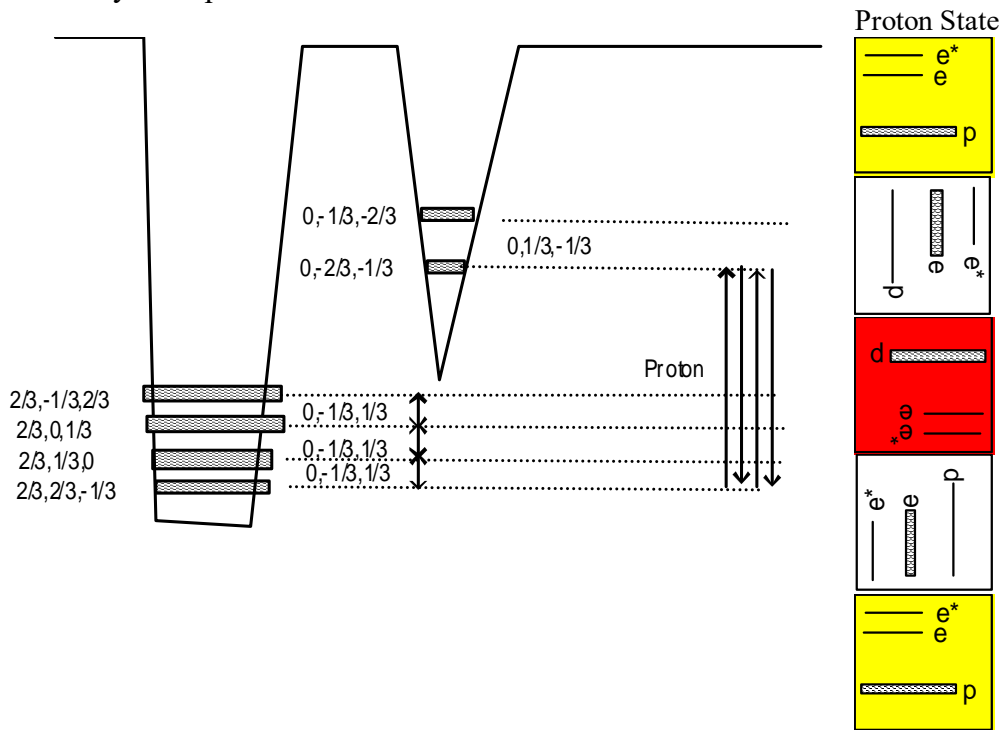

Here is the representation of a proton and an antiproton.

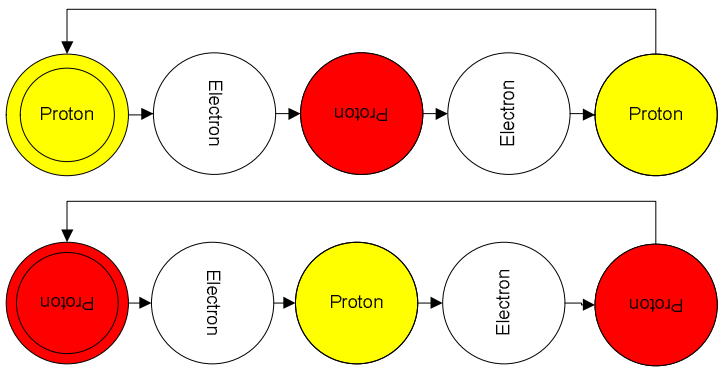

## NeutrinoElectron Model

Here is the electron neutrino model. Notice that there are no color associated with the neutrino states since they have zero 3D volume (they are 2D objects spinning around the a

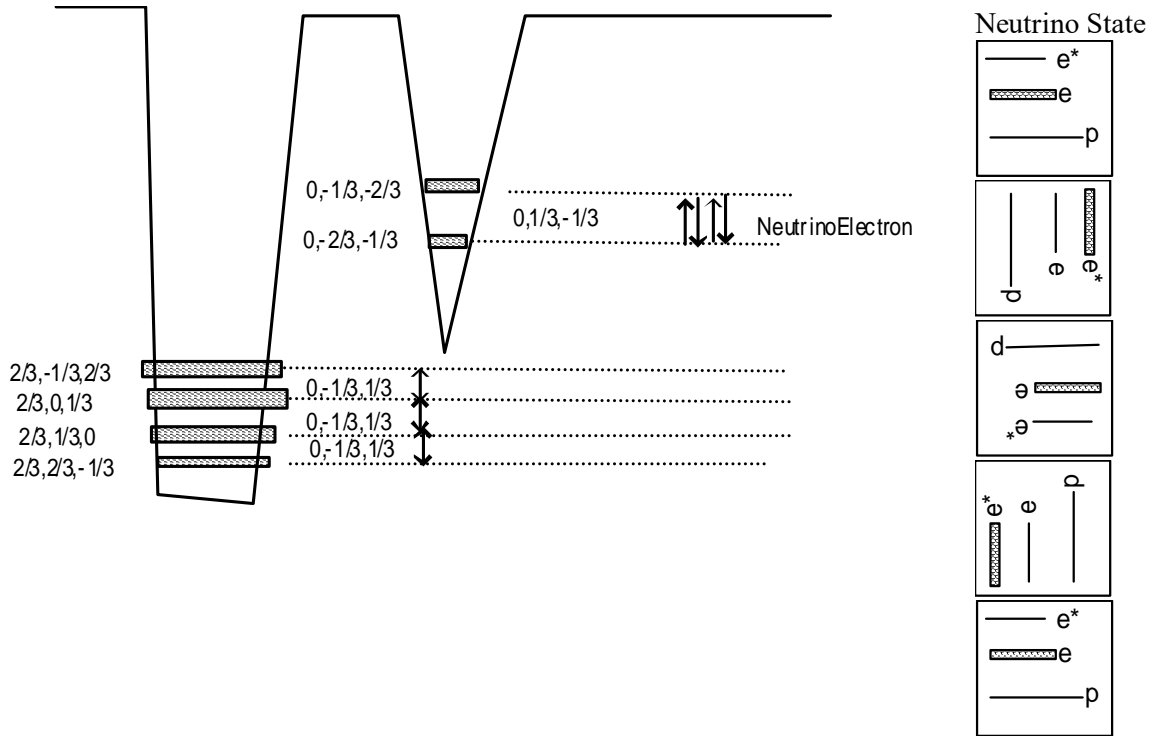

Where  $p=(2/3, 2/3, -1/3)$ ,  $p^*=(2/3, -1/3, 2/3)$ ,  $e=(0, -2/3, -1/3)$ ,  $e^*=(0, -1/3, -2/3)$

## Neutron Model

Below is the Neutron model. It is worthwhile to notice that the Electron-Proton and Proton-Electron transitions (transmutation coherences) are not in phase with the tumbling process and thus lead to a mismatch between the Neutron overall tumbling and a number of full rotations. This means that due to those sub-coherences, there is kinetic energy stored in the form of a local fabric of space twisting. The angle error at the end of the coherence is the sum of those two contributions. The electron and the proton coherences are by definition in phase with the tumbling process.

The shift in phase is such that the electron/proton fabric of space twisting is  $42.77/-0.07294$  degrees for a neutron at rest, respectively. This is the fabric of space twisting that would result in the observed relative velocities after neutron decaying. Notice that twisting the fabric of space results in an increase in the mass or 3D projection of the 4D volume displacement associated with different states, and thus explains the extra mass involved in the neutron formation. The same reasoning is applicable to all particles and elements. The elements and isotopes are modeled as simple coherences involving only the fundamental dilator (electron and proton) and these two transmutation coherences.

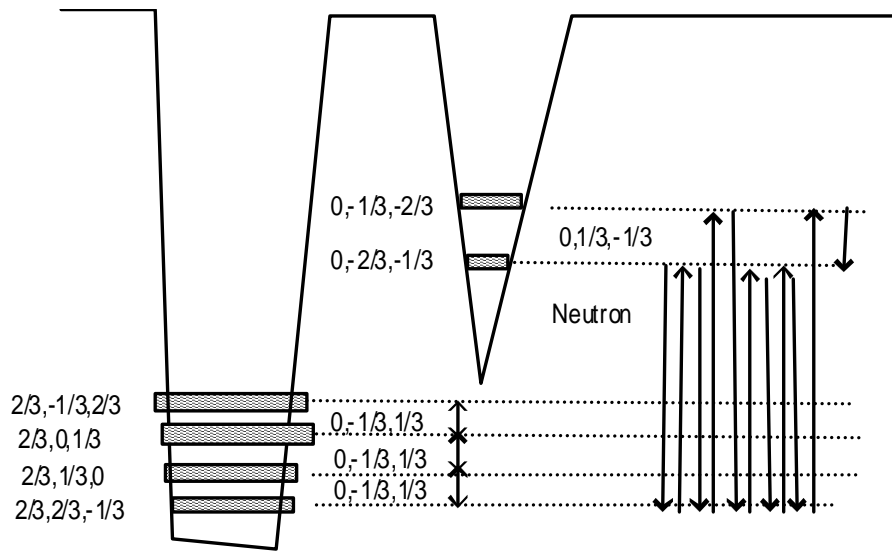

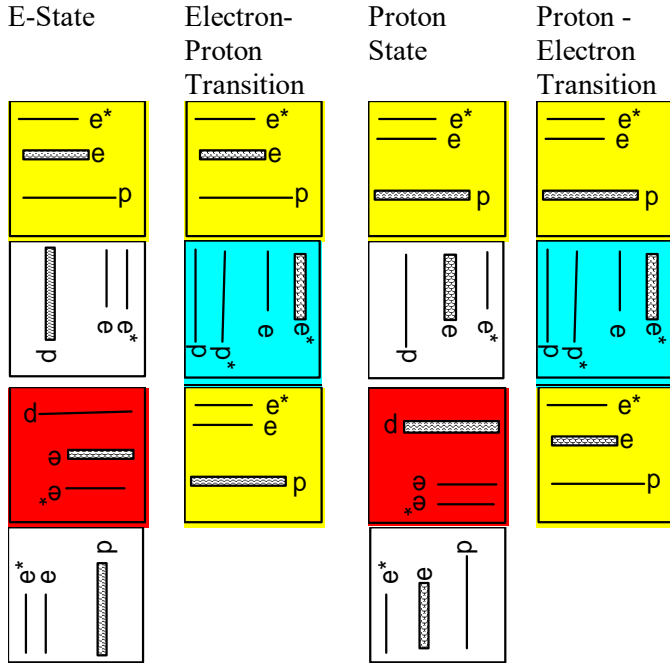

Where  $p=(2/3,2/3,-1/3)$ ,  $p^*=(2/3,-1/3,2/3)$ ,  $e=(0,-2/3,-1/3)$ ,  $e^*=(0,-1/3,-2/3)$ .

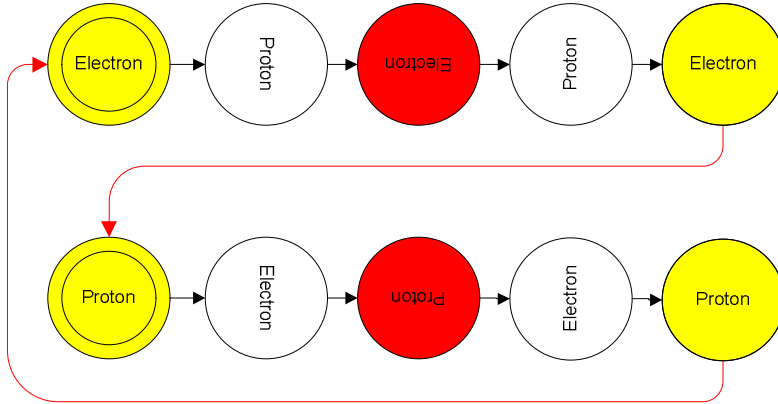

The extra energy or mass associated with the neutron is due to the dephasing created by the Electron-Proton Transition and vice-versa. The total angle is balanced between the two 3D footprints (electron and proton masses) to be  $42.77/-0.07294$  degrees, thus resulting in a dephasing angle by Electron-Proton Transmutation of around 21.4 degrees.

Thus the available kinetic energy after neutron decay is the difference in twisting between these two coherences.

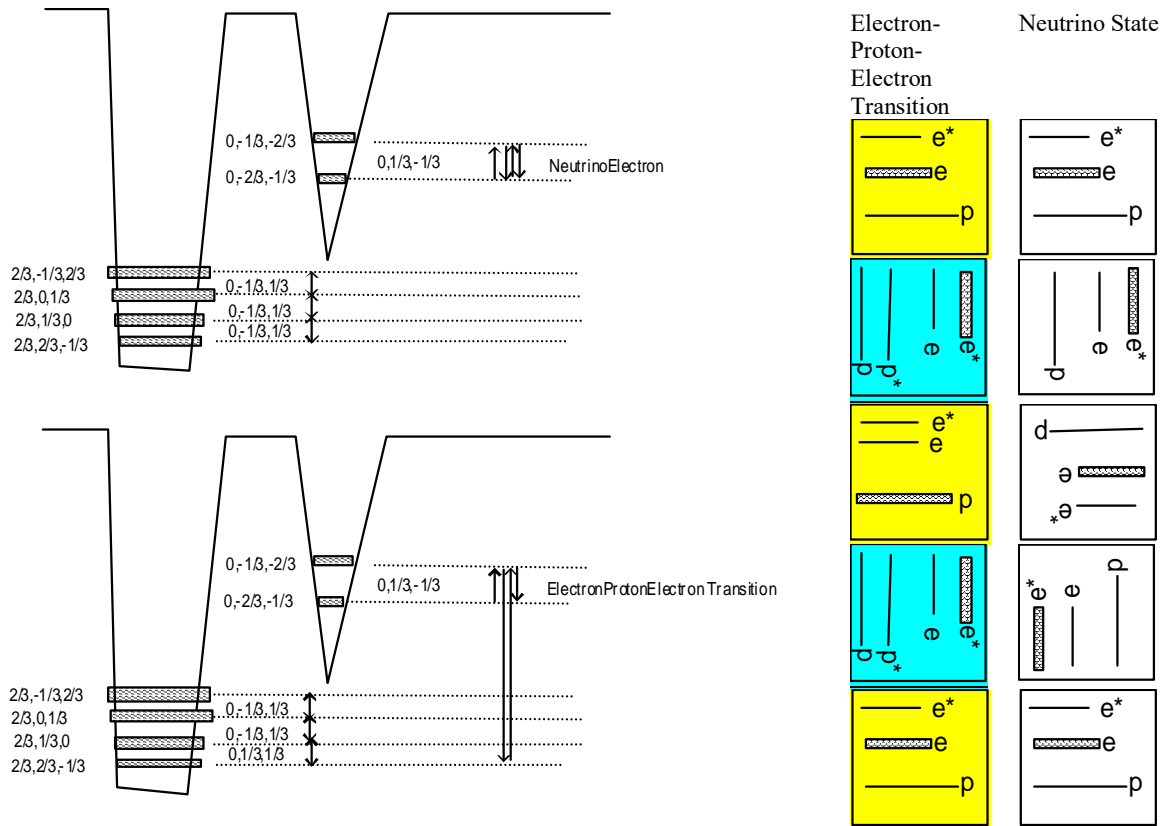

## Spin Differences between Hyperons

The hyperons<sup>(9)</sup> below differs only by the spinning direction of their sub-coherences<sup>(7)</sup>.

Hyperon Name	Symbol	Mass (MeV/c <sup>2</sup> )	Decay Process	Spin	Coherence Lifetime	Coherence Decomposition
DeltaPlus	$\Delta^+$	1232	$\pi^+ + n$	3/2	$6 \times 10^{-24}$	(0, 2/3, 1/3). (0, -1/3, 1/3). (2/3, 2/3, -1/3). (0, -2/3, -1/3). (0, -1/3, 1/3)
DeltaPlus	$\Delta^+$	1232	$\pi^0 + p$	3/2	$6 \times 10^{-24}$	(2/3, 2/3, -1/3) (0, 1/3, 2/3) . (0, -1/3, -2/3)
DeltaZero	$\Delta^0$	1232	$\pi^0 + n$	3/2	$6 \times 10^{-24}$	(2/3, 2/3, -1/3). (0, -2/3, -1/3). (0, -1/3, 1/3). (0, 1/3, 2/3) . (0, -1/3, -2/3)
DeltaZero	$\Delta^0$	1232	$\pi^- + p$	3/2	$6 \times 10^{-24}$	(0, -2/3, -1/3). (0, 1/3, -1/3). (2/3, 2/3, -1/3)
DeltaMinus	$\Delta^-$	1232	$\pi^- + n$	3/2	$6 \times 10^{-24}$	(0, -2/3, -1/3). (0, 1/3, -1/3). (2/3, 2/3, -1/3).
LambdaZero	$\Lambda^0$	1115.7	$\pi^- + p$	1/2	$2.60 \times 10^{-10}$	(0, -2/3, -1/3). (0, -1/3, 1/3)



LambdaZero	$\Lambda^0$	1115.7	$\pi^0 + n$	1/2	$2.60 \times 10^{-10}$	(0,1/3,-1/3). (2/3,2/3,-1/3) (0,1/3,2/3). (0,-1/3,-2/3). (2/3,2/3,-1/3). (0,-2/3,-1/3). (0,-1/3,1/3)
SigmaPlus	$\Sigma^+$	1189.4	$\pi^0 + p$	1/2	$0.8 \times 10^{-10}$	(2/3,2/3,-1/3). (0,1/3,2/3). (0,-1/3,-2/3)
SigmaPlus	$\Sigma^+$	1189.4	$\pi^+ + n$	1/2	$0.8 \times 10^{-10}$	(2/3,2/3,-1/3). (0,-2/3,-1/3). (0,-1/3,1/3). (0,2/3,1/3). (0,-1/3,1/3)

This means that in the case of  $\Delta^+$ , four sub-coherences are tumbling in one direction while the one left is tumbling in the opposite direction. Since each sub-coherence has spin half angular momentum, the resulting spin is 3/2.

In the case of the  $\Sigma^+$ , three sub-coherences tumble in one direction and two sub-coherences tumble on the opposite direction, resulting in spin 1/2. One expects that the amount of strain on the fabric of space will correlate with the coherence lifetime or life of the particle and thus that  $\Sigma^+$  would have a lower amount of accumulated dephasing with the fundamental dilator tumbling than  $\Delta^+$ .

Hyperon Name	Symbol	Mass (MeV/c <sup>2</sup> )	Decay Process	Spin	Coherence Lifetime	Coherence Decomposition
DeltaPlus	$\Delta^+$	1232	$\pi^+ + n$	3/2	$6 \times 10^{-24}$	(0,2/3,1/3). (0,-1/3,1/3). (2/3,2/3,-1/3). (0,-2/3,-1/3). (0,-1/3,1/3)
SigmaPlus	$\Sigma^+$	1189.4	$\pi^+ + n$	1/2	$0.8 \times 10^{-10}$	(2/3,2/3,-1/3). (0,-2/3,-1/3). (0,-1/3,1/3). (0,2/3,1/3). (0,-1/3,1/3)

## Appendix B- HU Corrections to Relativity

Let's consider velocity addition as a function of cosmological angle  $\theta$ .

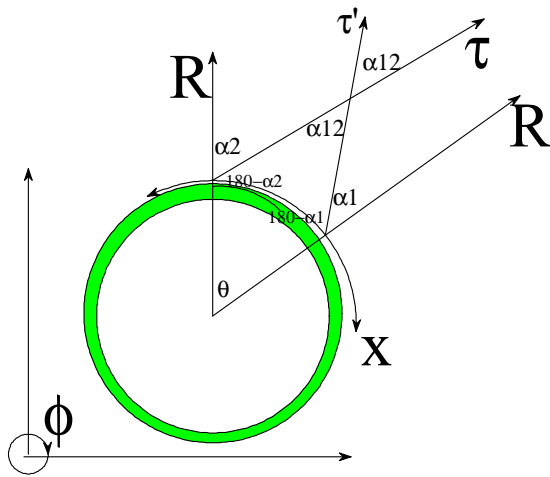

Figure B1. Hyperspherical Universe Model displaying two reference frames.

The two velocities are given by their angles with the Cosmological Radial direction. From simple trigonometry, one obtains:

$$\alpha_{12} + (180^\circ - \alpha_1) + (180^\circ - \alpha_2) + \theta = 360^\circ \text{ Or } \alpha_{12} = \alpha_1 + \alpha_2 - \theta$$

This means that when  $\theta = \alpha_1 + \alpha_2$  the two parties will never meet. There are two special case of interest:

- The two bodies are traveling at the speed of light ( $\alpha_1 = \alpha_2 = \pi/4$ ). Under those conditions  $\theta = \pi/2$ . This means that two traveling parties departing up to a cosmological angle  $\theta = \pi/2$ , can meet half-way if they travel at the speed of light.
- The other case is when one is deciding to explore some of the Universe and travel at the speed of light ( $\alpha_1 = \pi/4, \alpha_2 = 0$ ). This means that one can only explore one quarter of the Universe length in any direction.

- The correct relativistic velocity addition rule can be written as:

$$\tan(\alpha_{12}) = \frac{v_{12}}{c} = \tan(\alpha_1 + \alpha_2 - \theta) = \frac{\frac{\tan(\alpha_1) + \tan(\alpha_2)}{1 + \tan(\alpha_1)\tan(\alpha_2)} - \tan(\theta)}{1 - \frac{\tan(\alpha_1) + \tan(\alpha_2)}{1 + \tan(\alpha_1)\tan(\alpha_2)} \tan(\theta)}$$

Or

$$v_{12} = \frac{v_1 + v_2 - c \tan(\theta) \left(1 + \frac{v_1 v_2}{c^2}\right)}{1 + \frac{v_1 v_2}{c^2} - \frac{\tan(\theta)}{c} (v_1 + v_2)}$$

**Relativity fails for cosmological distances.** It is worth emphasizing that for  $\tan(\theta)=1$  ( $\theta=45^\circ$ ), independently upon the local velocities  $v_1$  and  $v_2$ , the perceived velocity  $v_{12}$  is always  $-c$ .

$$v_{12} = \frac{v_1 + v_2 - c \left(1 + \frac{v_1 v_2}{c^2}\right)}{1 + \frac{v_1 v_2}{c^2} - \frac{1}{c} (v_1 + v_2)} = -c$$

Thus for  $\theta=45^\circ$ , anything at that cosmological angle will be rushing away at the speed of light. Beyond that cosmological angle, relative time references and relative velocities are meaningless since there can not ever be communication or energy exchange between these two sites. There is a subtle difference between communication and travel and seeing the cosmological past, which has to do with the nature of light.

It is important to distinguish that the above derivation has to do with places one can travel or reach in terms of cosmological angles and not places one can see. One can see all the way to the beginning of times (with Doppler Shifted Vision – by upconverting the cosmic microwave background through fast traveling or other photonic means). The beginning of the Universe will always stare us in the eye, sitting at one radian or at the Beginning of Time. Gamma Radiation Doppler Shifted from the Big Bang is proposed to be the pervasive Cosmic Microwave Background.

## REFERENCES

- [1] Pereira, Marco – Hypergeometrical Universe – <http://Hypergeometricaluniverse.blogspot.com>
- [2] Homepage “Acoustics and Vibration Animations” -Dan Russell, Ph.D., Associate Professor of Applied Physics at Kettering University in Flint, MI <http://www.kettering.edu/~drussell/demos.html>
- [3] Schwarzschild, Bertram. "WMAP Spacecraft Maps the Entire Cosmic Microwave Sky With Unprecedented Precision.", Physics Today. Vol. 56, No. 4 (April 2003): 21.
- [4] Pauli W 1958 Theory of Relativity, London: Pergamon Press
- [5] Landau L D and Lifshitz E M 1975, The Classical Theory of Fields, Oxford: Pergamon Press.
- [6] Classical Electrodynamics – J.D. Jackson (1975-John Wiley & Sons).
- [7] Pereira, Marco - Hypergeometrical Standard Model, to be published elsewhere.
- [8] Pereira, Marco - Hypergeometrical Cosmogogenesis, to be published elsewhere.
- [9] Hyperon Polarization and Magnetic Moments, Joseph Lach – Fermilab-Conf-93/381

# Three Solar System Anomalies Indicating the Presence of Macroscopically Quantum Coherent Dark Matter in Solar System

M. Pitkänen

Dept. of Physics, University of Helsinki, Helsinki, Finland.

Email: [matpitka@rock.helsinki.fi](mailto:matpitka@rock.helsinki.fi).

<http://www.helsinki.fi/~matpitka/>.

## 1 Introduction

Three anomalies associated with the solar system, namely Pioneer anomaly [3], the evidence for shrinking of planetary orbits [7, 8, 9], and flyby anomaly [4] are discussed. The first anomaly is explained by a universal  $1/r$  distribution of dark matter, second anomaly finds a trivial explanation in TGD based quantum model for planetary orbits as Bohr orbits with Bohr quantization reflecting macroscopically quantum coherent character of dark matter with a gigantic value of Planck constant [11]. Fly-by anomaly can be understood if planetary orbits are surrounded by a flux tube containing quantum coherent dark matter. Also spherical shells can be considered.

## 2 Explanation of the Pioneer anomaly

The data gathered during one quarter of century ([2, 3]) seem to suggest that spacecrafts do not obey the laws of Newtonian gravitation. What has been observed is anomalous constant acceleration of order  $(8 \pm 3) \times 10^{-11}g$  ( $g = 9.81 \text{ m/s}^2$  is gravitational acceleration at the surface of Earth) for the Pioneer/10/11, Galileo and Ulysses [3]. The acceleration is directed towards Sun and could have an explanation in terms of  $1/r^2$  long range force if the density of charge carriers of the force has  $1/r$  dependence on distance from the Sun. From the data in [2, 3], the anomalous acceleration of the spacecraft is of order

$$\delta a \sim .8 \times 10^{-10} g \quad , \quad (1)$$

where  $g \simeq 9.81 \text{ m/s}^2$  is gravitational acceleration at the surface of Earth. Using the values of Jupiter distance  $R_J \simeq .8 \times 10^{12}$  meters, radius of Earth  $R_E \simeq 6 \times 10^6$  meters and the value Sun to Earth mass ratio  $M_S/M_E \simeq .3 * 10^6$ , one can relate the gravitational acceleration

$$a(R) = \frac{GM_S}{R^2} = \frac{M_S}{M_E} \frac{R_E^2}{R^2} \quad (2)$$

of the spacecraft at distance  $R = R_J$  from the Sun to  $g$ , getting roughly  $a \simeq 1.6 \times 10^{-5} g$ . One has also

$$\frac{\delta a}{a} \simeq 1.3 \times 10^{-4} \quad . \quad (3)$$

The value of the anomalous acceleration has been found to be  $a_F = (8.744 \pm 1.33) \times 10^{-8} \text{ cm/s}^2$  and given by Hubble constant:  $a_F = cH$ .  $H = 82 \text{ km/s/Mpc}$  gives  $a_F = 8 \times 10^{-8} \text{ cm/s}^2$ . It is very difficult to believe that this could be an accident. There are also diurnal and annual variations in the acceleration anomaly [4]. These variations should be due to the physics of Earth-Sun system. I do not know whether they can be understood in terms of a temporal variation of the Doppler shift due to the spinning and orbital motion of Earth with respect to Sun.

One model for the acceleration anomaly relies on the presence of dark matter increasing the effective solar mass. Since acceleration anomaly is constant, a dark matter density  $\rho_d = (3/4\pi)(H/Gr)$ , where  $H$  is Hubble constant giving  $M(r) \propto r^2$ , is required. For instance, at the radius  $R_J$  of Jupiter the dark mass would be about  $(\delta a/a)M(\text{Sun}) \simeq 1.3 \times 10^{-4} M(\text{Sun})$  and would become comparable to  $M_{\text{Sun}}$  at about  $100R_J = 520 \text{ AU}$ . Note that the standard theory for the formation of planetary system assumes a solar nebula of radius of order  $100 \text{ AU}$  having 2-3 solar masses. For Pluto at distance of  $38 \text{ AU}$  the dark mass would be about one per cent of solar mass. This model would suggest that planetary systems are formed around dark matter system with a universal mass density. The dependence of the primordial dark matter density on only Hubble constant is very natural if mass density perturbations are universal.

In [4] the possibility that the acceleration anomaly for Pioneer 10 (11) emerged only after the encounter with Jupiter (Saturn) is raised. The model

explaining Hubble constant as being due to a radial contraction compensating cosmic expansion would predict that the anomalous acceleration should be observed everywhere, not only outside Saturn. The model in which universal dark matter density produces the same effect would allow the required dark matter density  $\rho_d = (3/4\pi)(H/Gr)$  be present only as a primordial density. The formation of dark matter structures could have modified this primordial density and visible matter would have condensed around these structures so that only the region outside Jupiter would contain this density.

### 3 Shrinking radii of planetary orbits and Bohr quantization

There are two means of determining the positions of planets in the solar system [7, 8, 9, 10]. The first method is based on optical measurements and determines the position of planets with respect to the distant stars. Already thirty years ago [10] came the first indications that the planetary positions determined in this manner drift from their predicted values as if planets were in accelerated motion. The second method determines the relative positions of planets using radar ranging: this method does not reveal any such acceleration.

C. J. Masreliez [8] has proposed that this acceleration could be due to a gradual scaling of the planetary system so that the sizes  $L$  of the planetary orbits are reduced by an over-all scale factor  $L \rightarrow L/\lambda$ , which implies the acceleration  $\omega \rightarrow \lambda^{3/2}\omega$  in accordance with the Kepler's law  $\omega \propto 1/L^{3/2}$ . This scaling would exactly compensate the cosmological scaling  $L \rightarrow (R(t)/R_0) \times L$  of the solar system size  $L$ , where  $R(t)$  the curvature parameter of Robertson-Walker cosmology having the line element  $ds^2 = dt^2 - R^2(t) \left( \frac{dr^2}{1+r^2} + r^2 d\Omega^2 \right)$ .

According to Masreliez, the model explains also some other anomalies in the solar system, such as angular momentum discrepancy between the lunar motion and the spin-down of the Earth [8]. The model also changes the rate for the estimated drift of the Moon away from the Earth so that the Moon could have very well formed together with Earth some five billion years ago.

The Bohr quantization for planetary orbits predicts that the orbital radii measured in terms of  $M^4$  radial coordinate  $r_M$  are constant. This means that planetary system does not participate cosmic expansion so that the orbital radii expressed in terms of the coordinate  $r = r_M/a$  shrinking. Therefore the stars accelerate with respect to the Robertson-Walker coordinates  $(t, r, \Omega)$  defined by the distant stars since in this case the radii correspond naturally

to the coordinate  $r = r_M/a$  giving  $dr/dt = -Hr_M$  so that cosmic expansion is exactly compensated. This model for the anomaly involves no additional assumptions besides Bohr quantization and is favored by Occam's razor.

## 4 Fly-by anomaly

The so called flyby anomaly [4] might relate to the Pioneer anomaly. Fly-by mechanism used to accelerate space-crafts is a genuine three body effect involving Sun, planet, and the space-craft. Planets are rotating around sun in an anticlockwise manner and when the space-craft arrives from the right hand side, it is attracted by a planet and is deflected in an anticlockwise manner and planet gains energy as measured with respect to solar center of mass system. The energy originates from the rotational motion of the planet. If the space-craft arrives from the left, it loses energy. What happens is analyzed in [4] using an approximately conserved quantity known as Jacobi's integral  $J = \mathcal{E} - \omega \bar{e}_z \cdot \bar{r} \times \bar{v}$ . Here  $\mathcal{E}$  is total energy per mass for the space-craft,  $\omega$  is the angular velocity of the planet,  $\bar{e}_z$  is a unit vector normal to the planet's rotational plane, and various quantities are with respect to solar cm system.

This as such is not anomalous and flyby effect is used to accelerate space-crafts. For instance, Pioneer 11 was accelerated in the gravitational field of Jupiter to a more energetic elliptic orbit directed to Saturn and the encounter with Saturn led to a hyperbolic orbit leading out from solar system.

Consider now the anomaly. The energy of the space-craft in planet-space-craft cm system is predicted to be conserved in the encounter. Intuitively this seems obvious since the time and length scales of the collision are so short as compared to those associated with the interaction with Sun that the gravitational field of Sun does not vary appreciably in the collision region. Surprisingly, it turned out that this conservation law does not hold true in Earth flybys. Furthermore, irrespective of whether the total energy with respect to solar cm system increases or decreases, the energy in cm system increases during flyby in the cases considered.

Five Earth flybys have been studied: Galileo-I, NEAR, Rosetta, Cassina, and Messenger and the article of Anderson and collaborators [4] gives a nice quantitative summary of the findings and of the basic theoretical notions. Among other things the tables of the article give the deviation  $\delta\mathcal{E}_{g,s}$  of the energy gain per mass in the solar cm system from the predicted gain. The anomalous energy gain in rest Earth cm system is  $\Delta\mathcal{E}_E \simeq \bar{v} \cdot \Delta\bar{v}$  and allows to deduce the change in velocity. The general order of magnitude is

$\Delta v/v \simeq 10^{-6}$  for Galileo-I, NEAR and Rosetta but consistent with zero for Cassini and Messenger. For instance, for Galileo I one has  $v_{\infty,S} = 8.949$  km/s and  $\Delta v_{\infty,S} = 3.92 \pm .08$  mm/s in solar cm system.

Many explanations for the effect can be imagined but dark matter is the most obvious candidate in TGD framework. The model for the Bohr quantization of planetary orbits assumes that planets are concentrations of the visible matter around dark matter structures. These structures could be tubular structures around the orbit or a nearly spherical shell containing the orbit. The contribution of the dark matter to the gravitational potential increases the effective solar mass  $M_{eff,S}$ . This of course cannot explain the acceleration anomaly which has constant value.

For instance, if the space-craft traverses shell structure, its kinetic energy per mass in Earth cm system changes by a constant amount not depending on the mass of the space-craft:

$$\frac{\Delta E}{m} \simeq v_{\infty,E} \Delta v = \Delta V_{gr} = \frac{G \Delta M_{eff,S}}{R} . \quad (4)$$

Here  $R$  is the outer radius of the shell and  $v_{\infty,E}$  is the magnitude of asymptotic velocity in Earth cm system. This very simple prediction should be testable. If the space-craft arrives from the direction of Sun the energy increases. If the space-craft returns back to the sunny side, the net anomalous energy gain vanishes. This has been observed in the case of Pioneer 11 encounter with Jupiter [4].

The mechanism would make it possible to deduce the total dark mass of, say, spherical shell of dark matter. One has

$$\begin{aligned} \frac{\Delta M}{M_S} &\simeq \frac{\Delta v}{v_{\infty,E}} \frac{2K}{V} , \\ K &= \frac{v_{\infty,E}^2}{2} , \quad V = \frac{GM_S}{R} . \end{aligned} \quad (5)$$

For the case considered  $\Delta M/M_S \geq 2 \times 10^{-6}$  is obtained. One might consider the possibility that the primordial dark matter has concentrated in spherical shells in the case of inner planets as indeed suggested by the model for quantization of radii of planetary orbits. Note that the amount of dark mass within sphere of 1 AU implied by the explanation of Pioneer anomaly would be about  $6.2 \times 10^{-6} M_S$  from Pioneer anomaly whereas the mass of Earth is  $M_E \simeq 5 \times 10^{-6} M_S$ . Since the orders of magnitude are same, one might consider the possibility that the primordial dark matter has concentrated



in spherical shells in the case of inner planets as indeed suggested by the model for quantization of radii of planetary orbits. Of course, the total mass associated with  $1/r$  density quite too small to explain entire mass of the solar system.

In the solar cm system the energy gain is not constant. Denote by  $\bar{v}_{i,E}$  and  $\bar{v}_{f,E}$  the initial and final velocities of the space-craft in Earth cm. Let  $\Delta\bar{v}$  be the anomalous change of velocity in the encounter and denote by  $\theta$  the angle between the asymptotic final velocity  $\bar{v}_{f,S}$  of planet in solar cm. One obtains for the corrected  $\mathcal{E}_{g,S}$  the expression

$$\mathcal{E}_{g,S} = \frac{1}{2} \left[ (\bar{v}_{f,E} + \bar{v}_P + \Delta\bar{v})^2 - (\bar{v}_{i,E} + \bar{v}_P)^2 \right] . \quad (6)$$

This gives for the change  $\delta\mathcal{E}_{g,S}$

$$\begin{aligned} \delta\mathcal{E}_{g,S} &\simeq (\bar{v}_{f,E} + \bar{v}_P) \cdot \Delta\bar{v} \simeq v_{f,S} \Delta v \times \cos(\theta_S) \\ &= v_{\infty,S} \Delta v \times \cos(\theta_S) . \end{aligned} \quad (7)$$

Here  $v_{\infty,S}$  is the asymptotic velocity in solar cm system and in excellent approximation predicted by the theory.

Using spherical shell as a model for dark matter one can write this as

$$\delta\mathcal{E}_{g,S} = \frac{v_{\infty,S}}{v_{\infty,E}} \frac{G\Delta M}{R} \cos(\theta_S) . \quad (8)$$

The proportionality of  $\delta\mathcal{E}_{g,S}$  to  $\cos(\theta_S)$  should explain the variation of the anomalous energy gain.

For a spherical shell  $\Delta\bar{v}$  is in the first approximation orthogonal to  $v_P$  since it is produced by a radial acceleration so that one has in good approximation

$$\begin{aligned} \delta\mathcal{E}_{g,S} &\simeq \bar{v}_{f,S} \cdot \Delta\bar{v} \simeq \bar{v}_{f,E} \cdot \Delta\bar{v} \simeq v_{f,S} \Delta v \times \cos(\theta_S) \\ &= v_{\infty,E} \Delta v \times \cos(\theta_E) . \end{aligned} \quad (9)$$

For Cassini and Messenger  $\cos(\theta_S)$  should be rather near to zero so that  $v_{\infty,E}$  and  $v_{\infty,S}$  should be nearly orthogonal to the radial vector from Sun in these cases. This provides a clear cut qualitative test for the spherical shell model.

## References

- [1] M. Pitkänen (2006), *Physics in Many-Sheeted Space-Time*.  
<http://www.helsinki.fi/~matpitka/tgdclass/tgdclass.html>.
- [2] C. Seife in *New Scientist*, No 2151, Sept. 12, 1998, p. 4.
- [3] J. D. Anderson *et al* (1998), *Phys. Rev.Lett.* Vol. 81, No 14,p. 2858.
- [4] J. D. Anderson *et al* (2006), *The energy Transfer Process in Planetary Flybys*, astro-ph/0608087.
- [5] D. Da Roacha and L. Nottale (2003), *Gravitational Structure Formation in Scale Relativity*, astro-ph/0310036.
- [6] A. Rubric and J. Rubric (1998), *The Quantization of the Solar-like Gravitational Systems*, *Fizika B7*, 1, 1-13.  
Idid (1999), *Square Law for Orbits in Extra-solar Planetary Systems*, *Fizika A* 8, 2, 45-50.
- [7] C. J. Masreliez (2001), *Do the planets accelerate*.  
<http://www.estfound.org>.
- [8] C. J. Masreliez (2001), *Expanding Space-Time Theory*,  
<http://www.estfound.org>.
- [9] Y. B. Kolesnik (2000), *Applied Historical Astronomy, 24th meeting of the IAU*, Joint Discussion 6, Manchester, England.  
*Ibid* (2001a), *Journees 2000 Systemes de reference spatio-temporels*, J2000, a fundamental epoch for origins of reference systems and astronomical models, Paris.
- [10] C. Oesterwinter and C. J. Cohen (1972), *Cel. Mech.* 5, 317.
- [11] The chapter *TGD and Astrophysics* of [1].  
<http://www.helsinki.fi/~matpitka/tgdclass/tgdclass.html#astro>.

## RELATIVISTIC OSCILLATOR IN QUATERNION RELATIVITY

A.P. Yefremov  
Institute of Gravitation and Cosmology,  
Peoples Friendship University of Russia  
Moscow, Russia.  
E-mail: [a.yefremov@rudn.ru](mailto:a.yefremov@rudn.ru)  
[www.rudn.ru](http://www.rudn.ru)

### Abstract

In the framework of Quaternion (Q-) Theory of Relativity implying invariance of the 6D-space-time vector “interval” the kinematics of two frames is considered under condition that one frame is inertial and the other is subject to action of harmonic force. Using mathematical tools of Q-relativity the cinematic problem is completely solved from the viewpoint of each frame, i.e. distance, velocity and acceleration are found as functions of observers’ time. Majority of cinematic relations are revealed to be represented by exact expressions: elementary functions and series; some relations though are found only approximately. Observed motions are of course not harmonic functions. Clock paradox is discussed.

### I. Introduction: Q-relativity in short

There are many types of physics theories based on more than three space-time dimensions, but the only one, Einstein-Minkowski 4D theory, has comprehensive reasons for number of its dimensions. All others, beginning from 5D Kaluza-Klien theory up to 21D supergravity or to 2nD Calabi-Yau string theory spaces, are heuristically postulated. It is worth mentioning that several attempts to build “symmetric” 6D-relativities (3D-space + 3D-time) were made by Cole, Starr, Pavshic, Recami and others (see e.g. [1] and ref. therein). But the symmetry introduced also “ad hoc” together with abelian character of multiplication inherited from Ein-

stein's relativity lead in these theories to a series of interpretational difficulties.

Differently from these patterns 6D-theory of Q-relativity (or Rotational Relativity) suggested in 1996 [2,3] does not result from phenomenological considerations but is extracted from quaternion mathematics as its modest but quite natural part. The extraction goes through following six steps. First, basic multiplication rule for Q-numbers is discovered to be form-invariant under Q-units transformations composing rotational group  $SO(3,C)$ . Second, and this was pointed out by W.Hamilton, three "imaginary" Q-units, behave exactly as a Cartesian vector triad. Fourth, it is shown that real rotations from  $SO(3,C)$  save form of Q-vector (with real components) defined in a Q-triad. Fifth, similar form-invariance property is observed for biquaternionic (BQ) vectors under mixed real-imaginary rotations reducing the initial group to  $SO(1,2)$ ; this distinguishes the set of BQ-vectors with definable norm. All these facts have purely mathematical nature with no evident relevance to physics. But knowledge that  $SO(3,C)$  and its subgroup  $SO(1,2)$  are closely related to Lorents group hints to make the sixth "physical" step: the BQ-vector components are taken for space and time "displacements", space-time acquires 3+3-symmetric geometry, and the basic BQ-vector turns out nothing else but a specific 6D Q-square root of the interval of Einstein's relativity. Since no limitations are found for rotation parameters one is free to operate with inertial as well with non-inertial Q-frames.

So, Q-Relativity exploits the fact of  $SO(1,2)$ -invariance of 6D-space-time biquaternionic vector "interval"

$$dz = (idt_k + dx_k) \mathbf{q}_k$$

with definable real norm

$$dz^2 = dt^2 - dx^2 .$$

If a Q-frame composed of "imaginary" vector Q-units

$$\Sigma' \equiv \mathbf{q}_{k'} = \{\mathbf{q}_{1'}, \mathbf{q}_{2'}, \mathbf{q}_{3'}\}^*$$

is observed from another analogous Q-frame  $\Sigma$ , then the  $dz$ -invariance results in a simple relation for time and space “displacement” vectors

$$idt' \mathbf{q}_{1'} = idt \mathbf{q}_1 + dx \mathbf{q}_2,$$

vectors  $d\mathbf{t}$  and  $d\mathbf{r}$  obviously orthogonal to each other. The last condition naturally distinguishes scalar time out of 6-dimensionality, and allows regarding physical situations. The Q-frames may depend in general on 6 real parameters representing spatial rotations and boosts; in their turn the parameters are not banned to be variable e.g. dependent on time of observers hiding at the origins of the frames which are in this case non-inertial but nevertheless well described in the Q-approach. Technological tool of the theory is a Rotational Equation (RE) of the type

$$\Sigma' = O \Sigma$$

where  $O$  is a combination of real  $R$  and hyperbolic  $H$  rotations from  $SO(1,2)$  “converting” the frame of the observer  $\Sigma$  into the observed frame  $\Sigma'$ . From the RE cinematic effects of Q-frames relative motion are easily calculated, among them all effects of Einstein’s Special Relativity and a number of non-inertial motion effects, e.g. hyperbolic motion and Thomas precession [4].

The Q-relativity also represents a good mean to study non-inertial clock behavior once largely discussed [5]. A desirable model to illustrate the problem is a “fast” linear harmonic oscillator. In Sect.2 definition of a relativistic harmonic oscillator is given and full cinematic problem is solved from the viewpoint of inertial and oscillating observers. Sect.3 is devoted to discussion of twin paradox issues associated with the solution.

---

\* The multiplication rule for Q-units is  $\mathbf{q}_k \mathbf{q}_n = -\delta_{kn} + \varepsilon_{knj} \mathbf{q}_j$  where  $\delta_{kn}$ ,  $\varepsilon_{knj}$  are Kroneker and Levi-Civita 3D symbols, summation convention is assumed.

## II. Linear harmonic oscillator problem in Q-relativity

Mathematical tool of Q-relativity allows studying behavior of non-inertially moving clock. A natural model of such a clock is a harmonic oscillator, “spring pendulum”, arranged so that initial and final positions of its «massive body» (too, a body of reference of non-inertial harmonically moving observer) precisely coincide with position of immobile inertial observer, and relative velocity of the two observers at these moments is zero.

Let  $\Sigma$  be inertial frame and  $\Sigma'$  represent non-inertial frame whose body of reference is subject to action of a periodical harmonic force along a straight line. Since kinematics of the system is the focus of this study nature of the force here is of no importance.

### CASE A. $\Sigma'$ IS OBSERVED FROM $\Sigma$

If inertial frame  $\Sigma$  is modeled by a constant Q-triad  $\mathbf{q}_k$  whose vector  $\mathbf{q}_2$  is aligned with frames relative velocity, then rotational equation interconnecting two frames in question has the form

$$\Sigma' = H_3^{\psi(t')} \Sigma \quad (1)$$

with  $H_3^{\psi(t')}$  being  $3 \times 3$ -matrix of simple hyperbolic rotation (about axis parallel to  $\mathbf{q}_3$ ) and variable parameter  $\psi(t')$  depending on time of moving observer

$$H_3^{\psi} = \begin{pmatrix} \cosh \psi & -i \sinh \psi & 0 \\ i \sinh \psi & \cosh \psi & 0 \\ 0 & 0 & 1 \end{pmatrix}.$$

The first row of Eq.1

$$\mathbf{q}_{1'} = \cosh \psi \mathbf{q}_1 - i \sinh \psi \mathbf{q}_2,$$

under standard conditions

$$\cosh \psi = \frac{dt'}{dt}, \quad (2)$$

$$V = \tanh \psi \quad (3)$$

is equivalent to biquaternionic vector basic in Q-theory of relativity (fundamental velocity equals unity:  $c = 1$ )

$$dz = idt' \mathbf{q}_{1'} = idt \mathbf{q}_1 + dx \mathbf{q}_2 \quad (4)$$

so that  $\Sigma$ -time and  $\Sigma'$ -time are aligned respectively with  $\mathbf{q}_1$ , and  $\mathbf{q}_{1'}$ . Eq.4 yields main cinematic vector characteristics, i.e. for  $\Sigma'$ -observer one readily finds relative Q-vector velocity

$$\mathbf{v}' \equiv \frac{dz}{idt'} = \mathbf{q}_{1'}$$

and Q-vector acceleration

$$\mathbf{a}' \equiv \frac{d\mathbf{v}'}{idt'} = \frac{d\mathbf{q}_{1'}}{idt'} = -i\omega_{1'2'} \mathbf{q}_{2'} \equiv a' \mathbf{q}_{2'}. \quad (5)$$

where the only non-vanishing component of Q-connection [3]

$$\omega_{1'2'} = i \frac{d\psi}{dt'}$$

is computed as

$$\omega' = \frac{dH}{dt'} H^{-1}.$$

Thus value of Q-acceleration (5) aligned with  $\mathbf{q}_{2'}$  is simply expressed through velocity parameter

$$a'(\Sigma') = \frac{d\psi}{dt'}.$$

It is natural to attribute to Q-frame a type of motion corresponding to the type of acceleration “felt” by observer in this frame. Well known example is the hyperbolic motion where non-inertial observer subject to constant acceleration feels constant force acting on him [6]. Similarly motion of  $\Sigma'$  is represented as harmonic one

if  $\Sigma'$ -acceleration, force per unit mass, obeys harmonic, e.g. cosine, law measured in its own time\*\*

$$a'(\Sigma') = \frac{d\psi}{dt'} = \Omega' \beta \cos \Omega' t' ; \quad (6)$$

here  $\beta$  is a real constant (amplitude is chosen in this form for future commodity reasons), acceleration is maximal for  $t' = 0$ . Integration of Eq.6 gives dependence of hyperbolic parameter on proper  $\Sigma'$ -time

$$\psi(t') = \beta \sin \Omega' t' . \quad (7)$$

Constant of integration, initial phase, is chosen zero so that at the beginning and the end of oscillation period relative velocity vanish. It is worth noting here that the hyperbolic parameter, not velocity itself, has to be a harmonic function.

#### $\Sigma'(\Sigma)$ time ratio

Now complete cinematic problem for the regarded mechanical system can be solved, i.e. coordinate, velocity and acceleration of  $\Sigma'$  are to be found as functions of  $\Sigma$ -observer's time. But preliminary integration of the time-correlation equation resulting from Eq.2

$$dt' = dt \cosh \psi(t') ,$$

is necessary to determine  $\Sigma'$ - $\Sigma$  observers' times interdependence

$$t = \int \cosh \psi(t') dt' = \int \cosh(\beta \sin \Omega' t') dt' . \quad (8)$$

An easy analysis shows that the integral can be computed exactly, not in elementary functions but as series. First, one applies well-known development of hyperbolic cosine

$$\cosh u = 1 + \sum_{n=1}^{\infty} \frac{1}{(2n)!} u^{2n} , \quad |u| < \infty ,$$

---

\*\* Phase of the oscillation is chosen so that at initial and final moments of oscillation period velocity vanishes.



last condition being always fulfilled since  $u \equiv \beta \sin \Omega' t' < \infty$ . Second, one uses the following table integral

$$\int \sin^{2n} y \, dy = \frac{1}{2^{2n}} \binom{2n}{n} y + \frac{(-1)^n}{2^{2n-1}} \sum_{k=0}^n (-1)^k \binom{2n}{k} \frac{\sin(2n-2k)y}{2n-2k}. \quad (9)$$

And third, the substitution  $y \equiv \Omega' t'$  in Eq.9 gives the sought for result of integration in Eq.8

$$t = t' + \sum_{n=1}^{\infty} \frac{\beta^{2n}}{(2n)!} \left[ \frac{1}{2^{2n}} \binom{2n}{n} t' + \frac{(-1)^n}{2^{2n-1}} \sum_{k=0}^{n-1} (-1)^k \binom{2n}{k} \frac{\sin(2n-2k)\Omega' t'}{(2n-2k)\Omega'} \right]. \quad (10)$$

This result compels to recall that obtaining exact solutions in framework of relativity theory is a remarkable feature of simple and correctly formulated physical problems such as hyperbolic or circular motion. The relativistic oscillator problem seems to belong to the distinguished set.

One oscillation is completed when  $\Omega' T' = 2\pi$ ,  $T'$  being oscillation period measured in  $\Sigma'$ . Corresponding  $\Sigma$ -time interval, “period”  $T$ , is straightforwardly found from Eq.10

$$T = T' \left( 1 + \sum_{n=1}^{\infty} \frac{\beta^{2n}}{(2n)!} \frac{1}{2^{2n}} \binom{2n}{n} \right), \quad (11)$$

as well as respective cycle frequencies ratio

$$\Omega' = \Omega \left( 1 + \sum_{n=1}^{\infty} \frac{\beta^{2n}}{(2n)!} \frac{1}{2^{2n}} \binom{2n}{n} \right). \quad (12)$$

Eq.12 tells that  $\Sigma$ -observed periodic motion possesses less frequency than oscillations felt by  $\Sigma'$ -observer; the fact sounds conventionally in relativity: moving clock is apparently slow.

Inversion of Eq.10 is evidently hardly possible, so expression of  $\Sigma'$ -time as a function of  $\Sigma$ -time  $t'(t)$  is looked for in approximation. First several terms of series in Eq.10 are written as

$$\begin{aligned}
t = t' + \frac{\beta^2}{4} \left( t' - \frac{1}{2\Omega'} \sin 2\Omega' t' \right) + \\
+ \frac{\beta^4}{8 \cdot 4!} \left[ 3t' - \frac{1}{\Omega'} \left( \frac{1}{4} \sin 4\Omega' t' - 2 \sin 2\Omega' t' \right) \right] + \dots
\end{aligned} \tag{10a}$$

Dimensionless factor  $\beta$  may be given in the form

$$\beta = V_0 / c \ll 1,$$

where  $V_0$  can be any characteristic value of relative velocity, e.g. mean value for  $\frac{1}{2}$  of period. Then the following ratios connecting frequencies and times are written up to the terms including  $\beta^2$

$$\Omega = \frac{\Omega'}{1 + \beta^2 / 4}, \tag{13a}$$

$$t' = t - \frac{\beta^2}{4} \left( t - \frac{1}{2\Omega} \sin 2\Omega t \right). \tag{13b}$$

Substitution of Eqs.13 into expression for velocity parameter (Eq.3) allows to find approximate solution of the cinematic problem for  $\Sigma$ -observer.

#### $\Sigma'(\Sigma)$ Velocity

Velocity value of the frame  $\Sigma'$  observed from  $\Sigma$  is (fundamental velocity  $c$  is explicitly shown)

$$V(t) = c \tanh(\beta \sin \Omega' t') \cong V_0 \sin \Omega t \left( 1 - \frac{1}{3} \beta^2 + \frac{7}{12} \beta^2 \cos^2 \Omega t \right).$$

At the beginning and at the end of period velocity acquires minimal value  $V(T) = 0$ , i.e. at these moments the two frames are really immobile relative to each other. Maximal value of the velocity

$$V(T/4) = V_0 \left( 1 - \frac{1}{3} \beta^2 \right)$$

may be regarded as “V-amplitude”

$$\tilde{V} = V_0 \left( 1 - \frac{1}{3} \beta^2 \right),$$

and final expression has the form

$$V(t) \cong \tilde{V} \sin \Omega t \left( 1 + \frac{7}{12} \beta^2 \cos^2 \Omega t \right) \quad (14)$$

meaning that the periodic process observed from  $\Sigma$  definitely has no harmonic character.

#### $\Sigma'(\Sigma)$ Acceleration

Value of  $\Sigma$ -observed acceleration of  $\Sigma'$  is found as

$$a(t) = \frac{dV(t)}{dt} \cong \Omega \tilde{V} \cos \Omega t \left( 1 - \frac{7}{6} \beta^2 + \frac{7}{4} \beta^2 \cos^2 \Omega t \right).$$

Minimal value acceleration acquires at the middle of period

$$a(T/4) = 0,$$

and maximal value, “ $a$ -amplitude”, at its end

$$a(T) = \Omega \tilde{V} \left( 1 - \frac{7}{12} \beta^2 \right) = \tilde{A};$$

the final expression is

$$a(t) \cong \tilde{A} \cos \Omega t \left( 1 - \frac{7}{4} \beta^2 \sin^2 \Omega t \right). \quad (15)$$

#### $\Sigma'(\Sigma)$ Coordinate

$\Sigma$ -coordinate of  $\Sigma'$  is computed as result of integration

$$x(t) = \int V(t) dt \cong x_0 - \frac{\tilde{V}}{\Omega} \cos \Omega t \left( 1 + \frac{7}{36} \beta^2 \cos^2 \Omega t \right), \quad (16)$$

the integration constant

$$x_0 = \frac{\tilde{V}}{\Omega} \left( 1 + \frac{7}{36} \beta^2 \right)$$

is chosen to satisfy the following initial conditions

$$x(0) = x(T) = 0, \quad x(T/4) = x_0, \quad x(T/2) = 2x_0,$$

meaning, that at the initial and final moments of period the two frames are not only relatively immobile but too are found at the same point in space.

Thus the  $\Sigma'(\Sigma)$ -cinematic problem is solved in approximation  $\beta \ll 1$ ; the result is given in Eqs.10, 14, 15, 16.

#### CASE B. $\Sigma$ IS OBSERVED FROM $\Sigma'$

Rotational equation for this case

$$\Sigma = H_3^{-\psi(t')} \Sigma', \quad (17)$$

has the same parameter

$$\psi(t') = \beta \sin \Omega t'$$

describing harmonic oscillations of  $\Sigma'$ . The first row of Eq.17 represent space-time vector “interval”

$$idt \mathbf{q}_1 = idt' \mathbf{q}_{1'} - dx' \mathbf{q}_{2'} \quad (18)$$

where  $dx'$  is space displacement of  $\Sigma$  and  $dt'$  is respective time interval, both measured by non-inertially moving  $\Sigma'$ -observer. Calculated from Eq.18 proper Q-vector acceleration of  $\Sigma$  is naturally zero

$$\mathbf{a} \equiv \frac{d\mathbf{q}_1}{idt} = 0,$$

so study of this case considers cinematic magnitudes only as they are seen from genuinely accelerated frame  $\Sigma'$ .

#### $\Sigma$ ( $\Sigma'$ )-time ratio

Following from Eq.18 standard relativistic expression

$$dt' = dt \cosh \psi(t')$$

leads to integral determining  $t(t')$  functional dependence

$$t = \int \frac{dt'}{\cosh \psi(t')} = \int \operatorname{sech}(\beta \sin \Omega' t') dt'. \quad (19)$$

This integration also can be performed exactly due to existence of development

$$\operatorname{sech} u = 1 + \sum_{n=1}^{\infty} (-1)^n \frac{E_n}{(2n)!} u^{2n}, \quad |u| < \pi/2 \quad (20)$$

and table integral already used in the Case A and given by Eq.9. Series in Eq.20 includes Euler numbers

$$E_n \equiv \frac{2^{2n+2} (2n)!}{\pi^{2n+1}} \sum_{k=1}^{\infty} \frac{(-1)^{k-1}}{(2k-1)^{2n+1}},$$

and its convergence condition

$$|u| \equiv |\beta \sin \Omega' t'| < \pi/2,$$

is always satisfied since

$$\beta = V_0/c < 1, \quad \sin \Omega' t' < 1.$$

Resulting formula of integration in Eq.20 has the form

$$t = t' + \sum_{n=1}^{\infty} \frac{(-1)^n E_n \beta^{2n}}{(2n)!} \left[ \frac{1}{2^{2n}} \binom{2n}{n} t'^n + \frac{(-1)^n}{2^{2n-1}} \sum_{k=0}^{n-1} (-1)^k \binom{2n}{k} \frac{\sin(2n-2k)\Omega' t'}{(2n-2k)\Omega'} \right]. \quad (21)$$

Eq.21 permits to  $\Sigma'$ -observer to measure real period of  $T'$  and cycle frequency  $\Omega'$  and also to calculate similar characteristics  $T$ ,  $\Omega$  theoretically attributed to the frame  $\Sigma$  and to find respective correlations

$$T = T' \left( 1 + \sum_{n=1}^{\infty} \frac{(-1)^n E_n \beta^{2n}}{(2n)! 2^{2n}} \binom{2n}{n} \right), \quad (22)$$

$$\Omega' = \Omega \left( 1 + \sum_{n=1}^{\infty} \frac{(-1)^n E_n \beta^{2n}}{(2n)! 2^{2n}} \binom{2n}{n} \right) \quad (23)$$

of course different from analogous Eqs.11, 12 of the Case A due to different inertiality properties of the observers. But computing frequency ratio in Eq.23 up to first approximation in  $\beta^2$

$$\Omega' \cong \Omega \left( 1 + \frac{-E_1 \beta^2}{2 \cdot 2!} \binom{2}{1} \right),$$

where

$$E_1 = \frac{2^5}{\pi^3} \left( 1 - \frac{1}{3^3} + \frac{1}{5^3} - \frac{1}{7^3} + \frac{1}{9^3} - \dots \right) \cong 1,$$

gives result similar to Case A analog Eq.13a

$$\Omega' \cong \Omega \left( 1 - \frac{\beta^2}{4} \right), \quad (24)$$

i.e.  $\Sigma'$ -frequency, normally for relativity, is smaller than that of  $\Sigma$  from the viewpoint of  $\Sigma'$ -observer.

All cinematic functions in the Case B are to depend on time  $t'$ , hence there is no need to inverse variables in Eq.21, giving relation of time-lines length: proper one,  $t'$ , and “observed” one,  $t$ . Nonetheless it seems useful to put down several first terms of the development

$$t = t' - \frac{\beta^2}{4} \left( t' - \frac{1}{2\Omega'} \sin 2\Omega' t' \right) + \frac{5\beta^4}{16 \cdot 4!} \left[ t' + \frac{1}{\Omega'} (2 \sin 4\Omega' t' - 4 \sin 2\Omega' t') \right] + \dots \quad (21a)$$

Comparing Eq.21a with its analogue Eq.10a one notes symmetry of time-functions in the least  $\beta^2$ -approximation for Cases A and B; this is too an expected relativistic result of exchanging observation bases.

In the Case B whole of cinematic problem has exact solution.

$\Sigma$  ( $\Sigma'$ ) Velocity

$$V'(t') = c \tanh(\beta \sin \Omega' t'). \quad (24)$$

For practical purposes it is useful to consider approximation up to small  $\beta^2 = (V_0 / c)^2$

$$V'(t') \cong V_0 \sin \Omega' t' \left( 1 - \frac{\beta^2}{3} \sin^2 \Omega' t' \right).$$

Minimal value velocity  $V(T') = 0$  acquires at the beginning and the end of each oscillation, at these moments the two frames are immobile to each other. Maximal value (V-amplitude) velocity has at quarter of period

$$\tilde{V}'(T'/4) = c \tanh \frac{V_0}{c}.$$

#### $\Sigma$ ( $\Sigma'$ ) Acceleration

$$a'(t') = \frac{dV(t')}{dt'} = \frac{V_0 \Omega' \cos \Omega' t'}{\cosh^2(\beta \sin \Omega' t')}; \quad (25)$$

its  $\beta^2$ -approximation is

$$a'(t') = \frac{dV(t')}{dt'} \cong \Omega \tilde{V} \cos \Omega t (1 - \beta^2 \sin^2 \Omega' t').$$

Minimal and maximal values respectively are

$$a'(T'/4) = 0, \quad a'(T') = V_0 \Omega'.$$

#### $\Sigma$ ( $\Sigma'$ ) Coordinate

$$x'(t') = \int V'(t') dt' = \int c \tanh(\beta \sin \Omega' t') dt'.$$

This function too can be integrated exactly due to (i) existence of divergent series

$$\tanh u = \sum_{n=1}^{\infty} \frac{2^{2n} (2^{2n} - 1) B_n}{(2n)!} u^{2n-1}, \quad |u| \equiv |\beta \sin \Omega' t'| < \pi/2,$$

whose coefficients are Bernoulli numbers tied by recurrent formula

$$B_n \equiv (-1)^n \left[ \frac{1}{2n+1} - \frac{1}{2} + \sum_{k=1}^{n-1} (-1)^{k-1} \frac{B_k (2n)(2n-1)(2n-2)\dots(2n-k+2)}{(2k)!} \right]$$

so that  $B_1 = 1/6$ ,  $B_2 = -1/30$ , and (ii) existence of table integral

$$\int \sin^{2n-1} y \, dy = \frac{(-1)^n}{2^{2n-2}} \sum_{k=0}^{n-1} (-1)^k \binom{2n-1}{k} \frac{\cos(2n-1-2k)y}{2n-1-2k};$$

here  $y \equiv \Omega' t'$ . Resulting coordinate function of time has the form

$$x'(t') = x_0 + \frac{c}{\Omega'} \sum_{n=1}^{\infty} \frac{2^{2n} (2^{2n} - 1) B_n}{(2n)!} \beta^{2n-1} \frac{(-1)^n}{2^{2n-2}} \sum_{k=0}^{n-1} (-1)^k \binom{2n-1}{k} \frac{\cos(2n-1-2k)\Omega' t'}{2n-1-2k}, \quad (26)$$

its  $\beta^2$ -approximation is

$$x'(t') = x'_0 - \frac{V_0}{\Omega'} \cos \Omega' t' \left[ 1 - \frac{1}{3} \beta^2 \left( 1 - \frac{1}{3} \cos^2 \Omega t \right) \right].$$

Integration constant

$$x'_0 = \frac{V_0}{\Omega'} \left( 1 - \frac{2}{3} \beta^2 \right)$$

is chosen so that the following conditions are satisfied

$$x'(0) = x'(T') = 0, \quad x'(T'/4) = x'_0, \quad x'(T'/2) = 2x'_0$$

meaning that at the beginning and the end of oscillation relatively immobile frames are found at the same space point.

Thus the cinematic problem for  $\Sigma'$ -observer is shown to have exact solution, it is represented by Eqs.24, 25, 26, and their weak-relativity approximations with  $\beta \ll 1$  are given.

### **Clock paradox discussion**

Specific features of the discussed relativistic oscillator model make it an appropriate cinematic system for discussion of famous clock paradox formulated in Special Relativity (SR) a century ago. First, one of the two involved frames of the system is always immobile (inertial) while the other is accelerated hence obviously non-inertial. Second, at starting and final moments the initial points of the frames spatially coincide while the frames are recip-



roccally at rest. Third, oscillating frame itself can serve as a clock for both observers. And last but not least, the key formulae describing time correlations are exact solutions.

Frequent explanation of the paradox relates clock delay to non-inertiality of motion (e.g. [7,8]). But if one considers two identical non-inertial frames moving in opposite directions the paradox seems to arise again: alleged non-inertial (“gravitational”) delay of the both clocks should be exactly the same, but accordingly to SR locally, at any moment, each observer detects his/her partner’s time slowing down. Conventional SR seems not to be able to cope with the problem.

The clock paradox can be regarded as a result of “one-side” measurement procedure, when two cinematically different time intervals of the same observation are measured by a time-unit of one observer; in this case they obviously will have different “length”. But if each interval is measured by time-unit of its own observer the lengths should be equal similar to the case of distance measurement: indeed, moving ruler seems to immobile observer shorter but it has the same “number of centimeters” as an identical ruler at rest.

Discussed above oscillating frame seems to be a successful illustration to the explanation of paradox given further in terms of space-traveling twins. Fig.1 shows Minkowski diagram of the oscillation process from the viewpoint of inertial (“immobile”)  $\Sigma$ -twin. Let time-segments subject to measurement be periods  $T$  and  $T'$  “observed” from  $\Sigma$ , hence interconnected by Eq.11, while a “ $\Sigma$ -second” ( $\Sigma$ -time-unit) is

$$\tau \equiv T / 4 = \pi / 2\Omega .$$

Then the “length” of segment  $T$  is 4 sec. Period  $T'$  measured in  $\Sigma$ -twin time-units  $\tau$  appears obviously shorter, so that returning home twin-traveler is allegedly younger than his brother-observer. This “one-side” measurement gives incorrect result since for  $\Sigma$ -twin not only  $\Sigma'$ -time-segment contracts but  $\Sigma'$ -time-unit too, adequate change of “ $\Sigma'$ -seconds” (in this case all equal) extracted from Eq.11



signal occurs at the very end of mission, at the same space point, at zero relative velocity, and the age of twins at the meeting point remains equal.

Besides, Fig.1 shows that projections of equal in length but different  $\Sigma'$ -time segments onto  $\Sigma$ -time (straight) line are also different, but they change steadily as smooth functions, and in three points of the twins relative immobility (0-0', 2-2', 4-4') their units smoothly became equal. This means that this model is free of "lost time" or "unit gap" features sometimes present in discussions of non-inertial approach to the paradox from Special Relativity position.

There are two final remarks.

1. Found relativistic solution for oscillator system frequent in nature and in description of many physical processes remarkably incorporates to the set of non-inertial cinematic problems already solved in the framework of Q- relativity theory from the viewpoint of all involved observers: hyperbolic motion, circular motion and Thomas-like precession [9].

2. In the study an accent may be made on the method used to endow a frame with definite non-inertial character. The method can serve as an instructive example helpful for construction of any non-inertial frame provided the acceleration law is given; this allows easier formulation and solution of new relativistic problems involving non-inertially moving observers.

### **Acknowledgment**

The author greatly appreciates kind suggestion of Victor Christianto to incorporate to this book.

## References

1. E.A.B.Cole, J.M. Starr (1985) *Six-Dimensional Relativity: Physical Appearance of a Particle whose Path Time Changes*, Lett. Nuovo Cim., , 43 № 8, P. 388-392.
2. A.P.Yefremov (1996) *Quaternionic Relativity. I. Inertial Motion*, Gravitation & Cosmology, Vol. 2, № 1, 77-83, 1996.
3. A.P.Yefremov (1996) *Quaternionic Relativity. II. Non-Inertial Motion*, Gravitation & Cosmology, Vol. 2, № 4, 335-341, 1996.
4. A.P.Yefremov (2000) *Six dimensional Rotational relativity*, Acta Phys. Hung., Series – Heavy Ions, Vol. 11 (1-2), 147-153, 2000.
5. A.P.Yefremov (1997) *On Twin Paradox in Quaternionic Relativity*, Gravitation & Cosmology, Vol. 3, № 3, 200-203, 1997.
6. L.Landau, E.Lifshits (1973), *Field Theory*. Moscow, Nauka publ. (in Russian).
7. H.Bondy (1967) *Assumption and Mith in Physical Theory*, Cambridge Univ. Press.
8. M.G.Bowler (1976) *Gravitation and Relativity*, Pergamon Press, Oxford-N.Y.-Toronto-Sydney-Paris-Frankfurt.
9. A.P.Yefremov (2004) *Quaternionic Program, Generalized Theories and Experiments*, Kluwer Acad. Publ., Netherlands, 395-409.

# Quaternionic Relativity. II Non-Inertial Motions\*.

Alexander P. Yefremov\*\*

Peoples' Friendship University of Russia, Miklukho-Maklaya Str., 6, Moscow, 117198,  
Russia.

In the framework of six-dimensional quaternionic theory of relativity (a short review is given) non-inertial frames are reasonably described: *uniformly accelerated observer* on rectilinear trajectory and arbitrary accelerated observer on circular orbit. The results are used to derive exact Thomas precession formula and calculate change of position of Jupiter's satellite observed from Earth, an integral cinematic effect for frames with variable relative velocity.

## Section 1. Introduction.

As is shown in previous paper [1] relative motion of particles and frames can be non-contradictorily described within framework of six-dimensional non-Abelian scheme based upon fundamental properties of quaternionic (Q) algebra. The key point of the scheme is Q-multiplication rule for one "real" unit, 1, and three "imaginary" units  $\mathbf{q}_k$  ( $k = 1, 2, 3$ )

$$1\mathbf{q}_k = \mathbf{q}_k 1 = \mathbf{q}_k, \quad \mathbf{q}_k \mathbf{q}_j = -\delta_{kj} 1 + \varepsilon_{kjm} \mathbf{q}_m \quad (1)$$

where  $\delta_{kj}$  and  $\varepsilon_{kjm}$  are Kroneker and Levi-Civita symbols, summation rule is valid. The non-Abelian units  $\mathbf{q}_k$  geometrically can be treated as unit vectors of an orthonormal triad. Such a triad admits ordinary R-rotations with real parameters  $\Phi_\xi$  (e.g. the angles of subsequent rotations  $\Phi_1 = \alpha$ ,  $\Phi_2 = \beta$ ,  $\Phi_3 = \gamma$ ):  $R(\Phi_\xi) \in SO(3, R)$ . In this case any real Q-vector  $\mathbf{a} \equiv a_k \mathbf{q}_k$  is a  $SO(3, R)$ -invariant  $a_k \mathbf{q}_k = a_{k'} \mathbf{q}_{k'}$  with  $\mathbf{q}_{k'} \equiv R_{k'j}(\Phi_\xi) \mathbf{q}_j$ .

Parameters of transformation leaving the multiplication rule (1) intact can be complex, and in particular pure imaginary:  $\Phi_\xi \rightarrow i\Psi_\xi$ . Then real rotations convert into hyperbolic ones  $R(\Phi_\xi) \rightarrow H(\Psi_\xi)$  while the respective invariance is sought for a vector biquaternion

$$\mathbf{u} \equiv (a_k + ib_k) \mathbf{q}_k.$$

The latter can be rewritten as

$$\mathbf{u} = a_k \mathbf{q}_k + b_k \mathbf{p}_k$$

where  $\mathbf{p}_k \equiv i\mathbf{q}_k$  are three unit vectors obeying the Pauli-matrices multiplication rule. This new triad is rigidly attached to  $\mathbf{q}_k$ , but defines scales and directions in a three-space imaginary with respect to initial one. Necessary condition for the Q-vector  $\mathbf{u}$  to be invariant under H-rotations is the orthogonality of its vector parts  $a_k b_k = 0$ . All such biquaternions possess real norm (zero included). The orthogonality condition allows representing  $\mathbf{u}$  in the simplest form

$$\mathbf{u} = a\mathbf{q}_1 + b\mathbf{p}_2,$$

---

\* *Gravitation & Cosmology*, Vol. 2 (1996), No.4(8), p.p. 333-341. [Editorial note: this early paper on Q-relativity is included here to accompany more recent paper by the same author: "Relativistic Oscillator in Quaternion Relativity." Section 5 in particular may yield new observation.]

\*\* e-mail: [a.yefremov@rudn.ru](mailto:a.yefremov@rudn.ru)

where  $a, b$  are lengths of the respective vectors. The complete group of transformations preserving  $\mathbf{u}$  invariant is  $SO(1,2) \subset SO(3,C)$ , the latter being the most general group of the Q-multiplication rule (1) invariance. It means that provided one  $\mathbf{q}_k$  (e.g.  $\mathbf{q}_1$  or  $\mathbf{p}_1$ ) is chosen to perform about it R-rotations, the other two ( $\mathbf{q}_2, \mathbf{q}_3$ ) can only serve as axes of H-rotations.

Q-relativity arises when  $\mathbf{u}$ -like vector

$$dz = dt_k \mathbf{p}_k + dx_k \mathbf{q}_k \quad (2)$$

is considered as specific space-time interval with  $dx_k$  being displacement and  $dt_k$  respective change-of-time (both vectors!  $dx_k dt_k = 0$ ) of a particle observed from a frame of reference  $\Sigma \equiv \{\mathbf{p}_k, \mathbf{q}_k\}$ . Fundamental velocity is taken for a unity.  $SO(1,2)$ -invariance of the “interval” (2) under finite R- and H-rotations (transfer from one inertial frame to another) leads to cinematic relations all equivalent to those of the Einstein’s Special Relativity [1].

A most simple constant frame  $\Sigma$  is represented e.g. by Pauli-type matrices

$$\mathbf{q}_1 = -i \begin{pmatrix} 0 & 1 \\ 1 & 0 \end{pmatrix}, \quad \mathbf{q}_2 = -i \begin{pmatrix} 0 & -i \\ i & 0 \end{pmatrix}, \quad \mathbf{q}_3 = -i \begin{pmatrix} 1 & 0 \\ 0 & -1 \end{pmatrix}. \quad (3)$$

The triad may be realized by a platform with three gyroscopes immobile relatively to “distant stars”: the observer in  $\Sigma$  ”feels” no acceleration.

On the other hand the most general Q-frames may be functions of complex parameters  $Z_\xi = \Phi_\xi + \Psi_\xi$ :

$$\mathbf{q}_{k'}(Z_\xi) = O(Z_\xi)_{k'j} \mathbf{q}_j. \quad (4)$$

There is no evident obstacle for parameters of the transformation  $O(Z_\xi) \in SO(1,2)$  to be localized; natural is a frame’s dependence upon its proper time:

$$\Sigma'(t') = \{\mathbf{p}_{k'}[Z_\xi(t')], \mathbf{q}_{k'}[Z_\xi(t')]\}. \quad (5)$$

Q-frames of the type (5) are non-inertial ones, some of them having very complicated behaviour. Before considering the situation in general it seems reasonable to analyze relativistic motion in simple non-inertial cases.

In Section 2 rectilinear *uniformly accelerated motion* is investigated in detail. Section 3 is devoted to *accelerated circular motion*. In Section 3 classical example of Thomas precession is treated from quaternionic relativity viewpoint. Computation of an integral relativistic effect for two frames with variable relative velocity is suggested in Section 5. Discussion and perspectives are found in Section 6.

## Section 2. Uniformly accelerated rectilinear motion.

This simplest case of accelerated observer is known as hyperbolic motion [2], [3]. The motion is usually treated from SR-positions but with the help of necessary additional *assumptions* (*time-dependence of four-velocity*, demand of Fermi-Walker transport of the observer’s tetrad) appropriate rather for GR. The Q-relativity approach allows treating the motion without loss of the theory’s logic.

If  $\Sigma'$  is a frame uniformly accelerated along its  $\mathbf{q}_2$ , then observer in  $\Sigma'$  must feel acceleration  $\varepsilon = \text{const}$  as in Einstein’s elevator. This implies specific dependence of  $\Sigma'$  on its proper time  $t'$ ; the dependence is found out of following considerations.

Let  $\Sigma'$  move relatively to inertial frame  $\Sigma$  (3) along its  $\mathbf{q}_2$ . If  $\Sigma'$  is observed then the simplest form of interval (2) in this case is

$$dz' \equiv dt' \mathbf{p}_{1'} = dt' \mathbf{p}_1 + dr \mathbf{q}_2, \quad (6)$$

what is equivalent to the H-rotation

$$\mathbf{q}' = H_3^\psi \mathbf{q},$$

or in explicit form

$$\begin{pmatrix} \mathbf{q}_{1'} \\ \mathbf{q}_{2'} \\ \mathbf{q}_{3'} \end{pmatrix} = \begin{pmatrix} \cosh \psi & -i \sinh \psi & 0 \\ i \sinh \psi & \cosh \psi & 0 \\ 0 & 0 & 1 \end{pmatrix} \begin{pmatrix} \mathbf{q}_1 \\ \mathbf{q}_2 \\ \mathbf{q}_3 \end{pmatrix}. \quad (7)$$

with

$$\psi(t') = ar \tanh \frac{dr}{dt}. \quad (8)$$

Analogously to what was done in [1] for Newtonian non-inertial motion one may compute cinematic Q-vectors of  $\Sigma'$ : its proper Q-velocity:

$$\mathbf{v}' \equiv \frac{d\mathbf{z}'}{dt'} = \mathbf{p}_{1'} \quad (9)$$

naturally containing the only unit time-like component, and Q-acceleration:

$$\mathbf{a}' \equiv \frac{d\mathbf{v}'}{dt'} = \frac{d\mathbf{p}_{1'}}{dt'}. \quad (10)$$

Computation of Q-acceleration (10) involves notion of quaternionic connection [1, 4]. For a triad obtained from a constant one as in Eq.(4) the derivative of  $\mathbf{q}_{k'}$  in the group space is expressed through coefficients of antisymmetric connection  $\omega_{\xi k'n'} = -\omega_{\xi'n'k}$ :

$$\frac{d\mathbf{q}_{k'}}{dZ_\xi} = \omega_{\xi k'n'} \mathbf{q}_{n'}. \quad (11)$$

From Eqs.(11), (4) the connection components are found as

$$\omega_{\xi k'n'} = \frac{dO_{k'm}}{dZ_\xi} O_{n'm}. \quad (12)$$

If group parameters depend on observer's time then the time derivative is defined

$$\frac{d\mathbf{q}_{k'}}{dt} = \frac{dZ_\xi}{dt} \omega_{\xi k'n'} \mathbf{q}_{n'} \equiv \omega_{k'n'} \mathbf{q}_{n'} \quad (13)$$

with

$$\omega_{k'n'} \equiv \frac{dZ_\xi}{dt} \omega_{\xi k'n'}. \quad (14)$$

Using Eqs.(12), (14) and (7) computation of the Q-acceleration (10) is straightforward

$$\mathbf{a}' = i \frac{d\mathbf{q}_{1'}}{dt'} = i \omega_{1'2'} \mathbf{q}_{2'} + i \omega_{1'3'} \mathbf{q}_{3'} = \frac{d\psi}{dt'} \mathbf{q}_{2'}. \quad (15)$$

Eq.(15) states that the only component of  $\mathbf{a}'$  is the acceleration of  $\Sigma'$  "felt" by its own observer, hence

$$\frac{d\psi}{dt'} = \varepsilon,$$

or

$$\begin{aligned} \psi &= \varepsilon t', \\ \psi_{t'=0} &= 0. \end{aligned} \quad (16)$$

Now general cinematic problem (i.e. functions of time, coordinate, velocity and acceleration of the Q-frames) is easily solved.

Case (a). Frame  $\Sigma'$  is observed; interval  $d\mathbf{z}'$  has the form (6) therefore

$$dt = dt' \cosh(\varepsilon t').$$

After integration one obtains time-correlation equations (integration constant is assumed zero)

$$t = \frac{1}{\varepsilon} \sinh(\varepsilon t')$$

or

$$t' = \frac{1}{\varepsilon} ar \sinh(\varepsilon t) = \frac{1}{\varepsilon} \ln[\varepsilon t + \sqrt{1 + (\varepsilon t)^2}]. \quad (17)$$

Velocity dependence on  $t$  is found from  $v = \tanh(\varepsilon t')$  with  $t$  substituted by  $t'$  from (17)

$$v(t) = \tanh[ar \sinh(\varepsilon t)] = \frac{\varepsilon t}{\sqrt{1 + (\varepsilon t)^2}}. \quad (18)$$

Integration of (18) yields the  $\Sigma'$ -motion law

$$r(t) = \frac{1}{\varepsilon} \sqrt{1 + (\varepsilon t)^2} - \frac{1}{\varepsilon}, \quad (19)$$

(integration constant is  $-1/\varepsilon$ ), while differentiation of (18) with respect to  $t$  gives *acceleration* of  $\Sigma'$  seen from  $\Sigma$

$$a(t) = \frac{\varepsilon}{[1 + (\varepsilon t)^2]^{3/2}}. \quad (20)$$

Cinematic problem is solved; the results precisely repeat those of [2,3]. For small  $t$ :  $t' \rightarrow t$ ,  $a(t) \rightarrow \varepsilon = \text{const}$ ,  $v(t) \rightarrow \varepsilon t$  and  $r(t) \rightarrow \varepsilon^2 t^2 / 2$  as it must be for non-relativistic uniformly accelerated motion. If  $t \rightarrow \infty$  then  $t' \rightarrow \frac{1}{\varepsilon} \ln(2\varepsilon t) \rightarrow \infty$ ,  $a \rightarrow \varepsilon^{-2} t^{-3} \rightarrow 0$ ,  $v \rightarrow 1$  and  $r \rightarrow t \rightarrow \infty$  as is natural from SR viewpoint.

Case (b). Frame  $\Sigma$  is observed; the interval takes the form

$$dz \equiv dt' \mathbf{p}'_1 - dr' \mathbf{q}'_2 = dt \mathbf{p}_1 \quad (21)$$

where  $-dr'$  is apparent displacement of the origin of  $\Sigma$  in a time  $dt'$  measured in  $\Sigma'$ . H-rotation parameter is given by Eq.(16), inertial  $\Sigma$ -observer obviously feels no acceleration

$$\mathbf{a} \equiv \frac{d\mathbf{z}'}{dt} = 0.$$

The cinematic problem is solved analogously

$$dt = \frac{dt'}{\cosh(\varepsilon t')}, \quad (22)$$

$$t(t') = \frac{1}{\varepsilon} \arctan[\sinh(\varepsilon t')] \equiv \frac{1}{\varepsilon} \arcsin[\tanh(\varepsilon t')], \quad (23)$$

$$v'(t') = \tanh(\varepsilon t'), \quad (24)$$

$$r'(t') = \frac{1}{\varepsilon} \ln[\cosh(\varepsilon t')], \quad (25)$$

$$a'(t') = \frac{\varepsilon}{\cosh^2(\varepsilon t')}. \quad (26)$$

Behaviour of the quantities in characteristic points of time-ray is the following. If  $t' \rightarrow 0$  then  $t \rightarrow t'$ ,  $a'(t') \rightarrow \varepsilon = \text{const}$ ,  $v' \rightarrow \varepsilon t'$  and  $r'(t') \rightarrow \varepsilon'^2 t'^2 / 2$  as is normal for non-relativistic uniformly accelerated motion. If  $t' \rightarrow \infty$  then  $a' \rightarrow 2\varepsilon e^{-2\varepsilon t'} \rightarrow 0$ ,  $v' \rightarrow 1$ ,  $r' \rightarrow t' \rightarrow \infty$  which agrees with notions of SR. Asymptotic behaviour of time is specific. Eq.(23) implies that observer in  $\Sigma'$  finds the clock of  $\Sigma$  more and more slow; at infinite time  $t' \rightarrow \infty$  the  $\Sigma$ -clock tends to stop on the value  $\frac{\pi c}{2\varepsilon}$  ( $c$  is the fundamental velocity).

An important feature of time measurement must be emphasized here. The matter is that Eqs.(17-20) and (23-26) give such values of cinematic quantities as if frames  $\Sigma'$  and  $\Sigma$



exchange information instantly. Actually in vacuum the signal travels with velocity  $c = 1$ , so the information about physical status of the object reaches distant observer at a later time.

In the case (a) this time is

$$t_r = t + r(t). \quad (27)$$

Substitution of Eq.(19) into (27) allows to express  $t$  as function of  $t_r$

$$t = \frac{1}{2}t_r \left( 1 + \frac{1}{1 + \mathcal{E}_r} \right). \quad (28)$$

Now instant time  $t$  can be replaced in Eqs. (17-20) by retarded time  $t_r$  that the observer reads from his clock. Thus recalculated velocity of  $\Sigma'$  is

$$v(t_r) = \frac{\mathcal{E}_r \left( 1 + \frac{1}{1 + \mathcal{E}_r} \right)}{\sqrt{4 + \left[ \mathcal{E}_r \left( 1 + \frac{1}{1 + \mathcal{E}_r} \right) \right]^2}}. \quad (29)$$

Closely to zero and asymptotically  $t$  and  $t_r$  are similar: if  $t \rightarrow 0$ , then  $t_r \rightarrow t \rightarrow 0$ ; if  $t \rightarrow \infty$ , then  $t_r \rightarrow 2t \rightarrow \infty$ .

In the case (b) the retarded time is

$$t'_r = t' + r'(t'). \quad (30)$$

Time-recalculation formula follows from Eqs.(25) and (30)

$$t' = \frac{1}{2\mathcal{E}} \ln(2e^{\mathcal{E}t'_r} - 1). \quad (31)$$

Eq.(31) helps to introduce time  $t'_r$  into Eqs.(23-26); e.g. “observed” velocity of  $\Sigma$  for  $\Sigma'$  clock is

$$v'(t'_r) = \tanh \left[ \frac{1}{2} \ln(2e^{\mathcal{E}t'_r} - 1) \right]. \quad (32)$$

For  $t' \rightarrow 0$ ,  $t' \rightarrow \infty$  behaviour of  $t'$  and  $t'_r$  is similar.

The *retarded time problem* within framework of non-inertial relativity is much wider. It comprises experimental aspects: since position and velocity of an object are really measured in retarded time, there might be a need for knowledge of “instant” values. Establishing of mathematical ties between retarded quantities also will be helpful to see the whole picture on the base of available data. Detailed analysis of these aspects will be given in a separate paper.

### Section 3. Circular motion.

The simplest curvilinear accelerated motion is circular motion. In the Q-relativity framework it needs at least two types of group parameters: a real (rotational) one and an imaginary (hyperbolic) one.

Let the origin of  $\Sigma$  lie in the centre and vectors  $\mathbf{q}_2, \mathbf{q}_3$  in the plane of circular orbit (with radius  $R$ ) of the frame  $\Sigma'$  (Fig.1). There are two steps in building cinematic relativistic model.

The first step is non-relativistic construction of the object's displacement. In the base  $\Sigma$  the coordinates of  $\Sigma'$  are

$$x_2 = R \cos \alpha(t), \quad x_3 = R \sin \alpha(t), \quad x_1 = 0.$$

Make one of the triad vectors, say the third, be always parallel to the  $\Sigma'$  velocity

$$\mathbf{q}_3 \equiv \frac{\dot{x}_k}{\sqrt{\dot{x}_j \dot{x}_j}} \mathbf{q}_k = -\sin \alpha \mathbf{q}_2 + \cos \alpha \mathbf{q}_3;$$

this as a part of the simple R-rotation

$$\bar{\Sigma} = R_1^{\alpha(t)} \Sigma,$$

or in explicate form

$$\begin{pmatrix} \mathbf{q}_1 \\ \mathbf{q}_2 \\ \mathbf{q}_3 \end{pmatrix} = \begin{pmatrix} 1 & 0 & 0 \\ 0 & \cos \alpha & \sin \alpha \\ 0 & -\sin \alpha & \cos \alpha \end{pmatrix} \begin{pmatrix} \mathbf{q}_1 \\ \mathbf{q}_2 \\ \mathbf{q}_3 \end{pmatrix}. \quad (33)$$

From non-relativistic viewpoint interpretation of  $\bar{\Sigma}$  is two-folded. On one hand it can be treated as a frame rotating in the orbit's centre with angular velocity  $\omega(t) \equiv \dot{\alpha}$ ; its  $\mathbf{q}_2$  is constantly chasing the origin of the frame on orbit. On the other hand  $\bar{\Sigma}$  represents a frame revolving on the orbit with speed  $v = \omega R$  its displacement being  $dr = \omega R dt$ .

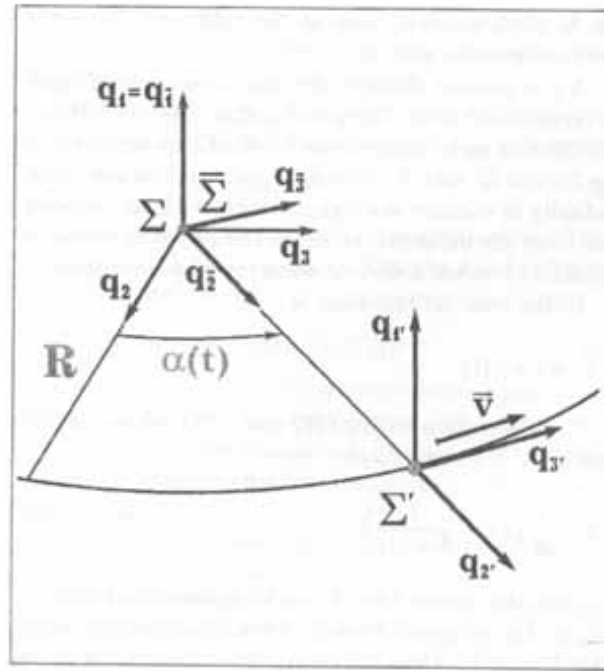

Figure 1: Circular motion

The second step is to “switch” relativity, i.e. to “H-rotate”  $\bar{\Sigma}$  at “angle”  $\psi = ar \tanh(\omega R)$  about  $\mathbf{q}_2$ , so that change-of-time vector becomes aligned with  $\mathbf{q}_1 = \mathbf{q}_1$  not involved into description of space cinematic quantities

$$\Sigma' = H_{\frac{\psi}{2}} \bar{\Sigma},$$

or

$$\begin{pmatrix} \mathbf{q}_{1'} \\ \mathbf{q}_{2'} \\ \mathbf{q}_{3'} \end{pmatrix} = \begin{pmatrix} \cosh \psi & 0 & -i \sinh \psi \\ 0 & 1 & 0 \\ i \sinh \psi & 0 & \cosh \psi \end{pmatrix} \begin{pmatrix} \mathbf{q}_1 \\ \mathbf{q}_2 \\ \mathbf{q}_3 \end{pmatrix}. \quad (34)$$

Altogether  $\Sigma'$  is combination of two subsequent rotations (20) and (21) subject to SO(1,2) symmetry

$$\Sigma' = H_{\frac{\psi}{2}} R_1^{\alpha} \Sigma. \quad (35)$$

Q-acceleration felt by  $\Sigma'$ -observer

$$\mathbf{a}' = i \frac{d\mathbf{q}_{1'}}{dt'} = i\omega_{1'2'} \mathbf{q}_{2'} + i\omega_{1'3'} \mathbf{q}_{3'}$$

is found from (35) with the help of Eqs.(12, 14)

$$\mathbf{a}' = -\frac{d\alpha}{dt'} \sinh \psi \mathbf{q}_2 + \frac{d\psi}{dt'} \mathbf{q}_3.$$

Here are normal (centripetal)

$$a_{norm} = -\frac{d\alpha}{dt'} \sinh \psi$$

and tangent (angular)

$$a_{tan} = \frac{d\psi}{dt'}$$

components of the acceleration.

For simple cases the components are readily found. Uniform motion implies  $\psi = ar \tanh \omega' R' = const$  ( $\omega'$ ,  $R'$  are angular velocity, and the orbit's radius for  $\Sigma'$ -observer), therefore  $a_{tan} = 0$ ,  $\alpha = \omega' t'$ ,  $a_{norm} = \omega'^2 R' \cosh \psi = const$ . For uniformly accelerated motion  $\psi = ar \tanh \omega' R' = \lambda t'$  with  $\lambda = const$ , then  $a_{tan} = \lambda$ ,  $a_{norm} = \omega'^2(t') R' \cosh(\lambda t')$ . These are quite expected results.

Farther analysis of circular motion is made for general form of the hyperbolic parameter  $\psi = \psi(t')$  that is assumed given.

Case (aa). Frame  $\Sigma'$  is observed.

The interval expression is read from the first row of matrix Eq.(34) for rotating (non-inertial) base  $\bar{\Sigma}$ , or from the first row of Eq.(35) for the inertial base  $\Sigma$

$$d\mathbf{z}' \equiv idt' \mathbf{q}_1' = idt \mathbf{q}_1 + dt R \omega \mathbf{q}_3 = idt \mathbf{q}_1 + dt R \omega (-\sin \alpha \mathbf{q}_2 + \cos \alpha \mathbf{q}_3). \quad (36)$$

Procedure of solving the cinematic problem is analogous to that of Section 2. From Eq.(36) it follows

$$dt = dt' \cosh \psi(t'), \quad (37)$$

$$t = \int dt' \cosh \psi(t'), \quad (38)$$

and the inverse function  $t' = t'(t)$  is possibly found. The latter is used in expression for angular velocity

$$\omega(t) = \frac{1}{R} \tanh \psi[t'(t)]. \quad (39)$$

Eq.(38) yields  $\Sigma$ -time dependence of rotation angle

$$\alpha(t) = \int \omega(t) dt \quad (40)$$

and tangent acceleration

$$a_{tan}(t) = R \frac{d\omega(t)}{dt} = \frac{1}{\cosh^3 \psi} \frac{d\psi}{dt'}. \quad (41)$$

These are all quantities available for  $\bar{\Sigma}$ -observer. Observer in  $\Sigma$  additionally makes conclusion about normal part of the acceleration

$$a_{norm}(t) = R \left( \frac{d\alpha(t)}{dt} \right)^2. \quad (42)$$

Eqs.(38-42) represent solution of the cinematic problem.

An essential note must be made here. An arc segment collinear to relative velocity is relativistically contracted as in SR

$$dl = dl' \cosh \psi,$$

while the orbit's radius perpendicular to velocity and not involved into transformations remains the same for  $\Sigma$  and  $\Sigma'$

$$R' = R. \quad (43)$$

Hence in the case (a) the angle measures are related as

$$d\alpha = \frac{dl}{R} = \frac{dl'}{R'} \cosh \psi = d\alpha' \cosh \psi. \quad (44)$$

The last ratio together with Eqs.(43, 37) gives unique numerical value of the frames' angular velocities for respective observers

$$\omega(\Sigma) = \frac{d\alpha}{dt} = \frac{d\alpha'}{dt'} = \omega'(\Sigma'). \quad (45)$$

This result agrees with the axiomatic fact that for  $\Sigma$  and  $\Sigma'$  value of relative velocity (or hyperbolic parameter) is the same

$$v = \tanh \psi = \omega R = \omega' R'.$$

Case (bb). Frame  $\Sigma$  is observed.

The interval for  $\Sigma$  (and  $\bar{\Sigma}$ ) is equivalent to the first row of matrix equation

$$\Sigma = R_{\bar{1}}^{-\alpha} H_{2'}^{-\psi} \Sigma'$$

inverse to Eq.(35)

$$dz = dt \mathbf{p}_1 = dt \mathbf{p}_{\bar{1}} = dt' \mathbf{p}'_1 - R' \omega' dt' \mathbf{q}_3, \quad (46)$$

with

$$\omega' R' = \omega R = \tanh \psi(t').$$

Q-acceleration of  $\Sigma$  vanish

$$\mathbf{a} \equiv \frac{dz}{dt} = 0$$

since  $\Sigma$  -observer is considered genuinely immobile. In this case

$$dt' = dt \cosh \psi$$

$$t = \int \frac{dt'}{\cosh \psi(t')}. \quad (47)$$

$\Sigma'$  -observer is able to measure apparent cinematic quantities: velocity, angle and tangent acceleration

$$v = \tanh \psi(t'), \quad (48)$$

$$\alpha(t') = \int \frac{\tanh \psi(t')}{R} dt', \quad (49)$$

$$a_{\tan} = \frac{1}{\cosh^2 \psi} \frac{d\psi}{dt'}. \quad (50)$$

Eqs.(47-50) give solution of cinematic problem in the case (bb). Reasonable behaviour of the quantities is readily verified for simple types of circular motion in non-relativistic and ultrarelativistic limits.

In both cases (aa) and (bb) observers receive in fact retarded signals. But contrary to situation for rectilinear motion, here constant time delay does not influence noticeably values of cinematic quantities.

#### Section 4. Thomas precession.

Apparent rotation of genuinely constant "spin" vector of the top relativistically revolving about the origin of an inertial frame (Thomas precession) is regarded in SR either when circular trajectory is *approximated* by straight line segments [5] or when Fermi-Walker transport of vectors is postulated [3]. Quaternionic relativity suggests a shorter and more consistent way (from logical viewpoint) to describe the phenomenon.

Let  $\Sigma$  be an immobile Q-frame (3) in the centre of the circular orbit of another Q-frame,  $\Sigma''$  uniformly revolving about  $\Sigma$ . Respective observers find space vectors of their frames

constantly oriented. Notice that  $\Sigma''$  can be obtained from  $\Sigma'$  determined by Eq.(35) with the help of inverse R-rotation at appropriate angle  $-\alpha'$

$$\Sigma'' = R_1^{-\alpha'} H_2^\psi R_1^\alpha \Sigma, \quad (51)$$

or in explicit form

$$\begin{pmatrix} \mathbf{q}_{1r} \\ \mathbf{q}_{2r} \\ \mathbf{q}_{3r} \end{pmatrix} = \begin{pmatrix} 1 & 0 & 0 \\ 0 & \cos\alpha' & -\sin\alpha' \\ 0 & \sin\alpha' & \cos\alpha' \end{pmatrix} \begin{pmatrix} \cosh\psi & 0 & -i\sinh\psi \\ 0 & 1 & 0 \\ i\sinh\psi & 0 & \cosh\psi \end{pmatrix} \begin{pmatrix} 1 & 0 & 0 \\ 0 & \cos\alpha & \sin\alpha \\ 0 & -\sin\alpha & \cos\alpha \end{pmatrix} \begin{pmatrix} \mathbf{q}_1 \\ \mathbf{q}_2 \\ \mathbf{q}_3 \end{pmatrix}. \quad (52)$$

Suppose that angles of rotation are calculated in terms of laboratory time  $t$ :  $\alpha = \omega t$ ,  $\alpha' = \omega'(\Sigma)t$ . For the base  $\Sigma'$  proper (real) period  $T'(\Sigma')$  of its retrograde (second) rotation measured in  $\Sigma'$  due to Eq.(47) is related to apparent period  $T'(\Sigma)$  measured in  $\Sigma$  as

$$T'(\Sigma') = T'(\Sigma) \cosh\psi.$$

Then proper cyclic frequency of the rotation (measured in  $\Sigma'$ ) is

$$\omega'(\Sigma') = \frac{2\pi}{T'(\Sigma')} = \frac{2\pi}{T'(\Sigma) \cosh\psi} = \frac{\omega'(\Sigma)}{\cosh\psi},$$

or, taking into account Eq.(45),

$$\omega'(\Sigma) = \omega(\Sigma) \cosh\psi; \quad (53)$$

cyclic frequency of  $\Sigma'$  second rotation “seen” from  $\Sigma$  is  $\cosh\psi$  times bigger than that of first rotation of  $\Sigma$  measured in itself and needed to chase  $\Sigma'$ .

Now compute change of the top’s spin direction seen from  $\Sigma$  while in  $\Sigma''$  being constantly pointed at a distant star, say, along  $\mathbf{q}_{2r}$ , space unit vector of  $\Sigma''$ . From Eq.(52) vector  $\mathbf{q}_{2r}$  in projections onto unit vectors of  $\Sigma$  is

$$\begin{aligned} \mathbf{q}_{2r} = & -i\sinh\psi \sin\alpha \mathbf{q}_1 + (\cos\alpha \cos\alpha' + \cosh\psi \sin\alpha \sin\alpha') \mathbf{q}_2 + \\ & + (\sin\alpha \cos\alpha' - \cosh\psi \cos\alpha \sin\alpha') \mathbf{q}_3. \end{aligned} \quad (54)$$

Projections of  $\mathbf{q}_{2r}$  onto spatial directions of  $\Sigma$  allow us determining apparent precession, e.g. projection onto  $\mathbf{q}_3$

$$\langle \mathbf{q}_{2r} \rangle_3 = \sin(\alpha - \alpha') - \frac{1}{2} (\cosh\psi - 1) \sin\alpha \sin\alpha', \quad (55)$$

or after some algebra

$$\langle \mathbf{q}_{2r} \rangle_3 = \sin\{[\omega(\Sigma) - \omega'(\Sigma)]t\} - \sinh^2 \frac{\psi}{2} \sin\omega(\Sigma)t \sin\omega'(\Sigma)t. \quad (56)$$

Angular velocity of the first rhs term in Eq.(56)  $\omega_T \equiv \omega - \omega'$  corresponds to “mostly noticeable” Thomas precession. Due to Eq. (53) it can be presented as

$$\omega_T = \omega(1 - \cosh\psi); \quad (59)$$

for small relative  $\Sigma - \Sigma''$  velocities it takes the known form

$$\omega_T = -\frac{\omega}{2} v^2 \quad (60)$$

with  $v = \omega R$ . The second right-hand side term of Eq.(56) describes much “less noticeable” precession since its amplitude is  $v^2/c^2$  less than that of the first term. For small relative velocities the second term is  $-\frac{v^2}{4} \sin 2\omega t$ .

It is worth to note that results given by Eqs.(55, 56) precisely coincide with those found in [3]. The only difference is that due to SO(1,2)-symmetry preserving choice of R- and H-rotation axes no time-like components of spin ever appear.

### Section 5. Jupiter's satellite.

Presented relativistic treatment of circular motion suggests the following observational experiment aimed to control consistence of the theory. Consider a part of Solar system (Fig.2) where  $\tilde{\Sigma}$  is constant Q-frame with Sun as reference body,  $\Sigma'$  is attached to Earth, and  $\Sigma$  belongs to Jupiter. In non-relativistic limit relative Jupiter-Earth velocity is

$$V^2 = v_E^2 + v_J^2 - 2v_E v_J \cos(\alpha - \beta) \quad (61)$$

with constant orbit velocities of the planets

$$v_E = \omega_E R_E, v_J = \omega_J R_J$$

and respective radius angles measured from  $\mathbf{q}_{\tilde{\Sigma}}$  linearly depending on  $\tilde{\Sigma}$  time

$$\alpha = \omega_E \tilde{t}, \quad \beta = \omega_J \tilde{t}.$$

Picture of a satellite revolving about Jupiter and observed from Earth is similar of that regarded in Section 3. The only difference is that both object  $\Sigma$  and observer  $\Sigma'$  are non-inertial, their relative speed variable, and this is the crucial point. If the Earth's observer in a short period of time measures the satellite angular velocity  $\omega(\Sigma')$  and neglects influence of relative Earth-Jupiter motion then in time  $t'$  he computes the rotation angle as

$$\varphi_{theor} = \omega(\Sigma') t'.$$

In fact, according to Eq.(53), the *apparent angular velocity* is

$$\omega(\Sigma') = \omega \cosh \psi,$$

where  $\omega(\Sigma) \equiv \omega$  is genuine constant quantity measured on Jupiter. Since velocity of relative motion is variable,  $\omega(\Sigma')$  is variable too. Hence the rotation angle really observed from  $\Sigma'$  is found as

$$\varphi_{real} = \int \omega(\Sigma') dt' = \omega \int \cosh \psi(t') dt'.$$

Difference between computed and observed values of the angle is

$$\Delta\varphi \equiv \varphi_{real} - \varphi_{theor} = \omega [\cosh \psi(t'_0) - \int \cosh \psi(t') dt']. \quad (63)$$

Ratio  $V/c$  is small, so non-relativistic value of relative velocity (61) is sufficient

$$\cosh \psi \approx 1 + \frac{1}{2} \left[ \frac{V(t')}{c} \right]^2.$$

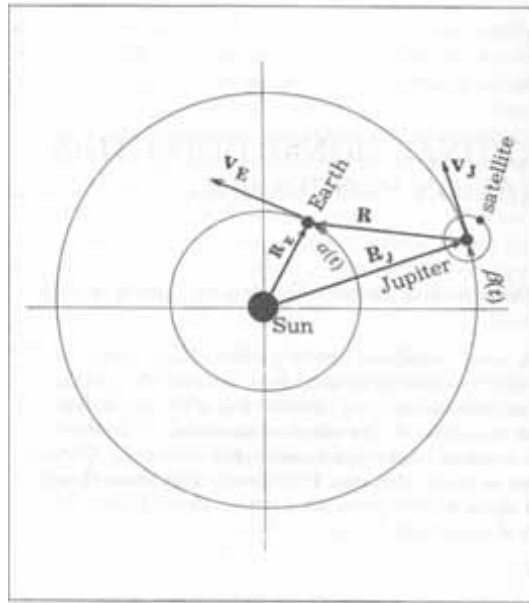

Figure 2: Jupiter's satellite

If at the moment of initial measurement  $t'_0$  velocities of Earth and Jupiter are parallel  $\vec{v}_E(t'_0) \uparrow \uparrow \vec{v}_J(t'_0)$ , then computed value of apparent angular velocity is minimal and Eq.(63) takes the form

$$\Delta\varphi \approx \frac{\omega v_E v_J}{c^2} \left[ 1 - \frac{\sin(\alpha - \beta)}{\alpha - \beta} \right] t'. \quad (64)$$

The second term in brackets tends to zero with time so that final formula is

$$\Delta\varphi \approx \frac{\omega v_E v_J}{c^2} t'. \quad (65)$$

For the closest Jupiter satellite (“Metes”)  $\omega = 2.5 \times 10^{-4} \text{ sec}^{-1}$ ,  $v_E = 30.4 \text{ km/sec}$ ,  $v_J = 31.1 \text{ km/sec}$  in one Jupiter year  $t' = 12 \text{ Earth years} = 3.7 \times 10^8 \text{ sec}$  the angle difference  $\Delta\varphi = 4.14 \times 10^{-4} \text{ rad} = 1.4'$  might be observable.

### Section 6. Discussion.

Examples given in paper [1] and above show that quaternionic approach to relativistic kinematics seems to provide consistent description of inertial and non-inertial frames of reference. In the framework of the theory all cinematic effects of Einstein’s Special Relativity are found as well as hyperbolic motion and Thomas precession, effects whose standard descriptions demand additional assumptions. The suggested relativistic scheme due to vectorial character of its space-time “interval” is obviously convenient to consider frames with curvilinear trajectories. In particular it permits to obtain plausible results of relativistic circular motion of general type and predict integral effects for frames with variable relative speed.

Nevertheless several examples whatever successful they were represent only separate pieces of unique theory. Kinematics of quaternionic relativity is not completed until the most general types of frames trajectories are taken into account. This is the task of next paper.

### References

- [1] A.P.Yefremov, *Gravitation & Cosmology*, Vol. 2 (1996), No.1(5), p.p. 77-83.
- [2] L.D.Landau, E.M.Lifshts, “Theory of Fields”, M., Nauka, 1973, p. 39.
- [3] Ch.W.Misner, K.S.Thorn, J.A.Wheeler, “Gravitation”, San Francisco, W.N.Freeman & Co., 1973, p.p. 166, 175.
- [4] A.P.Yefremov, *Izvestiya Vuzov, Fizika*, (1985), **12**, p.p. 14-18.
- [5] E.F.Taylor, J.A.Wheeler, “Spacetime Physics”, San Francisco, W.N.Freeman & Co., 1966, p.p. 222-228.

# Relativistic Doppler Effect and Thomas Precession on Arbitrary Trajectories (and comment on Pioneer anomaly)

Alexander P. Yefremov\*\*

\*\* Institute of Gravitation and Cosmology, Peoples' Friendship University of Russia,  
Miklukho-Maklaya Str., 6, Moscow, 117198, Russia. <http://www.rudn.ru>

## THEORY

### Formulation of question.

There are two relatively (and arbitrary) moving bodies A and B. In some coordinate system coordinates of A and B are given as  $\vec{r}_A(t)$ ,  $\vec{r}_B(t)$ ,  $t$  is A-observer's time. Body B sends light signal (with given on B wave-vector  $\vec{k}$ ,  $\vec{k}\vec{k} = 0$ ) towards body A.

Question is: what  $\vec{k}$  components A-observer detects?

### Solution.

1. Vectors of relative A-B coordinates  $\vec{r}$  and relative A-B velocity  $\vec{V}$  are found in  $\tilde{\Sigma}$ :

$$\vec{r} = \vec{r}_B - \vec{r}_A, \quad \vec{V} = d\vec{r} / dt = \dot{\vec{r}}_B - \dot{\vec{r}}_A.$$

2. A-observer sets a 3D Q-frame  $\Sigma = \{\mathbf{q}_n\}$  with one vector (e.g.  $\mathbf{q}_2$ ) aligned with  $\vec{r}$ , it pursuits body B. Another vector of  $\Sigma$  (e.g.  $\mathbf{q}_3$ ) lays in the instant plane formed by vectors  $\vec{r}$  and  $\vec{V}$ , while vector  $\mathbf{q}_1$  remains always orthogonal to the plane.

3. Before "switching on" relativity one needs first to spatially rotate  $\Sigma \rightarrow \bar{\Sigma}$  so that new vector  $\mathbf{q}_2$  becomes aligned with velocity  $\vec{V}$ , the rotation is done on A in the instant plane about vector  $\mathbf{q}_1$ :  $\bar{\Sigma} = O_1^{\alpha(t)}\Sigma$ , angle of rotation is found from scalar product:  $\cos \alpha(t) = \vec{r}\vec{V} / (rV)$ .

4. Now all is ready for relativity, and frame  $\bar{\Sigma}$  is "transported" from A to B:  $\bar{\Sigma} \rightarrow \bar{\Sigma}'$  by hyperbolic rotation so that "time" and "velocity" axes are involved, intact remains vector  $\mathbf{q}_3$ :  $\bar{\Sigma}' = O_3^{i\psi(t)}\bar{\Sigma}$ , imaginary "angle" of the rotation (velocity parameter) is  $\tanh \psi(t) = V/c$ ,  $c$  is fundamental velocity.

5. On body B "velocity aligned" frame  $\bar{\Sigma}'$  may be spatially rotated  $\bar{\Sigma}' \rightarrow \Sigma'$  so that new vector  $\mathbf{q}_2$  becomes oriented (for technical convenience) oppositely to direction where the light signal is sent; the rotation is again done in the instant plane about vector  $\mathbf{q}_1$ :  $\Sigma' = O_1^{-\beta(t')}\bar{\Sigma}'$ , angle of rotation  $\beta(t')$  is determined in B-time  $t'$ , tied with A-time  $t$  by ratio  $t' = \int \cosh \psi(t) dt$ . When  $\beta(t') = \alpha(t')$ ,  $\cos \alpha(t') = \vec{R}\vec{V} / (RV)$ , i.e. signal is sent from B towards A,  $\alpha'(t) = \alpha(t') \neq \alpha(t)$ .

6. The chain of rotations results in one Rotational Equation (main tool of Q-relativity)

$$\Sigma' = O_1^{-\beta} O_3^{i\psi} O_1^{\alpha} \Sigma = O\Sigma, \quad (1)$$

---

\*\* e-mail: [a.yefremov@rudn.ru](mailto:a.yefremov@rudn.ru)



with  $O \in SO(1,2)$ ; so any bi-quaternion vector is form-invariant under transformation (1), wave-vector included:  $k \Sigma = k' \Sigma'$ . From Eq. (1) one has  $\Sigma = O^{-1} \Sigma'$  hence invariance equation yields  $k \Sigma = k' O O^{-1} \Sigma'$ , or  $k = k' O$ . Since all values are known  $(\vec{k}, \alpha, \psi, \beta)$ , all components of wave-vector sent from B and “seen” by A-observer are found. Problem is solved.

Comment.

Eq. (1) has exactly the same form as Rotational Equation for classical Thomas precession problem solved for circular motion of observed spin. Essentially new feature is that here we succeeded to exhibit construction of rotational equation for the most general case: for arbitrary trajectories of involved bodies. Thus relativistic Doppler effect and Thomas precession effect are sister-solutions of the same relativistic model.

CALCULATIONS

Determine components of wave-vector  $\vec{k}$  in  $\Sigma$ , if in  $\Sigma'$  it is given as  $k_n = (i\omega'/c, -\omega'/c, 0)$ , with  $\omega'$  being signal’s frequency. Explicit form of Eq.  $k = k' O$  is

$$(k_1 \ k_2 \ k_3) = (k_{1'} \ k_{2'} \ k_{3'}) \begin{pmatrix} 1 & 0 & 0 \\ 0 & \cos \beta & -\sin \beta \\ 0 & \sin \beta & \cos \beta \end{pmatrix} \begin{pmatrix} \cosh \psi & -i \sinh \psi \cos \alpha & -i \sinh \psi \sin \alpha \\ i \sinh \psi & \cosh \psi \cos \alpha & \cosh \psi \sin \alpha \\ 0 & -\sin \alpha & \cos \alpha \end{pmatrix}.$$

First (“time”) component

$$k_1 = k_{1'} \cosh \psi + i k_{2'} \cosh \psi \sin \beta + i k_{3'} \sinh \psi \sin \beta,$$

or

$$\omega = \omega' (\cosh \psi - \sinh \psi \cos \beta) = \omega' \cosh \psi (1 - \tanh \psi \cos \beta)$$

what is the Doppler effect formula

$$\boxed{\omega = \frac{\omega'}{\sqrt{1 - (V/c)^2}} \left( 1 - \frac{V}{c} \cos \beta \right)}, \tag{2}$$

with completely determined functions  $V(t)$  and  $\beta(t)$ , hence the shift depends on time.

Relativistic non-equality of angles  $\beta(t')$  and  $\beta(t)$  makes this formula slightly different from that of Special Relativity.

Second (space) component

$$k_2 = (\omega'/c) (\sinh \psi \cos \alpha - \cosh \psi \cos \beta \cos \alpha - \sin \beta \sin \alpha),$$

or

$$k_2 = (\omega'/c) \cosh \psi \left[ \frac{V}{c} \cos \alpha - \cos(\alpha - \beta) + \left( 1 - \frac{1}{\cosh \psi} \right) \sin \beta \sin \alpha \right].$$

Third (space) component

$$k_3 = (\omega'/c) (\sinh \psi \sin \alpha - \cosh \psi \cos \beta \sin \alpha + \sin \beta \cos \alpha),$$

or

$$k_3 = \frac{\omega'}{c} \frac{1}{\sqrt{1 - (V/c)^2}} \left[ \frac{V}{c} \sin \alpha + \sin(\alpha - \beta) - \left( 1 - \frac{1}{\cosh \psi} \right) \sin \beta \cos \alpha \right].$$

The last component is a “relativistic aberration” of vector  $\vec{k}$ , same as apparent (on A) component of constantly oriented (on B) spin in Thomas precession scheme.

It is easily verified (e.g. by direct calculation) that

$$k_1^2 + k_2^2 + k_3^2 = 0.$$

Remarks.

1. Praising Q-relativity. Used rotational method offering straightforward computation of all components of any Q-vector in arbitrary moving frames helps to realize that some relativistic effects usually regarded different are in fact two solutions of unique problem.

2. Concerning Pioneer anomaly. One can use Eq. (2) with particular trajectory data to try to explain experimentally detected anomalous frequency shift of signals sent by Pioneer spacecrafts. We’ll try to give examples.

Consider simple case.

In Sun’s frame Craft travels with speed  $\vec{V}_C(t)$  along straight line inclined to ecliptic plane at angle  $\theta$ . Light signal is sent from Craft into direction of Sun.

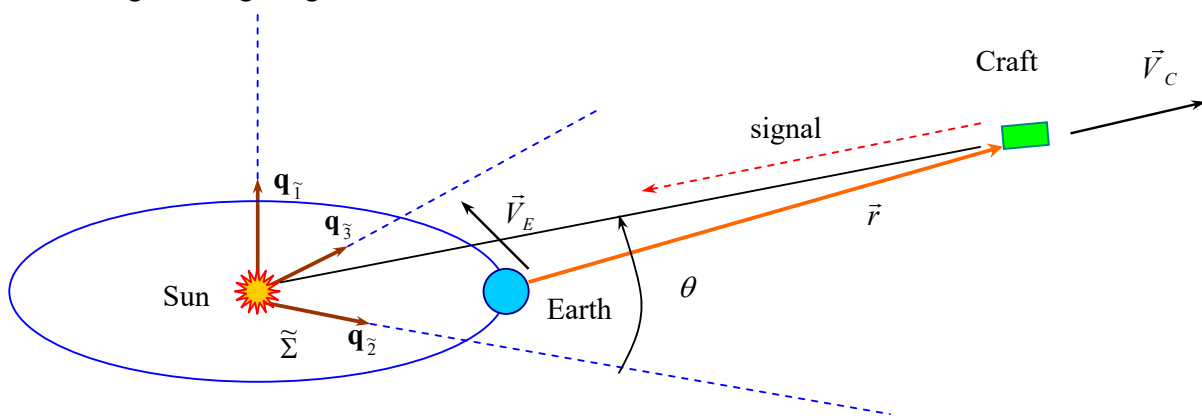

Frequency-shift formula is in Eq. (2)

$$\omega = \frac{\omega'}{\sqrt{1 - (V/c)^2}} \left( 1 - \frac{V}{c} \cos \beta \right),$$

where angle  $\beta$  between direction opposite Craft’s velocity and direction of signal is zero. Terms of order  $(V/c)^2$  and higher will be neglected. Then

$$\omega \cong \omega' \left( 1 - \frac{V(t)}{c} \right),$$

or

$$\Delta\omega = \omega' - \omega = V(t)/c. \tag{3}$$

Relative velocity modulus is determined straightforwardly

$$V = \sqrt{V_C^2 + V_E^2 - 2V_C V_E \cos \theta \sin \Omega t}.$$

Substitution this to Eq. (3) gives

$$\Delta\omega = \frac{\omega}{c} \sqrt{V_C^2(t) + V_E^2 - 2V_C(t)V_E \cos\theta \sin\Omega t} . \quad (4)$$

Time derivative of Eq. (4) determines change of the shift compared to that of Special Relativity

$$\frac{d}{dt} \Delta\omega = \frac{\omega}{c} \frac{\dot{\varepsilon}_K(t) - [V_E \dot{V}_C(t) \sin\Omega t + \Omega V_E V_C(t) \cos\Omega t] \cos\theta}{\sqrt{V_C^2(t) + V_E^2 - 2V_C(t)V_E \cos\theta \sin\Omega t}} \quad (5)$$

where  $\varepsilon_K = \frac{V_C^2}{2}$  is Craft's kinetic energy per unit mass in Sun's frame.

Analyzing Eq.(5) we see that dependence of involved functions on time contributes to secular anomaly while harmonic functions cause annual "modulations".

More complicated case. If Craft's trajectory is bending with time (like hyperbola tail with normal acceleration) but Craft insistently sends signal towards Sun or Earth, then the angle  $\beta(t) \neq 0$  and this will cause additional contribution to secular anomaly.

# Less mundane explanation of Pioneer anomaly from Q-relativity\*

F. Smarandache<sup>1</sup> & V. Christianto<sup>2</sup>

<sup>1</sup>. Department of Mathematics, University of New Mexico, NM 87301, USA, email: smarand@unm.edu

<sup>2</sup>. <http://www.sciprint.org>, email: admin@sciprint.org

There have been various explanations of Pioneer blueshift anomaly in the past few years; nonetheless no explanation has been offered from the viewpoint of Q-relativity physics. In the present paper it is argued that Pioneer anomalous blueshift may be caused by Pioneer spacecraft experiencing angular shift induced by similar Q-relativity effect which may also affect Jupiter satellites. By taking into consideration 'aether drift' effect, the proposed method as described herein could explain Pioneer blueshift anomaly within ~0.26% error range, which speaks for itself. Another new proposition of redshift quantization is also proposed from gravitational Bohr-radius which is consistent with Bohr-Sommerfeld quantization. Further observation is of course recommended in order to refute or verify this proposition.

## Introduction

In the past few years, it is becoming well-known that Pioneer spacecraft has exhibited an anomalous Doppler frequency blueshifting phenomenon which cannot be explained from conventional theories, including general relativity.[1][4] Despite the nature of such anomalous blueshift remains unknown, some people began to argue that a post-einsteinian gravitation theory may be in sight [1b], which may be considered as further generalisation of pseudo-Riemann metric of general relativity theory.

Nonetheless, at this point one may ask: Why do we require a generalization of pseudo-Riemann tensor, instead of using 'patch-work' as usual to modify general relativity theory? A possible answer is: sometimes too much patch-work doesn't add up. For instance, let us begin with a thought-experiment which forms the theoretical motivation behind general relativity, an elevator was put in free-falling motion.[8a] The passenger inside the elevator will not feel any gravitational pull, which then it is interpreted as formal analogue that '*inertial acceleration equals to gravitational acceleration*' (Equivalence Principle). More recent experiments (after Eotvos) suggest, however, that this principle only holds at certain conditions.

Further problem may arise if we ask: what if the elevator also experiences lateral rotation around its vertical axis? Does it mean that the inertial acceleration will be slightly higher or lower than gravitational pull? Similarly we observe that a disc rotating at high speed will exert out-of-plane field resemble an acceleration field. All of this seems to indicate that the thought-experiment which forms the basis of general relativity is only applicable for

some limited conditions, in particular the  $F = m \cdot \frac{dv}{dt}$  part (because general relativity is strictly related to Newtonian potential), but it may not be able to represent the *rotational aspects of gravitational phenomena*. Einstein himself apparently recognizes this limitation [8a, p.61]:

"all bodies of reference K' should be given preference in this sense, and they should be exactly equivalent to K for the formation of natural laws, provided that they are in a state of *uniform rectilinear*

\*To appear at *Progress in Physics* 3 Vol. 1 (Jan. 2007) [www.ptep-online.com](http://www.ptep-online.com)

and non-rotary motion with respect to K.” (Italic original by Einstein).

Therefore, it shall be clear that the restriction of *non-rotary motion* remains a limitation for all considerations by relativity theory, albeit the *uniform rectilinear* part has been relaxed by general relativity theory.

After further thought, it becomes apparent that it is required to consider a new kind of metric which may be able to represent the rotational aspects of gravitation phenomena, and by doing so extends the domain of validity of general relativity theory.

In this regard, the present paper will discuss the aforementioned Pioneer blueshift anomaly from the viewpoint of Q-relativity physics, which has been proposed by Yefremov [2] in order to bring into application the quaternion number. Despite the use of quaternion number in physical theories is very scarce in recent years –apart of Pauli matrix-, it has been argued elsewhere that using quaternion number one could expect to unify all known equations in quantum mechanics into the same framework, in particular via the known isomorphism between Dirac equation and Maxwell equations. [5]

Another problem that was often neglected in most treatises on Pioneer spacecraft anomaly is the plausible role of *aether drift* effect.[6] Here it can be shown that taking this effect into consideration along with the aforementioned Q-relativity satellite’s apparent shift could yield numerical prediction of Pioneer blueshift within ~0.26% error range, which speaks for itself.

We also suggest a new kind of Doppler frequency shift which can be predicted using Nottale-type gravitational Bohr-radius, by taking into consideration varying G parameter as described by Moffat [7]. To our knowledge this proposition of new type of redshift corresponding to gravitational Bohr-radius has never been considered before elsewhere.

Further observation is of course recommended in order to verify or refute the propositions outlined herein.

### Some novel aspects of Q-relativity physics. Pioneer blueshift anomaly

In this section, first we will review some basic concepts of quaternion number and then discuss its implications to quaternion relativity (Q-relativity) physics [2]. Then we discuss Yefremov’s calculation of satellite time-shift which may be observed by precise measurement [3]. We however introduce a new interpretation here that such a satellite Q-timeshift is already observed in the form of Pioneer spacecraft blueshift anomaly.

Quaternion number belongs to the group of “very good” algebras: of real, complex, quaternion, and octonion [2]. While Cayley also proposed new terms such as quantic, it is less known than the above group. Quaternion number can be viewed as an extension of Cauchy imaginary plane to become [2]:

$$Q \equiv a + bi + cj + dk . \quad (1)$$

Where a,b,c,d are real numbers, and i,j,k are imaginary quaternion units. These Q-units can be represented either via 2x2 matrices or 4x4 matrices [2].

It is interesting to note here that there is quaternionic multiplication rule which acquires compact form:

$$1q_k = q_k 1 = q_k , \quad q_j q_k = -\delta_{jk} + \varepsilon_{jkn} q_n , \quad (2)$$

Where  $\delta_{kn}$  and  $\varepsilon_{jkn}$  represents 3-dimensional symbols of Kronecker and Levi-Civita, respectively [2]. Therefore it could be expected that Q-algebra may have neat link with pseudo-Riemann metric used by general relativity. Interestingly, it has been argued in this regard that such Q-units can be generalised to become Finsler geometry, in particular with Berwald-Moor metric. It also can be shown that Finsler-Berwald-Moor metric is equivalent

with pseudo-Riemann metric, and an expression of Newtonian potential can be found for this metric [2a]. And with regard to peculiar aspects of Berwald-Moor metric which uses fourth root of quartic differential, perhaps it is worth to quote here from Riemann himself [2b]:

“in which line-element may be expressed as the fourth root of a quartic differential expression.”

It may also be worth noting here that in 3D space Q-connectivity has clear geometrical and physical treatment as movable Q-basis with behaviour of Cartan 3-frame [2].

It is also possible to write the dynamics equations of classical mechanics for an inertial observer in constant Q-basis. SO(3,R)-invariance of two vectors allow to represent these dynamics equations in Q-vector form [2]:

$$m \frac{d^2}{dt^2} (x_k q_k) = F_k q_k. \quad (3)$$

Because of antisymmetry of the connection (generalised angular velocity) the dynamics equations can be written in vector components, by conventional vector notation [2]:

$$m(\vec{a} + 2\vec{\Omega} \times \vec{v} + \vec{\Omega} \times \vec{r} + \vec{\Omega} \times (\vec{\Omega} \times \vec{r})) = \vec{F} \quad (4)$$

Therefore, from equation (4) one recognizes known types of classical acceleration, i.e. linear, coriolis, angular, centripetal, respectively. Meanwhile it is known that the general relativity introduces Newton potential as *rigid* requirement [2a][6b]. In other words, we can expect -- using Q-relativity -- to predict new effects that cannot be explained with general relativity.

From this viewpoint one may consider a generalisation of Minkowski metric into biquaternion form [2]:

$$dz = (dx_k + idt_k) q_k, \quad (5)$$

With some novel properties, i.e.:

- temporal interval is defined by imaginary vector;
- space-time of the model appears to have six dimensions (6D);
- vector of the displacement of the particle and vector of corresponding time change must always be normal to each other, or:

$$dx_k dt_k = 0. \quad (6)$$

It is perhaps quite interesting to note here that Einstein himself apparently once considered similar approach, by proposing tensors with Riemann metric with Hermitian symmetry [8]. Nonetheless, there is difference with Q-relativity described above, because in Einstein's generalised Riemann metric it has 8-dimensions, rather than 3d-space and 3d-imaginary time.

One particularly interesting feature of this new Q-relativity (or rotational relativity) is that there is universal character of motion of the bodies (including non-inertial motions), which can be described in unified manner (Hestenes also considers classical mechanics from similar spinor language). For instance advanced perihelion of planets can be described in terms of such rotational precession. [2]

Inspired by this new Q-relativity physics, it can be argued that there should be anomalous effect in planets' satellite motion. In this regard, Yefremov argues that there should be a deviation of the planetary satellite position, due to discrepancy between calculated and observed from the Earth motion magnitudes characterizing cyclic processes on this planet or near it. He proposes [2]:

$$\Delta\varphi \approx \frac{\omega V_e V_p}{c^2} t, \quad (7)$$

Or

$$\Delta\varphi' \approx -\frac{\omega V_e V_p}{c^2} t'. \quad (8)$$

Therefore, given a satellite orbit radius  $r$ , its position shift is found in units of length  $\Delta l = r \Delta\varphi$ . His calculation for satellites of Mars and Jupiter is given in Table 1. Nonetheless he gave no indication as to how to observe this anomalous effect.

Table 1. The following table gives values of the effect for five fast satellites of Mars and Jupiter. Orbital linear velocities are: of the Earth  $V_E = 29.8$  km/s, of Mars  $V_P = 24.1$  km/s, of Jupiter  $V_P = 13.1$  km/s; value of light velocity is  $c = 299\,793$  km/s; observation period is chosen 100 years. (after A. Yefremov, 2006 [3])

Satellites	Cycle frequency $\omega$ : 1/s	Angular shift $\Delta\varphi$ : "/100 yrs	Linear shift $\Delta l$ : km/100yrs	Linear size $a$ : km
Phobos (Mars)	0.00023	18.2	54	20
Deimos (Mars)	0.00006	4.6	34	12
Metis (Jupiter/J)	0.00025	<b>10.6</b>	431	40
Adrastea (J)	0.00024	<b>10.5</b>	429	20
Amalthea (J)	0.00015	6.3	361	189

In this regard, we introduce here an alternative interpretation of the aforementioned Q-satellite time-shift effect by Yefremov, i.e. this effect actually has similar effect with Pioneer spacecraft blueshift anomaly. It is known that Pioneer spacecraft exhibits this anomalous Doppler frequency while entering Jupiter orbit [1][4], therefore one may argue that this effect is caused by Jupiter planetary gravitational effect, which also may cause similar effect to its satellites. (Interestingly, we may also note that Pioneer spacecraft *was* intended to study more closely the various aspects of Jupiter).

Despite the apparent contradiction with Yefremov's own intention, one could find that the aforementioned Q-satellite time-shift could yield a natural explanation of Pioneer spacecraft blueshift anomaly. In this regard, Taylor [9] argues that there is possibility of a mundane explanation of anomalous blueshift of Pioneer anomaly ( $5.99 \times 10^{-9}$  Hz/sec). The all-angle formula for relativistic Doppler shift is given by [9a, p.34]:

$$v' = v_0 \frac{(1 - \beta \cos \phi)}{\sqrt{1 - \beta^2}}, \quad (9)$$

Where  $\beta = v/c$ . Or using the relativistic term  $\gamma = 1/\sqrt{1-\beta^2}$ , one gets the standard expression:

$$v' = v_0 \gamma (1 - \beta \cos \phi). \quad (9a)$$

The derivative with respect to  $\phi$  is:

$$\frac{dv'}{d\phi} = v_0 \gamma \beta \sin \phi, \quad (10)$$

Where  $\frac{dv'}{d\phi} = 5.99 \times 10^{-9}$  Hz/sec, i.e. the observed Pioneer anomaly. Introducing this value into equation (10), one gets requirement of an effect to explain Pioneer anomaly:

$$d\phi = \arcsin(5.99 \times 10^{-9} \text{ Hz})(v_0 \gamma \beta)^{-1} = 1.4 \times 10^{-12} \text{ degree/sec}. \quad (11)$$

Therefore, we can conclude that to explain  $5.99 \times 10^{-9}$  Hz/sec blueshift anomaly, it is required to find a shift of emission angle at the order  $1.4 \times 10^{-12}$  degree/sec only (or around 15.894" per 100 years).

Interestingly this angular shift can be explained with the same order of magnitude from the viewpoint of Q-satellite angular shift (see Table 1), in particular for Jupiter's Adrastea (10.5" per 100 years). There is however, a large discrepancy at the order of 50% from the expected angular shift.

It is proposed here that such discrepancy between Q-satellite angular shift and expected angular shift required to explain Pioneer anomaly can be reduced if we take into consideration the 'aether drift' effect [6]. Interestingly we can use experimental result of Thorndike [6, p.9], saying that the aether drift effect implies a residual apparent Earth velocity is  $v_{\text{obs}} = 15 \pm 4$  km/sec. Therefore the effective  $V_e$  in equation (8) becomes:

$$V_{e,\text{eff}} = v_{\text{obs}} + V_e = 44.8 \text{ km/sec}. \quad (12)$$

Using this improved value for Earth velocity in equation (8), one will get larger values than Table 1, which for Adrastea satellite yields:

$$\Delta\phi_{\text{obs}} = \frac{\omega V_{e,\text{eff}} V_p}{c^2} t = \frac{V_{e,\text{eff}}}{V_e} \Delta\phi = 15.935''/100 \text{ yrs}. \quad (13)$$

Using this improved prediction, the discrepancy with required angular shift only (15.894" per 100 years) becomes  $\sim 0.26\%$ , which speaks for itself. Therefore one may conclude that this less mundane explanation of Pioneer blueshift anomaly with Q-relativity may deserve further consideration.

### A new type of redshift from gravitational Bohr radius. Possible observation in solar system.

In preceding paper [10][11] we argued in favour of an alternative interpretation of Tiffit redshift quantization from the viewpoint of quantized distance between galaxies. A method can be proposed as further test of this proposition both at solar system scale or galaxies scale, by using the known quantized Tiffit redshift [14][15][16]:

$$\delta r \approx \frac{c}{H} \delta z \quad (14)$$

In this regards, we use gravitational Bohr radius equation [10][11]:

$$r_n = n^2 \frac{GM}{v_o^2} \quad (15)$$



Inserting equation (15) into (14), then one gets quantized redshift expected from gravitational Bohr radius:

$$z_n = \frac{H}{c} n^2 \frac{GM}{v_o^2} \quad (16)$$

Which can be observed either in solar system scale or galaxies scale. To our present knowledge, this effect has never been described elsewhere before.

Therefore, it is recommended to observe such an accelerated Doppler-frequency shift, which for big jovian planets this effect may be detected. It is also worth noting here that according to equation (16), this new Doppler shift is quantized.

At this point one may also take into consideration a proposition by Mof-fat, regarding modification of Newtonian acceleration law to become [7]:

$$a(r) = -\frac{G_\infty M}{r^2} + K \frac{\exp(-\mu_\phi r)}{r^2} (1 + \mu_\phi r) \quad (17)$$

Where

$$G_\infty = G \left[ 1 + \sqrt{\frac{M_0}{M}} \right] \quad (17a)$$

Therefore equation (16) may be rewritten to become:

$$z_n \approx \frac{H}{c} n^2 \frac{GM}{v_o^2} \left[ 1 + \sqrt{\frac{M_0}{M}} \right] \approx \chi \cdot \frac{H}{c} n^2 \frac{GM}{v_o^2} \quad (18)$$

where n is integer (1,2,3...) and:

$$\chi = \left[ 1 + \sqrt{\frac{M_0}{M}} \right] \quad (18a)$$

To use the above equations, one may start by using Bell's suggestion that there is fundamental redshift  $z=0.62$  which is typical for various galaxies and quasars [14]. Assuming we can use equation (16), then by setting  $n=1$ , we can expect to predict the mass of quasar centre or galaxy centre. Then the result can be used to compute back how time-variation parameter affects redshift pattern in equation (18). In solar system scale, time-varying radius may be observed in the form of changing Astronomical Unit [4].

This proposition, however, deserves further theoretical considerations. Further observation is also recommended in order to verify and explore further this proposition.

### Concluding remarks

In the present paper it is argued that Pioneer anomalous blueshift may be caused by Pioneer spacecraft experiencing angular shift induced by similar Q-relativity effect which may also affect Jupiter satellites. By taking into consideration aether drift effect, the proposed method as described herein could predict Pioneer blueshift within ~0.26% error range, which speaks for itself. Further observation is of course recommended in order to refute or verify this proposition.

Another new proposition of redshift quantization is also proposed from gravitational Bohr-radius which is consistent with Bohr-Sommerfeld quantization. It is recommended to conduct further observation in order to verify

and also to explore various implications of our propositions as described herein.

### **Acknowledgment**

The writers would like to thank to Profs. C. Castro, and D.L. Rapoport for valuable discussions. Special thanks to D. Rabounski, S. Crothers, L. Borissova, and also to Prof. A. Yefremov for sending his recent calculation of Jupiter satellite's Q-time-shift effect.

## References

- [1] Anderson, J.D., J.K. Campbell, & M.M. Nieto, arXiv:astro-ph/0608087 (2006). [1a] M.M. Nieto & J.D. Anderson, gr-qc/0507052 (2005). [1b] Jaekel, M., & S. Reynaud, "Radar ranging and Doppler tracking in *post-Einsteinian* metric theories of gravity," arXiv:gr-qc/0610155 (2006).
- [2] Yefremov, A., "Quaternions: Algebra, Geometry and physical theories," *Hypercomplex numbers in Geometry and Physics* 1(1) p.105 (2004); [2a] Pavlov, D.G., arXiv:math-ph/0609009 (2006); [2b] B. Riemann, *Nature* Vol. VIII Nos. 183, 184, p.14-17, 36, 37. Translated by William K. Clifford.
- [3] Yefremov, A., communication via email, [a.yefremov@rudn.ru](mailto:a.yefremov@rudn.ru), (Oct. 2006)
- [4] Laemmerzahl, C., & H. Dittus, *Clocks and Gravity*, From Quantum to Cosmos, (2006) [www.physics.ucla.edu/quantum\\_to\\_cosmos/q2c06/Laemmerzahl.pdf](http://www.physics.ucla.edu/quantum_to_cosmos/q2c06/Laemmerzahl.pdf)
- [5] Christianto, V., *EJTP* Vol. 3 No. 12 (Oct. 2006), <http://www.ejtp.com>
- [6] Consoli, M., arXiv:physics/0306094 (2003) p.9, [6a] Consoli, M. *et al*, arXiv:gr-qc/0306105 (2003); [6b] arXiv:hep-ph/0109215 (2001).
- [7] Moffat, J., arXiv:astro-ph/0602607 (2006).
- [8] Einstein, A., "Generalised theory of gravitation," *Ann. Math.* 46 (1945)  
; [8a] Einstein, A., *Relativity: The special and the general theory*, Crown Trade Paperback, New York, translation by R. Lawson (1951) p. 61, 66-70. With regards to his Generalised Theory of Gravitation [8], it is perhaps worth to quote here his confident tone in remarks at the end of his book [8a]: "After long probing I believe that I have now found the most natural form for this generalisation, but I have not yet been able to find out whether this generalised law can stand up against the facts of experience". (Appendix V, p. 156).
- [9] Taylor, S., "Hypothesis of a Mundane solution of the Pioneer anomaly," arXiv:physics/0603074 (2006); [9a] Engelhardt, W., *Apeiron* Vol. 10 No. 4 (2003) p.34.
- [10] Smarandache, F., & V. Christianto, 'A note on geometric and information fusion interpretation of Bell theorem and quantum measurement,' *Progress in Physics* Vol.2 No. 4 (2006), <http://www.ptep-online.com>
- [11] Smarandache, F., & V. Christianto, 'Plausible explanation of quantization of intrinsic redshift from Hall effect and Weyl quantization,' *Progress in Physics* Vol.2 No. 4 (2006), <http://www.ptep-online.com>
- [12] Smarandache, F., & V. Christianto, *Progress in Physics* Vol.2 No. 2 (Apr. 2006), <http://www.ptep-online.com>
- [13] Fischer, U., arXiv:cond-mat/9907457 (1999); [13a] arXiv:cond-mat/0004339
- [14] Bell, M.B., arXiv: astro-ph/0111123 (2001); [14a] Bell, M.B., [http://arxiv.org/PS\\_cache/astro-ph/pdf/0305/0305112.pdf](http://arxiv.org/PS_cache/astro-ph/pdf/0305/0305112.pdf); [14b] Bell, M.B., arXiv: astro-ph/0305060 (2003).
- [15] Humphreys, R, *TJ Archive* Vol.16 <http://answersingenesis.org/tj/v16/i2/> (2002) [http://www.answersingenesis.org/home/area/magazines/tj/docs/TJv16n2\\_CEN\\_TRE.pdf](http://www.answersingenesis.org/home/area/magazines/tj/docs/TJv16n2_CEN_TRE.pdf); [15a] Setterfield, B., [www.journaloftheoretics.org](http://www.journaloftheoretics.org)
- [16] Munera, H., "Redshift in absolute space," *Apeiron* Vol. 5 No.3-4, July. (1998)
- [17] Zurek, W. (ed.), in *Proc. Euroconference in Formation and Interaction of Topological Defects*, Plenum, 1995, arXiv :cond-mat/9502119 (1995).
- [18] Volovik, G., arXiv:cond-mat/0507454 (2005).

*First version: 7<sup>th</sup> Nov. 2006. 1<sup>st</sup> revision 23<sup>rd</sup> Jan. 2006*

# A note on unified statistics including Fermi-Dirac, Bose-Einstein, and Tsallis statistics, and plausible extension to anisotropic effect

V. Christianto<sup>1</sup> & F. Smarandache<sup>2</sup>

<sup>1</sup>. <http://www.sciprint.org>, email: [admin@sciprint.org](mailto:admin@sciprint.org)

<sup>2</sup>. Dept. of Mathematics, Univ. of New Mexico, Gallup

In the light of some recent hypotheses suggesting plausible unification of thermo-statistics where Fermi-Dirac, Bose-Einstein and Tsallis statistics become its special subsets, we consider further plausible extension to include non-integer Hausdorff dimension, which becomes realization of fractal entropy concept.

In the subsequent section, we also discuss plausible extension of this unified statistics to include anisotropic effect by using quaternion oscillator, which may be observed in the context of Cosmic Microwave Background Radiation. Further observation is of course recommended in order to refute or verify this proposition.

## Introduction

In recent years, there have been some hypotheses suggesting that the spectrum and statistics of Cosmic Microwave Background Radiation has a kind of *scale invariant* character [1], which may be related to non-integer Hausdorff dimension. Interestingly, in this regard there is also proposition sometime ago suggesting that Cantorian spacetime may have deep link with Bose condensate with non-integer Hausdorff dimension [2]. All of these seem to indicate that it is worth to investigate further the non-integer dimension effect of Bose-Einstein statistics, which in turn may be related to Cosmic Microwave Background Radiation spectrum.

In the meantime, some authors also consider a plausible generalization of known statistics, i.e. Fermi-Dirac, Bose-Einstein, and Tsallis statistics, to become more unified statistics [3][4]. This attempt can be considered as one step forward from what is already known, i.e. to consider anyons as a generalization of bosons and fermions in two-dimensional systems.[5, p.2] Furthermore, it is known that superfluidity phenomena can also be observed in Fermi liquid [6].

First we will review the existing procedure to generalize Fermi-Dirac, Bose-Einstein, and Tsallis statistics, to become more unified statistics [3][4]. And then we explore its plausible generalization to include fractality of Tsallis' non-extensive entropy parameter.

In the subsequent section, we also discuss plausible extension of this proposed unified statistics to include anisotropic effect, which may be observed in the context of Cosmic Microwave Background Radiation. In particular we consider possibility to introduce quaternionic momentum. To our knowledge this proposition has never been considered before elsewhere.

Further observation is of course recommended in order to verify or refute the propositions outlined herein.

## Unified statistics including Fermi-Dirac, Bose-Einstein, and Tsallis statistics.

In this section we consider a different theoretical framework to generalize Fermi-Dirac and Bose-Einstein statistics, from conventional method using anyons, [5] in particular because this conventional method cannot be generalized further to include Tsallis statistics which has attracted some attention in recent years.

First we write down the standard expression of Bose distribution [9, p.7]:

$$\bar{n}(\epsilon_i) = \frac{1}{\exp(\beta(\epsilon_i - \mu)) - 1}, \quad (1)$$

Where the harmonic energy levels are given by [9, p.7]:

$$\epsilon_i = (n_x + n_y + n_z + \frac{3}{2})\hbar\omega_0. \quad (2)$$

When we assume that bosons and fermions are g-ons obeying fractional exclusion statistics, then we get a very different picture. In accordance with [3], we consider the spectrum of fractal dimension (also called *generalized Renyi dimension* [11]):

$$D_q = \lim_{\delta \rightarrow 0} \frac{1}{q-1} \frac{\ln \Omega_q}{\ln \delta}, \quad (3)$$

(therefore the spectrum of fractal dimension is equivalent with Hausdorff dimension of the set A [11]).

Then the relation between the entropy and the spectrum of fractal dimension is given by: [3]

$$S_q = -k_B \cdot \lim_{\delta \rightarrow 0} \ln \delta D_q, \quad (4)$$

Where  $k_B$  is the Boltzmann constant. The spectrum of fractal dimension may be expressed in terms of p:

$$D_q \approx \frac{1}{q-1} \frac{\sum_{i=1}^K p_i^q - 1}{\ln \delta}. \quad (5)$$

Then, substituting equation (5) into (4), we get the Tsallis non-extensive entropy [3]:

$$S_q = -k_B \cdot \frac{\sum_{i=1}^K p_i^q - 1}{q-1}, \quad (6)$$

After a few more assumptions, and using g-on notation [3], i.e. g=1 for generalized Fermi-Dirac statistics and g=0 for generalised Bose-Einstein statistics, then one gets the most probable distribution for g-ons [3]:

$$\bar{n}_k(\epsilon_i, g, q) = \frac{1}{(1 - (q-1)\beta(\epsilon_i - \mu))^{\frac{1}{q-1}} + 2g - 1}, \quad (7)$$

Which gives standard Planck distribution for  $\mu=0$ ,  $g=0$  and  $q=1$ . [3][9] In other words, we could expect that g-ons gas statistics could yield more generalized statistics than anyons'.

To introduce further generality of this expression (7), one may consider the parameter q as function of another non-integer dimension, therefore:

$$\bar{n}_k(\epsilon_i, g, q, D) = \frac{1}{(1 - (q^D - 1)\beta(\epsilon_i - \mu)) \frac{1}{q^{D-1}} + 2g - 1}, \quad (8)$$

Where D=1, then equation (8) reduces to be (7).

Of course, the picture described above will be different if we introduce non-standard momentum [5, p.7]:

$$p^2 = -\frac{d^2}{dx^2} + \frac{\lambda}{x^2} \quad (9)$$

In the context of Neutrosophic logic as conceived by one of these writers [8], one may derive a proposition from the arguments presented herein, i.e. apart from common use of anyons as a plausible generalization of fermion and boson, perhaps an alternative method for generalization of fermion and boson can be described as follows:

- (a) If we denote fermion with (f) and boson with (b), then it follows that there could be a mixture composed of both (f) and (b)  $\rightarrow$  (f)  $\cap$  (b), which may be called as ‘anyons’;
- (b) If we denote fermion with (f) and boson with (b), and because g=1 for generalized Fermi-Dirac statistics and g=0 for generalised Bose-Einstein statistics, then it follows that the wholeness of both (f) and (b)  $\rightarrow$  (f)  $\cup$  (b), which may be called as ‘g-on’;
- (c) Taking into consideration of possibility of ‘neitherness’, then if we denote non-fermion with ( $\neg$ f) and non-boson with ( $\neg$ b), then it follows that there shall be a mixture composed of both ( $\neg$ f) and ( $\neg$ b)  $\rightarrow$  ( $\neg$ f)  $\cap$  ( $\neg$ b), which may be called as ‘feynmion’ (after physicist the late R. Feynman);
- (d) Taking into consideration of possibility of ‘neitherness’, then it follows that the wholeness of both ( $\neg$ f) and ( $\neg$ b)  $\rightarrow$  ( $\neg$ f)  $\cup$  ( $\neg$ b), which may be called as ‘anti-g-on’.

Therefore, a conjecture which may follow from this proposition is that perhaps in the near future we can observe some new entities corresponding to g-on condensate or feynmion condensate.

**Further extension to include anisotropic effect.**

At this section we consider the anisotropic effect which may be useful for analyzing the anisotropy of CMBR spectrum, see Fig 1 [13]:

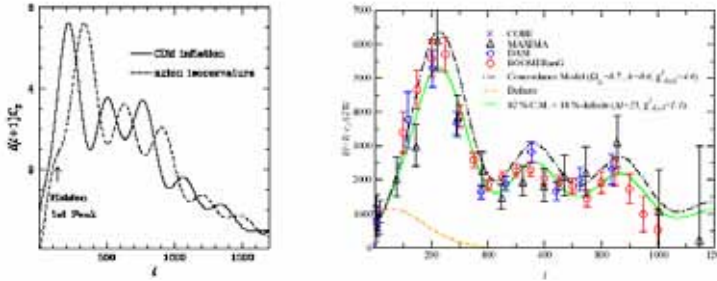

Fig. 7: Left panel: comparison of CMB power spectra in the models with adiabatic and isocurvature initial perturbations, from Ref. [30]. Right panel: adiabatic power spectra in comparison with spectra appearing in models seeded by topological defects, from Ref. [31]. In this panel some older, pre-WMAP, data are also shown.

Fig 1. Anisotropy of CMBR (After Tkachev [13]).

For anisotropic case, one cannot use again equation (2), but shall instead use [7, p2]:

$$\epsilon_i = (n_x + \frac{1}{2})\hbar\omega_x + (n_y + \frac{1}{2})\hbar\omega_y + (n_z + \frac{1}{2})\hbar\omega_z, \quad (10)$$

Where  $n_x, n_y, n_z$  are integers and  $>0$ . Or by neglecting the  $\frac{1}{2}$  parts and assuming a common frequency, one can re-write (10) as [7a, p1]:

$$\epsilon_i = (n_x r + n_y s + n_z t)\hbar\omega_0, \quad (11)$$

Where  $r, s, t$  is multiplying coefficient for each frequency:

$$r = \frac{\omega_x}{\omega_0}, s = \frac{\omega_y}{\omega_0}, t = \frac{\omega_z}{\omega_0} \quad (12)$$

This proposition will yield a different spectrum compared to isotropic spectrum by assuming isotropic harmonic oscillator (2). See Fig 2 [7a]. It is interesting to note here that the spectrum produced by anisotropic frequencies yields number of peaks more than 1 (multiple-peaks), albeit this is not near yet to CMBR spectrum depicted in Fig 1. Nonetheless, it seems clear here that one can expect to predict the anisotropy of CMBR spectrum by using of more anisotropic harmonic oscillators.

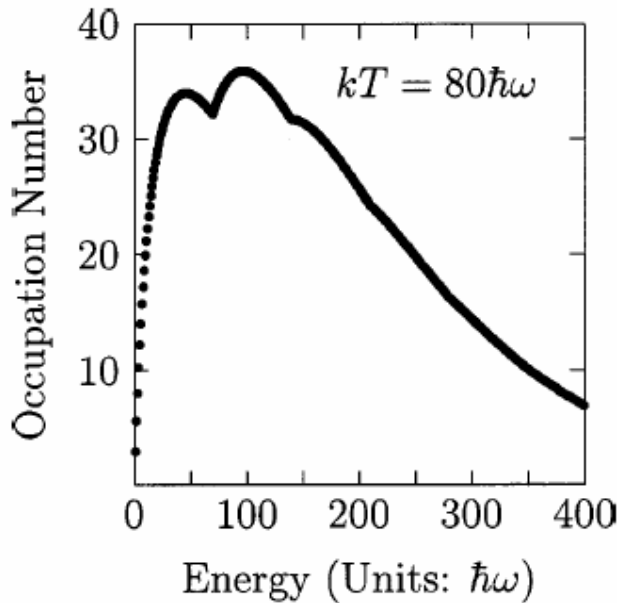

Fig. 2 Spectrum for anisotropic harmonic oscillator potential.  
(After Ligare [7a])

In this regard, it is interesting to note that some authors considered half quantum vortices in  $p_x+i.p_y$  superconductors [14], which indicates that energy of partition function may be generalized to include Cauchy plane, because:

$$E = p.c + i.p.c \approx \hbar\omega + i\hbar\omega, \quad (13)$$

or by generalizing this Cauchy plane to quaternion number [12], one gets instead of (13):

$$E_{qk} = \hbar\omega + i\hbar\omega + j\hbar\omega + k\hbar\omega, \quad (14)$$

Which is similar to standard definition of quaternion number:

$$Q \equiv a + bi + cj + dk, \quad (15)$$

Therefore the partition function with anisotropic harmonic potential can be written in quaternion form. Therefore instead of (11), we get:

$$\epsilon_i = (n_x r + n_y s + n_z t + i n_x r + j n_y s + k n_z t) \hbar\omega_0, \quad (16)$$

Which can be written as:

$$\epsilon_i = (1 + q_k)(n_k r_k) \hbar\omega_0, \quad (17)$$

Where  $k=1,2,3$  corresponding to index of quaternion number  $i,j,k$ . While we don't obtain numerical result here, it can be expected that this generalisation to anisotropic quaternion harmonic potential could yield better prediction, which perhaps may yield to exact CMBR spectrum. Numerical solution of this problem may be presented in another paper.

This proposition, however, deserves further considerations. Further observation is also recommended in order to verify and explore further this proposition.

### Concluding remarks

In the present paper, we review an existing method to generalize Fermi-Dirac, Bose-Einstein, and Tsallis statistics, to become more unified statistics. And then we explore its plausible generalization to include fractality of Tsallis non-extensive entropy parameter.

Therefore, a conjecture which may follow this proposition is that perhaps in the near future we can observe some new entities corresponding to g-on condensate or feynmion condensate.

In the subsequent section, we also discuss plausible extension of this proposed unified statistics to include anisotropic effect, which may be observed in the context of Cosmic Microwave Background Radiation. In particular we consider possibility to introduce quaternionic momentum. To our knowledge this proposition has never been considered before elsewhere.

It is recommended to conduct further observation in order to verify and also to explore various implications of our propositions as described herein.

### Acknowledgment

The writers would like to thank to Profs. C. Castro, A. Yefremov and D.L. Rapoport for valuable discussions. And special thanks to D. Rabounski, S. Crothers, L. Borissova,



## References

- [1] Antoniadis, I., *et al.*, arXiv:astro-ph/9611208 (1996).
- [2] Castro, C., & A., Granik, “Why we live in 3 dimensions,” arXiv:hep-th/0004152 (2000).
- [3] Buyukkilic, F., & D. Demirhan, arXiv:hep-th/0010192 (2001)
- [4] Utyuzh, O.V., *et al.*, arXiv:hep-ph/9910355 (1999)
- [5] Leinaas, J.M., arXiv:hep-th/9611167 (1996) p.2.
- [6] Pinilla, M.R., *Signatures of superfluidity in atomic Fermi gases*, Diss. Helsinki University of Tech. (Nov. 2003) 72 p.
- [7] Ligare, M., “Numerical analysis of Bose-Einstein condensation in a three dimensional harmonic oscillator potential,” *Am. J. Phys.* 66 No. 3 (1998) p.2; [7a] M. Ligare, *Am. J. Phys.* 70 No. 1 (2002).
- [8] Smarandache, F., & V. Christianto, *Progress in Physics* Vol.2 No. 4 (Oct. 2006), <http://www.ptep-online.com>
- [9] Griffin, A., arXiv:cond-mat/9911419 (1999) p.7.
- [10] Tuszynski, J., *et al.*, *Physica A* 325 (2003) 455-476 (<http://sciencedirect.com>)
- [11] Batunin, F., *Physics-Uspokhi* 38(6) 609-623 (1995)
- [12] Yefremov, A., “Relativistic Oscillator in Quaternion Relativity,” in this volume (Nov. 2006).
- [13] Tkachev, I., arXiv:hep-ph/0405168 (2004) p. 17-18.
- [14] Stone, M., *et al.*, arXiv:cond-mat/0505515 (2005) p. 14-15.

*First version: 8<sup>th</sup> Jan. 2007.*

# Numerical solution of Time-dependent gravitational Schrödinger equation\*

V. Christianto<sup>1</sup>, D.L. Rapoport<sup>2</sup> & F. Smarandache<sup>3</sup>

<sup>1</sup>. <http://www.sciprint.org>, email: [admin@sciprint.org](mailto:admin@sciprint.org)

<sup>2</sup>. Dept. of Sciences and Technology, Univ. Nac. de Quilmes, Bernal, Argentina

<sup>3</sup>. Dept. of Mathematics, Univ. of New Mexico, Gallup

In recent years, there are attempts to describe quantization of planetary distance based on time-independent gravitational Schrödinger equation, including Rubcic & Rubcic's method and also Nottale's Scale Relativity method. Nonetheless, there is no solution yet for time-dependent gravitational Schrödinger equation (TDGSE). In the present paper, a numerical solution of time-dependent gravitational Schrödinger equation is presented, apparently for the first time. This numerical solution leads to gravitational Bohr-radius, as expected.

In the subsequent section, we also discuss plausible extension of this gravitational Schrödinger equation to include the effect of phion condensate via Gross-Pitaevskii equation, as described recently by Moffat. Alternatively one can consider this condensate from the viewpoint of Bogoliubov-deGennes theory, which can be approximated with coupled time-independent gravitational Schrödinger equation. Further observation is of course recommended in order to refute or verify this proposition.

## Introduction

In the past few years, there have been some hypotheses suggesting that quantization of planetary distance can be derived from a gravitational-Schrödinger equation, such as Rubcic & Rubcic and also Nottale's scale relativity method [1][3]. Interestingly, the gravitational Bohr radius derived from this gravitational Schrödinger equation yields prediction of new type of astronomical observation in recent years, i.e. extrasolar planets, with unprecedented precision [2].

Furthermore, as we discuss in preceding paper [4], using similar assumption based on gravitational Bohr radius, one could predict new planetoids in the outer orbits of Pluto which apparently in good agreement with recent observational finding. Therefore one could induce from this observation that the gravitational Schrödinger equation (and gravitational Bohr radius) deserves further consideration.

In the meantime, it is known that all present theories discussing gravitational Schrödinger equation only take its time-independent limit. Therefore it seems worth to find out the solution and implication of time-dependent gravitational Schrödinger equation (TDGSE). This is what we will discuss in the present paper.

First we will find out numerical solution of time-independent gravitational Schrödinger equation which shall yield gravitational Bohr radius as expected [1][2][3]. Then we extend our discussion to the problem of time-dependent gravitational Schrödinger equation.

In the subsequent section, we also discuss plausible extension of this gravitational Schrödinger equation to include the effect of phion condensate via Gross-Pitaevskii equation, as described recently by Moffat [5]. Alternatively one can consider this condensate from the viewpoint of Bogoliubov-deGennes theory, which can be approximated with coupled time-independent gravitational Schrödinger equation. To our knowledge this proposition of coupled time-independent gravitational Schrödinger equation

\*Submitted to *Progress in Physics* (Jan. 2007) [www.ptep-online.com](http://www.ptep-online.com)

has never been considered before elsewhere. Further extension to time-dependent case is straightforward.

Further observation is of course recommended in order to verify or refute the propositions outlined herein.

All numerical computation was performed using Maple. Please note that in all conditions considered here, we use only gravitational Schrödinger equation as described in Rubcic & Rubcic [3], therefore we neglect the Scale relativistic effect for clarity.

### Numerical solution of time-independent gravitational Schrödinger equation and time-dependent gravitational Schrödinger equation.

First we write down the time-independent gravitational Schrödinger radial wave equation in accordance with Rubcic & Rubcic [3]:

$$\frac{d^2 R}{dr^2} + \frac{2}{r} \frac{dR}{dr} + \frac{8\pi m^2 E'}{H^2} R + \frac{2}{r} \frac{4\pi^2 GMm^2}{H^2} R - \frac{\ell(\ell+1)}{r^2} R = 0, \quad (1)$$

When  $H$ ,  $V$ ,  $E'$  represents gravitational Planck constant, Newtonian potential, and the energy per unit mass of the orbiting body, respectively, and [3]:

$$H = h \left( 2\pi \cdot f \frac{Mm_n}{m_o^2} \right), \quad (2)$$

$$V(r) = -\frac{GMm}{r}, \quad (3)$$

$$E' = \frac{E}{m}. \quad (4)$$

By assuming that  $R$  takes the form:

$$R = e^{-\alpha \cdot r} \quad (5)$$

And substituting it into equation (1), and using simplified terms only of equation (1), one gets:

$$\Psi = \alpha^e e^{-\alpha \cdot r} - \frac{2\alpha \cdot e^{-\alpha \cdot r}}{r} + \frac{8\pi GMm^2 e^{-\alpha \cdot r}}{r \cdot H^2}. \quad (6)$$

After factoring this equation (6) and solving it by equating the factor with zero, yields:

$$RR = -\frac{2(4\pi GMm^2 - H^2 \alpha)}{\alpha^2 H^2} = 0. \quad (7)$$

Or

$$RR = 4\pi GMm^2 - H^2 \alpha = 0. \quad (7a)$$

And solving for  $\alpha$ , one gets:

$$\alpha = \frac{4\pi^2 GMm^2}{H^2}. \quad (8)$$

Gravitational Bohr radius is defined as inverse of this solution of  $\alpha$ , then one finds (in accordance with Rubcic & Rubcic [3]):

$$r_1 = \frac{H^2}{4\pi^2 GMm^2}. \quad (9)$$

And by substituting back equation (2) into (9), one gets [3]:

$$r_1 = \left( \frac{2\pi \cdot f}{\alpha \cdot c} \right)^2 GM \quad (10)$$

Which is equivalent with Nottale's result [1][2], especially when we introduce the quantization number:  $r_n = r_1 \cdot n^2$  [3]. For complete Maple session of these steps, see Appendix A.1.

Solution of time-dependent gravitational Schrödinger equation is more or less similar with the above steps, except that we shall take into consideration the right hand side of Schrödinger equation and also assuming time dependent form of  $r$ :

$$R = e^{-\alpha \cdot r(t)}. \quad (11)$$

Therefore the gravitational Schrödinger equation now reads (neglecting  $i$  number in both sides):

$$\begin{aligned} \frac{d^2 R}{dr^2} + \frac{2}{r} \frac{dR}{dr} + \frac{8\pi m^2 E'}{H^2} R + \\ \frac{2}{r} \frac{4\pi^2 GMm^2}{H^2} R - \frac{\ell(\ell+1)}{r^2} R = H \frac{dR}{dt} \end{aligned} \quad (12)$$

Or by using Leibniz chain rule, we can rewrite equation (12) as:

$$\begin{aligned} -H \frac{dR}{dr(t)} \frac{dr(t)}{dt} + \frac{d^2 R}{dr^2} + \frac{2}{r} \frac{dR}{dr} + \frac{8\pi m^2 E'}{H^2} R + \\ \frac{2}{r} \frac{4\pi^2 GMm^2}{H^2} R - \frac{\ell(\ell+1)}{r^2} R = 0 \end{aligned} \quad (13)$$

The remaining steps are similar with the aforementioned procedures for time-independent case, except that now one gets an additional term for  $RR'$ :

$$RR' = H^3 \alpha \left( \frac{d}{dt} r(t) \right) r(t) - \alpha^2 r(t) H^2 + 8\pi GMm^2 - 2H^2 \alpha = 0. \quad (14)$$

At this point one shall assign a value for  $\frac{d}{dt} r(t)$  term, because otherwise the equation cannot be solved. We choose  $\frac{d}{dt} r(t) = 1$  for simplicity, then one gets solution for (14):

$$\begin{aligned} a2 := \{ & \alpha = \alpha, \pi = \pi, m = m, h = h, G = G, M = M, \\ & t = \text{RootOf}(r(\_Z) \alpha h^3 - r(\_Z) \alpha^2 h^2 + 8 \pi^2 G M m^2 - 2 \alpha h^2) \}, \\ & \{ \alpha = 0, t = t, m = m, h = h, G = G, M = M, \pi = 0 \}, \\ & \{ \alpha = 0, \pi = \pi, t = t, m = m, h = h, M = M, G = 0 \}, \\ & \{ \alpha = \alpha, h = 0, t = t, m = m, G = G, M = M, \pi = 0 \}, \\ & \{ \pi = \pi, t = t, m = m, h = h, M = M, \alpha = h, G = \frac{h^3}{4 \pi^2 M m^2} \}, \\ & \{ \alpha = \alpha, h = 0, \pi = \pi, t = t, m = m, M = M, G = 0 \}, \\ & \{ \alpha = 0, \pi = \pi, t = t, m = m, h = h, G = G, M = 0 \}, \\ & \{ \alpha = 0, \pi = \pi, t = t, h = h, G = G, M = M, m = 0 \}, \end{aligned}$$

$$\{\alpha = \alpha, h = 0, \pi = \pi, t = t, m = m, G = G, M = 0\},$$

$$\{\alpha = \alpha, h = 0, \pi = \pi, t = t, G = G, M = M, m = 0\}$$

Therefore one can conclude that there is time-dependent modification factor to conventional gravitational Bohr radius solution. For complete Maple session of these steps, see Appendix A.2

### Gross-Pitaevskii effect. Bogoliubov-deGennes approximation and coupled time-independent gravitational Schrödinger equation.

At this point it seems worthwhile to take into consideration a proposition by Moffat, regarding modification of Newtonian acceleration law due to phion condensate medium, to include Yukawa type potential [5][6]:

$$a(r) = -\frac{G_\infty M}{r^2} + K \frac{\exp(-\mu_\phi r)}{r^2} (1 + \mu_\phi r) \quad (15)$$

Therefore equation (1) can be rewritten to become:

$$\frac{d^2 R}{dr^2} + \frac{2}{r} \frac{dR}{dr} + \frac{8\pi m^2 E'}{H^2} R + \frac{2}{r} \frac{4\pi^2 (GM - K \exp(-\mu_\phi r)(1 + \mu_\phi r))m^2}{H^2} R - \frac{\ell(\ell+1)}{r^2} R = 0 \quad (16)$$

Or by assuming  $\mu = 2\mu_o = \mu_o \cdot r$  for the exponential term, equation (16) can be rewritten as:

$$\frac{d^2 R}{dr^2} + \frac{2}{r} \frac{dR}{dr} + \frac{8\pi m^2 E'}{H^2} R + \frac{2}{r} \frac{4\pi^2 (GM - Ke^{-2\mu_o} (1 + \mu_o r))m^2}{H^2} R - \frac{\ell(\ell+1)}{r^2} R = 0 \quad (17)$$

Then instead of equation (7a), one gets:

$$RR'' = 8\pi G M m^2 - 2H^2 \alpha - 8\pi^2 m^2 K e^{-2\mu_o} (1 + \mu) = 0. \quad (18)$$

Solving this equation will yield a modified gravitational Bohr radius which includes Yukawa effect:

$$r_1 = \frac{H^2}{4\pi^2 (GM - Ke^{-2\mu_o})m^2}. \quad (19)$$

And the modification factor can be expressed as ratio between equation (19) and (9):

$$\chi = \frac{GM}{(GM - Ke^{-2\mu_o})}. \quad (20)$$

For complete Maple session of these steps, see Appendix A.3.

A careful reader may note that this 'Yukawa potential effect' as shown in equation (20) could be used to explain the small discrepancy (around  $\pm 8\%$ ) between the 'observed distance' and the computed distance based on gravitational Bohr radius [4][6a]. Nonetheless, in our opinion such an interpretation remains an open question, therefore it may be worth to explore further.

There is, however, an alternative way to consider phion condensate medium is by introducing coupled Schrödinger equation, which is known as

Bogoliubov-deGennes theory [7]. This method can be interpreted also as generalisation of assumption by Rubcic-Rubcic [3] of subquantum structure composed of positive-negative Planck mass. Therefore, taking this proposition seriously, then one comes to hypothesis that there shall be coupled Newtonian potential, instead of only equation (3).

To simplify Bogoliubov-deGennes equation, we neglect the time-dependent case, therefore the wave equation can be written in matrix form [7, p.4]:

$$[A][\Psi] = 0 \quad (21)$$

Where [A] is 2x2 matrix and  $[\Psi]$  is 2x1 matrix, respectively, which can be represented as follows:

$$Ar := \begin{bmatrix} \frac{8 \pi^2 G M m^2 e^{(-\alpha r)}}{r h^2} & \alpha^2 e^{(-\alpha r)} - \frac{2 \alpha e^{(-\alpha r)}}{r} \\ \alpha^2 e^{(-\alpha r)} - \frac{2 \alpha e^{(-\alpha r)}}{r} & -\frac{8 \pi^2 G M m^2 e^{(-\alpha r)}}{r h^2} \end{bmatrix} \quad (22)$$

And

$$Br := \begin{bmatrix} f(r) \\ g(r) \end{bmatrix} \quad (23)$$

Numerical solution of this matrix differential equation is shown in Appendix A.4. It is clear here that Bogoliubov-deGennes approximation of gravitational Schrödinger equation, taking into consideration phion condensate medium will yield nonlinear effect. This perhaps may explain complicated structure beyond Jovian Planets, such as Kuiper Belt, inner and outer Oort Cloud etc. which of course these structure cannot be predicted by simple gravitational Schrödinger equation [1][2][3]. In turn from the solution of (21) one could expect that there are multitude of celestial objects not found yet in the Oort Cloud.

This proposition, however, deserves further considerations. Further observation is also recommended in order to verify and explore further this proposition.

### Concluding remarks

In the present paper, a numerical solution of time-dependent gravitational Schrödinger equation is presented, apparently for the first time. This numerical solution leads to gravitational Bohr-radius, as expected.

In the subsequent section, we also discuss plausible extension of this gravitational Schrödinger equation to include the effect of phion condensate via Gross-Pitaevskii equation, as described recently by Moffat. Alternatively one can consider this condensate from the viewpoint of Bogoliubov-deGennes theory, which can be approximated with coupled time-independent gravitational Schrödinger equation.

It is recommended to conduct further observation in order to verify and also to explore various implications of our propositions as described herein.

### Acknowledgment

The writers would like to thank to Profs. C. Castro

## References

- [1] Nottale, L., *et al.*, *Astron. Astroph.* 322 (1997) 1018.
- [2] Nottale, L., G. Schumacher, E.T. Lefevre, *Astron. Astroph.* 361 (2000) 379-389, preprint at <http://daec.obspm.fr/users/nottale>
- [3] Rubcic, A., & J. Rubcic, "The quantization of solar like gravitational systems," *Fizika B-7* Vol. 1 No. 1-13 (1998)
- [4] Smarandache, F., & V. Christianto, *Progress in Physics* Vol.2 No. 2 (Apr. 2006), <http://www.ptep-online.com>
- [5] Moffat, J., arXiv:astro-ph/0602607 (2006).
- [6] Smarandache, F., & V. Christianto, *Progress in Physics* Vol.2 No. 4 (Oct. 2006), <http://www.ptep-online.com>; [6a] Christianto, V., *EJTP* Vol. 3 No. 12 (Oct. 2006) 117-144, <http://www.ejtp.com>
- [7] Lundin, N.I., "Microwave induced enhancement of the Josephson DC," Chalmers University of Technology & Gotterborg University report ( ) p. 4-7.
- [8] Griffin, M., arXiv:cond-mat/9911419 (1999).
- [9] Tuszynski, J., *et al.*, *Physica A* 325 (2003) 455-476 (<http://sciencedirect.com>)
- [10] Toussaint, M., arXiv:cs.SC/0105033 (2001).
- [11] Fischer, U., arXiv:cond-mat/9907457 (1999); [8a] arXiv:cond-mat/0004339
- [12] Zurek, W. (ed.), in *Proc. Euroconference in Formation and Interaction of Topological Defects*, Plenum, 1995, arXiv :cond-mat/9502119 (1995).
- [13] Volovik, G., arXiv:cond-mat/0507454 (2005).

*First version: 2<sup>nd</sup> Jan. 2007. 1<sup>st</sup> revision: 21<sup>st</sup> Jan 2007.*

## Appendix A.1. Time-independent gravitational Schrödinger equation

> restart;

> with (linalg);

> R:=exp(-(alpha\*r));

$$R := e^{(-\alpha r)}$$

> D1R:=diff(R,r); D2R:=diff(D1R,r);

$$D1R := -\alpha e^{(-\alpha r)}$$

$$D2R := \alpha^2 e^{(-\alpha r)}$$

>

SCHEQ1:=D2R+D1R\*2/r+8\*pi^2\*m\*E\*R/h^2+8\*pi^2\*G\*M\*m^2\*R/(r\*h^2)-1\*(l+1)\*R/r^2=0;

SCHEQ1 :=

$$\alpha^2 e^{(-\alpha r)} - \frac{2\alpha e^{(-\alpha r)}}{r} + \frac{8\pi^2 m E e^{(-\alpha r)}}{h^2} + \frac{8\pi^2 G M m^2 e^{(-\alpha r)}}{r h^2} - \frac{l(l+1) e^{(-\alpha r)}}{r^2} = 0$$

> XX1:=factor(SCHEQ1);

$$XX1 := \frac{e^{(-\alpha r)} (\alpha^2 r^2 h^2 - 2\alpha r h^2 + 8\pi^2 m E r^2 + 8\pi^2 G M m^2 r - l^2 h^2 - l h^2)}{r^2 h^2} = 0$$

> KK:=solve(XX1,G\*M); AA:=solve(XX1,alpha);

KK :=

$$AA := \frac{h + \sqrt{h^2 + l^2 h^2 + l h^2 - 8\pi^2 m E r^2 - 8\pi^2 G M m^2 r}}{h r},$$

$$\frac{h - \sqrt{h^2 + l^2 h^2 + l h^2 - 8\pi^2 m E r^2 - 8\pi^2 G M m^2 r}}{h r}$$

> #Using simplified terms only from equation (A\*8)

> SCHEQ2:=D2R+D1R\*2/r+8\*pi^2\*G\*M\*m^2\*R/(r\*h^2)=0;

$$SCHEQ2 := \alpha^2 e^{(-\alpha r)} - \frac{2\alpha e^{(-\alpha r)}}{r} + \frac{8\pi^2 G M m^2 e^{(-\alpha r)}}{r h^2} = 0$$



```
> XX2:=factor(SCHEQ2);
```

$$XX2 := \frac{e^{(-\alpha r)} (\alpha^2 r h^2 - 2 h^2 \alpha + 8 \pi^2 G M m^2)}{r h^2} = 0$$

```
> RR:=solve(XX2, r);
```

$$RR := -\frac{2 (4 \pi^2 G M m^2 - h^2 \alpha)}{\alpha^2 h^2}$$

```
> #Then solving for RR=0, yields:
```

```
> SCHEQ3:=4*pi^2*G*M*m^2-h^2*alpha=0;
```

$$SCHEQ3 := 4 \pi^2 G M m^2 - h^2 \alpha = 0$$

```
> a:=solve(SCHEQ3, alpha);
```

$$a := \frac{4 \pi^2 G M m^2}{h^2}$$

```
> #Gravitational Bohr radius is defined as inverse of al-  
pha:
```

```
> gravBohrradius:=1/a;
```

$$gravBohrradius := \frac{h^2}{4 \pi^2 G M m^2}$$

## Appendix A.2. Time-dependent gravitational Schrödinger equation

```
> #Solution of gravitational Schrodinger equation (Rub-
cic, Fizika 1998);
```

```
> restart;
```

```
> #with time evolution (Hagendorn's paper);
```

```
> S:=r(t); R:=exp(-(alpha*S)); R1:=exp(-(alpha*r));
```

$$S := r(t)$$

$$R := e^{(-\alpha r(t))}$$

$$R1 := e^{(-\alpha r)}$$

```
> D4R:=diff(S,t); D1R:= -alpha*exp(-(alpha*S)); D2R:= -
alpha^2*exp(-(alpha*S)); D5R:=D1R*D4R;
```

$$D4R := \frac{d}{dt} r(t)$$

$$D1R := -\alpha e^{(-\alpha r(t))}$$

$$D2R := -\alpha^2 e^{(-\alpha r(t))}$$

$$D5R := -\alpha e^{(-\alpha r(t))} \left( \frac{d}{dt} r(t) \right)$$

```
> #Using simplified terms only from equation (A*8)
```

```
> SCHEQ3:=-h*D5R+D2R+D1R*2/S+8*pi^2*G*M*m^2*R/(S*h^2);
```

$$SCHEQ3 := h \alpha e^{(-\alpha r(t))} \left( \frac{d}{dt} r(t) \right) - \alpha^2 e^{(-\alpha r(t))} - \frac{2 \alpha e^{(-\alpha r(t))}}{r(t)} + \frac{8 \pi^2 G M m^2 e^{(-\alpha r(t))}}{r(t) h^2}$$

```
> XX2:=factor(SCHEQ3);
```

$$XX2 := \frac{e^{(-\alpha r(t))} \left( h^3 \alpha \left( \frac{d}{dt} r(t) \right) r(t) - \alpha^2 r(t) h^2 - 2 \alpha h^2 + 8 \pi^2 G M m^2 \right)}{r(t) h^2}$$

```
>
```

> #From standard solution of gravitational Schrodinger equation, we know (Rubcic, Fizika 1998):  
 > SCHEQ4:=4\*pi^2\*G\*M\*m^2-h^2\*alpha;

$$SCHEQ4 := 4 \pi^2 G M m^2 - \alpha h^2$$

> a:=solve(SCHEQ4,alpha);

$$a := \frac{4 \pi^2 G M m^2}{h^2}$$

> #Gravitational Bohr radius is defined as inverse of alpha:  
 pha:

> gravBohrradius:=1/a;

$$gravBohrradius := \frac{h^2}{4 \pi^2 G M m^2}$$

> #Therefore time-dependent solution of Schrodinger equation may introduce new term to this gravitational Bohr radius.

> SCHEQ5:=(XX2\*(S\*h^2)/(exp(-(alpha\*S))))-2\*SCHEQ4;

$$SCHEQ5 := h^3 \alpha \left( \frac{d}{dt} r(t) \right) r(t) - \alpha^2 r(t) h^2$$

> #Then we shall assume for simplicity by assigning value to d[r(t)]/dt:

> D4R:=1;

$$D4R := 1$$

> Then we can solve again SCHEQ5 similar to solution of SCHEQ4 :

> a2:=solve((h^3\*alpha\*(D4R)\*S-alpha^2\*S\*h^2)+2\*SCHEQ4);

$$a2 := \{ \alpha = \alpha, \pi = \pi, m = m, h = h, G = G, M = M, \\ t = \text{RootOf}(r\_Z) \alpha h^3 - r\_Z) \alpha^2 h^2 + 8 \pi^2 G M m^2 - 2 \alpha h^2 \}, \\ \{ \alpha = 0, t = t, m = m, h = h, G = G, M = M, \pi = 0 \}, \\ \{ \alpha = 0, \pi = \pi, t = t, m = m, h = h, M = M, G = 0 \}, \\ \{ \alpha = \alpha, h = 0, t = t, m = m, G = G, M = M, \pi = 0 \},$$

$$\begin{aligned} & \{ \pi = \pi, t = t, m = m, h = h, M = M, \alpha = h, G = \frac{h^3}{4 \pi^2 M m^2} \}, \\ & \{ \alpha = \alpha, h = 0, \pi = \pi, t = t, m = m, M = M, G = 0 \}, \\ & \{ \alpha = 0, \pi = \pi, t = t, m = m, h = h, G = G, M = 0 \}, \\ & \{ \alpha = 0, \pi = \pi, t = t, h = h, G = G, M = M, m = 0 \}, \\ & \{ \alpha = \alpha, h = 0, \pi = \pi, t = t, m = m, G = G, M = 0 \}, \\ & \{ \alpha = \alpha, h = 0, \pi = \pi, t = t, G = G, M = M, m = 0 \} \end{aligned}$$

> gravBohrradius1:=1/(a2);

$$\begin{aligned} \text{gravBohrradius1} & := 1 / \left( \left\{ \alpha = \alpha, \pi = \pi, m = m, h = h, G = G, M = M, \right. \right. \\ & t = \text{RootOf}(r\_Z) \alpha h^3 - r\_Z \alpha^2 h^2 + 8 \pi^2 G M m^2 - 2 \alpha h^2 \left. \right\}, \\ & \{ \alpha = 0, t = t, m = m, h = h, G = G, M = M, \pi = 0 \}, \\ & \{ \alpha = 0, \pi = \pi, t = t, m = m, h = h, M = M, G = 0 \}, \\ & \{ \alpha = \alpha, h = 0, t = t, m = m, G = G, M = M, \pi = 0 \}, \\ & \left. \left\{ \pi = \pi, t = t, m = m, h = h, M = M, \alpha = h, G = \frac{h^3}{4 \pi^2 M m^2} \right\}, \right. \\ & \{ \alpha = \alpha, h = 0, \pi = \pi, t = t, m = m, M = M, G = 0 \}, \\ & \{ \alpha = 0, \pi = \pi, t = t, m = m, h = h, G = G, M = 0 \}, \\ & \{ \alpha = 0, \pi = \pi, t = t, h = h, G = G, M = M, m = 0 \}, \\ & \{ \alpha = \alpha, h = 0, \pi = \pi, t = t, m = m, G = G, M = 0 \}, \\ & \left. \left. \{ \alpha = \alpha, h = 0, \pi = \pi, t = t, G = G, M = M, m = 0 \} \right) \right) \end{aligned}$$

> #Comparing our gravitational Bohr radius to the standard grav Bohr radius yield modification factor, called here chi-factor:

> chi:=gravBohrradius\*(1+gravBohrradius1/gravBohrradius);

$$\begin{aligned} \chi & := \frac{1}{4} h^2 \left( 1 + 4 \pi^2 G M m^2 / \left( \left\{ \alpha = \alpha, \pi = \pi, m = m, h = h, G = G, M = M, \right. \right. \right. \\ & t = \text{RootOf}(r\_Z) \alpha h^3 - r\_Z \alpha^2 h^2 + 8 \pi^2 G M m^2 - 2 \alpha h^2 \left. \right\}, \\ & \{ \alpha = 0, t = t, m = m, h = h, G = G, M = M, \pi = 0 \}, \\ & \{ \alpha = 0, \pi = \pi, t = t, m = m, h = h, M = M, G = 0 \}, \\ & \{ \alpha = \alpha, h = 0, t = t, m = m, G = G, M = M, \pi = 0 \}, \\ & \left. \left\{ \pi = \pi, t = t, m = m, h = h, M = M, \alpha = h, G = \frac{h^3}{4 \pi^2 M m^2} \right\}, \right. \\ & \left. \left. \{ \alpha = \alpha, h = 0, \pi = \pi, t = t, m = m, M = M, G = 0 \} \right) \right) \end{aligned}$$



### Appendix A.3. Time-independent gravitational Schrödinger equation with Yukawa potential [5]

```
> #Extension of gravitational Schrodinger equation (Rub-
cic, Fizika 1998);
> restart;
> #departure from newton potential;
> R:=exp(-(alpha*r));
```

$$R := e^{(-\alpha r)}$$

```
> D1R:=diff(R,r); D2R:=diff(D1R,r);
```

$$D1R := -\alpha e^{(-\alpha r)}$$

$$D2R := \alpha^2 e^{(-\alpha r)}$$

```
>
```

```
> SCHEQ2:=D2R+D1R*2/r+8*pi^2*(G*M-K*exp(-
2*mu)*(1+mu*r))*m^2*R/(r*h^2)=0;
```

$$SCHEQ2 := \alpha^2 e^{(-\alpha r)} - \frac{2 \alpha e^{(-\alpha r)}}{r} + \frac{8 \pi^2 (GM - K e^{(-2\mu)} (1 + \mu r)) m^2 e^{(-\alpha r)}}{r h^2} = 0$$

```
> XX2:=factor(SCHEQ2);
```

```
XX2 := -
```

$$\frac{e^{(-\alpha r)} (-\alpha^2 r h^2 + 2 \alpha h^2 - 8 \pi^2 m^2 GM + 8 \pi^2 m^2 K e^{(-2\mu)} + 8 \pi^2 m^2 K e^{(-2\mu)} \mu r)}{r h^2} = 0$$

```
> RR:=solve(XX2,r);
```

$$RR := \frac{2 (-\alpha h^2 + 4 \pi^2 m^2 GM - 4 \pi^2 m^2 K e^{(-2\mu)})}{-\alpha^2 h^2 + 8 \pi^2 m^2 K e^{(-2\mu)} \mu}$$

```
> #from standard gravitational Schrodinger equation we
know:
```

```
> SCHEQ3:=4*pi^2*G*M*m^2-h^2*alpha=0;
```

>

$$SCHEQ3 := 4 \pi^2 G M m^2 - h^2 \alpha = 0$$

> a:=solve(SCHEQ3,alpha);

$$a := \frac{4 \pi^2 G M m^2}{h^2}$$

>#Gravitational Bohr radius is defined as inverse of alpha:

> gravBohrradius:=1/a;

$$gravBohrradius := \frac{h^2}{4 \pi^2 G M m^2}$$

>#Therefore we conclude that the new terms of RR shall yield new terms (YY) into this gravitational Bohr radius:

> PI:=(RR\*(alpha^2\*h^2)-(-8\*pi^2\*G\*M\*m^2+2\*h^2\*alpha));

$$\Pi := \frac{2(-\alpha h^2 + 4 \pi^2 m^2 G M - 4 \pi^2 m^2 K e^{(-2\mu)}) \alpha^2 h^2}{-\alpha^2 h^2 + 8 \pi^2 m^2 K e^{(-2\mu)} \mu} + 8 \pi^2 m^2 G M - 2 \alpha h^2$$

>#This new term induced by pion condensation via Gross-Pitaevskii equation may be observed in the form of long-range potential effect. (see Moffat, J., arXiv:astro-ph/0602607, 2006; also F. Smarandache & V. Christianto, Progress in Physics, Vol. 2 no. 2, 2006, & Vol. 3 no. 1, 2007, www.ptep-online.com)

>#We can also solve directly :

> SCHEQ5:=RR\*(alpha^2\*h^2)/2;

$$SCHEQ5 := \frac{(-\alpha h^2 + 4 \pi^2 m^2 G M - 4 \pi^2 m^2 K e^{(-2\mu)}) \alpha^2 h^2}{-\alpha^2 h^2 + 8 \pi^2 m^2 K e^{(-2\mu)} \mu}$$

> a1:=solve(SCHEQ5,alpha);

$$a1 := 0, 0, \frac{4 \pi^2 m^2 (G M - K e^{(-2\mu)})}{h^2}$$

> #Then one finds modified gravitational Bohr radius in  
the form:

> modifgravBohrradius:=1/(4\*pi^2\*(G\*M-  
K\*exp(-2\*mu))\*m^2/h^2);

$$\text{modifgravBohrradius} := \frac{1}{4} \frac{h^2}{\pi^2 m^2 (GM - K e^{(-2\mu)})}$$

> #This modification can be expressed in  
chi-factor:

> chi:=modifgravBohrradius/gravBohrradius;

$$\chi := \frac{GM}{GM - K e^{(-2\mu)}}$$



**Appendix A.4. Coupled time-independent gravitational Schrödinger equation (Bogoliubov-deGennes)**

```
> #Solution of gravitational Schrodinger equation (Rub-
cic, Fizika 1998);
```

```
> restart;
```

```
> with(DEtools):
```

```
> #without time evolution, Bogoliubov-deGennes method
(version3);
```

```
> R:=exp(-(alpha*r));
```

$$R := e^{(-\alpha r)}$$

```
> D1R:=diff(R,r); D2R:=diff(D1R,r);
```

$$D1R := -\alpha e^{(-\alpha r)}$$

$$D2R := \alpha^2 e^{(-\alpha r)}$$

```
> #Using simplified terms only from equation (A*8), time-
independent Schrodinger equation with BOgoliubov deGennes
method (TISE)
```

```
> ODESCHEQ2:=D2R+D1R*2/r+8*pi^2*G*M*m^2*R/(r*h^2);
```

$$ODESCHEQ2 := \alpha^2 e^{(-\alpha r)} - \frac{2 \alpha e^{(-\alpha r)}}{r} + \frac{8 \pi^2 G M m^2 e^{(-\alpha r)}}{r h^2}$$

```
> Ar := ma-
```

```
trix(2,2,[8*pi^2*G*M*m^2*R/(r*h^2),D2R+D1R*2/r,+D2R+D1R*2
/r,-8*pi^2*G*M*m^2*R/(r*h^2)]);
```

$$Ar := \begin{bmatrix} \frac{8 \pi^2 G M m^2 e^{(-\alpha r)}}{r h^2} & \alpha^2 e^{(-\alpha r)} - \frac{2 \alpha e^{(-\alpha r)}}{r} \\ \alpha^2 e^{(-\alpha r)} - \frac{2 \alpha e^{(-\alpha r)}}{r} & -\frac{8 \pi^2 G M m^2 e^{(-\alpha r)}}{r h^2} \end{bmatrix}$$

```
>
```

> Br := matrix(2,1,[f(r),g(r)]);

$$Br := \begin{bmatrix} f(r) \\ g(r) \end{bmatrix}$$

> solr := matrixDE(Ar,Br,r);

$$solr := \left[ \begin{array}{l} \left[ \text{DESol} \left( \left\{ - \left( - \left( \frac{d^2}{dr^2} Y(r) \right) r^3 h^4 \alpha + 2 \left( \frac{d^2}{dr^2} Y(r) \right) r^2 h^4 + 2 \left( \frac{d}{dr} Y(r) \right) r h^4 \right. \right. \right. \\ - \left( \frac{d}{dr} Y(r) \right) r^3 h^4 \alpha^2 + 2 \left( \frac{d}{dr} Y(r) \right) r^2 h^4 \alpha \\ - 8 e^{(-2\alpha r)} Y(r) \pi^2 G M m^2 \alpha e^{(\alpha r)} r h^2 + 64 e^{(-2\alpha r)} Y(r) \pi^4 G^2 M^2 m^4 \alpha r \\ - 128 e^{(-2\alpha r)} Y(r) \pi^4 G^2 M^2 m^4 + e^{(-2\alpha r)} Y(r) \alpha^5 h^4 r^3 \\ - 6 e^{(-2\alpha r)} Y(r) \alpha^4 h^4 r^2 + 12 e^{(-2\alpha r)} Y(r) \alpha^3 h^4 r - 8 e^{(-2\alpha r)} Y(r) \alpha^2 h^4 \\ - 2 e^{(-\alpha r)} r h^4 f(r) e^{(\alpha r)} + e^{(-\alpha r)} r^3 h^4 f(r) \alpha^2 e^{(\alpha r)} - 2 e^{(-\alpha r)} r^2 h^4 f(r) \alpha e^{(\alpha r)} \\ + e^{(-\alpha r)} r^3 h^4 \left( \frac{d}{dr} f(r) \right) \alpha e^{(\alpha r)} - 2 e^{(-\alpha r)} r^2 h^4 \left( \frac{d}{dr} f(r) \right) e^{(\alpha r)} \\ + 8 e^{(-\alpha r)} r^2 h^2 \pi^2 G M m^2 f(r) \alpha - 16 e^{(-\alpha r)} r h^2 \pi^2 G M m^2 f(r) \\ + e^{(-\alpha r)} r^3 h^4 \alpha^3 g(r) - 4 e^{(-\alpha r)} r^2 h^4 \alpha^2 g(r) + 4 e^{(-\alpha r)} r h^4 \alpha g(r) \left. \right) / (r^2 h^4 \\ (\alpha r - 2) \left. \right\}, \{ Y(r) \} \right] \\ \left[ \left( -8 \pi^2 G M m^2 \text{DESol} \left( \left\{ - \left( - \left( \frac{d^2}{dr^2} Y(r) \right) r^3 h^4 \alpha + 2 \left( \frac{d^2}{dr^2} Y(r) \right) r^2 h^4 \right. \right. \right. \right. \right. \\ + 2 \left( \frac{d}{dr} Y(r) \right) r h^4 - \left( \frac{d}{dr} Y(r) \right) r^3 h^4 \alpha^2 + 2 \left( \frac{d}{dr} Y(r) \right) r^2 h^4 \alpha \\ - 8 e^{(-2\alpha r)} Y(r) \pi^2 G M m^2 \alpha e^{(\alpha r)} r h^2 + 64 e^{(-2\alpha r)} Y(r) \pi^4 G^2 M^2 m^4 \alpha r \\ - 128 e^{(-2\alpha r)} Y(r) \pi^4 G^2 M^2 m^4 + e^{(-2\alpha r)} Y(r) \alpha^5 h^4 r^3 \\ - 6 e^{(-2\alpha r)} Y(r) \alpha^4 h^4 r^2 + 12 e^{(-2\alpha r)} Y(r) \alpha^3 h^4 r - 8 e^{(-2\alpha r)} Y(r) \alpha^2 h^4 \\ - 2 e^{(-\alpha r)} r h^4 f(r) e^{(\alpha r)} + e^{(-\alpha r)} r^3 h^4 f(r) \alpha^2 e^{(\alpha r)} - 2 e^{(-\alpha r)} r^2 h^4 f(r) \alpha e^{(\alpha r)} \\ + e^{(-\alpha r)} r^3 h^4 \left( \frac{d}{dr} f(r) \right) \alpha e^{(\alpha r)} - 2 e^{(-\alpha r)} r^2 h^4 \left( \frac{d}{dr} f(r) \right) e^{(\alpha r)} \\ + 8 e^{(-\alpha r)} r^2 h^2 \pi^2 G M m^2 f(r) \alpha - 16 e^{(-\alpha r)} r h^2 \pi^2 G M m^2 f(r) \\ + e^{(-\alpha r)} r^3 h^4 \alpha^3 g(r) - 4 e^{(-\alpha r)} r^2 h^4 \alpha^2 g(r) + 4 e^{(-\alpha r)} r h^4 \alpha g(r) \left. \right) / (r^2 h^4 \end{array} \right]$$

$$\begin{aligned}
& (\alpha r - 2))\}, \{_{-}Y(r)\} \Big) + r e^{(\alpha r)} \left( \frac{d}{dr} \text{DESol} \left( \left\{ - \left( - \left( \frac{d^2}{dr^2} _{-}Y(r) \right) r^3 h^4 \alpha \right. \right. \right. \right. \\
& + 2 \left( \frac{d^2}{dr^2} _{-}Y(r) \right) r^2 h^4 + 2 \left( \frac{d}{dr} _{-}Y(r) \right) r h^4 - \left( \frac{d}{dr} _{-}Y(r) \right) r^3 h^4 \alpha^2 \\
& + 2 \left( \frac{d}{dr} _{-}Y(r) \right) r^2 h^4 \alpha - 8 e^{(-2\alpha r)} _{-}Y(r) \pi^2 G M m^2 \alpha e^{(\alpha r)} r h^2 \\
& + 64 e^{(-2\alpha r)} _{-}Y(r) \pi^4 G^2 M^2 m^4 \alpha r - 128 e^{(-2\alpha r)} _{-}Y(r) \pi^4 G^2 M^2 m^4 \\
& + e^{(-2\alpha r)} _{-}Y(r) \alpha^5 h^4 r^3 - 6 e^{(-2\alpha r)} _{-}Y(r) \alpha^4 h^4 r^2 + 12 e^{(-2\alpha r)} _{-}Y(r) \alpha^3 h^4 r \\
& - 8 e^{(-2\alpha r)} _{-}Y(r) \alpha^2 h^4 - 2 e^{(-\alpha r)} r h^4 f(r) e^{(\alpha r)} + e^{(-\alpha r)} r^3 h^4 f(r) \alpha^2 e^{(\alpha r)} \\
& - 2 e^{(-\alpha r)} r^2 h^4 f(r) \alpha e^{(\alpha r)} + e^{(-\alpha r)} r^3 h^4 \left( \frac{d}{dr} f(r) \right) \alpha e^{(\alpha r)} \\
& - 2 e^{(-\alpha r)} r^2 h^4 \left( \frac{d}{dr} f(r) \right) e^{(\alpha r)} + 8 e^{(-\alpha r)} r^2 h^2 \pi^2 G M m^2 f(r) \alpha \\
& - 16 e^{(-\alpha r)} r h^2 \pi^2 G M m^2 f(r) + e^{(-\alpha r)} r^3 h^4 \alpha^3 g(r) - 4 e^{(-\alpha r)} r^2 h^4 \alpha^2 g(r) \\
& \left. + 4 e^{(-\alpha r)} r h^4 \alpha g(r) \right) / (r^2 h^4 (\alpha r - 2))\}, \{_{-}Y(r)\} \Big) \Big) h^2 \Big) / (\alpha (\alpha r - 2) h^2) \Big], \\
& \left[ 0, - \frac{r e^{(\alpha r)} f(r)}{\alpha (\alpha r - 2)} \right]
\end{aligned}$$

>#Note that this result is very different from standard solution of gravitation Schrodinger equation described by Nottale or Rubcic&Rubcic (1998):

$$a := \frac{4 \pi^2 G M m^2}{h^2}$$

## Quantization in Astrophysics, Brownian Motion, and Supersymmetry

The present book discusses, among other things, various quantization phenomena found in Astrophysics and some related issues including Brownian Motion. With recent discoveries of exoplanets in our galaxy and beyond, this Astrophysics quantization issue has attracted numerous discussions in the past few years.

Most chapters in this book come from published papers in various peer-reviewed journals, and they cover different methods to describe quantization, including Weyl geometry, Supersymmetry, generalized Schrödinger, and Cartan torsion method. In some chapters Navier-Stokes equations are also discussed, because it is likely that this theory will remain relevant in Astrophysics and Cosmology

While much of the arguments presented in this book are theoretical, nonetheless we recommend further observation in order to verify or refute the propositions described herein. It is of our hope that this volume could open a new chapter in our knowledge on the formation and structure of Astrophysical systems.

The present book is also intended for young physics and math fellows who perhaps will find the arguments described here are at least worth pondering.

